

• General Description

It combines advanced trench MOSFET technology with a low resistance package to provide extremely low $R_{DS(ON)}$.

• Features

- Advance high cell density Trench technology
- Low $R_{DS(ON)}$ to minimize conductive loss
- Low Gate Charge for fast switching
- Low Thermal resistance

• Application

- MB/VGA Vcore
- SMPS 2nd Synchronous Rectifier
- POL application
- BLDC Motor driver

• Product Summary

$V_{DS} = 30V$

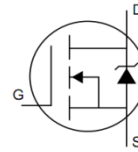

$R_{DS(ON)} = 9.8m\Omega$

$I_D = 8A$

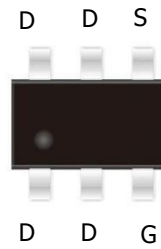
SOT23-6
• Ordering Information:

Part NO.	ZM095N03U
Marking	095N03
Packing Information	REEL TAPE
Basic ordering unit (pcs)	3000

• Absolute Maximum Ratings (T_c =25°C)

Parameter	Symbol	Rating	Unit
Drain-Source Voltage	V_{DS}	30	V
Gate-Source Voltage	V_{GS}	±20	V
Continuous Drain Current	$I_{D@TC=25^{\circ}C}$	8	A
	$I_{D@TC=75^{\circ}C}$	6	A
	$I_{D@TC=100^{\circ}C}$	5	A
Pulsed Drain Current ①	I_{DM}	24	A
Total Power Dissipation②	$P_D@TC=25^{\circ}C$	2.1	W
Total Power Dissipation(TA=25°C)	$P_D@TA=25^{\circ}C$	1.25	W
Operating Junction Temperature	T_J	-55 to 150	°C
Storage Temperature	T_{STG}	-55 to 150	°C

•Thermal resistance

Parameter	Symbol	Min.	Typ.	Max.	Unit
Thermal resistance, junction - case ^②	R _{thJC}	-	-	60	° C/W
Thermal resistance, junction - ambient	R _{thJA}	-	-	100	° C/W
Soldering temperature, wavesoldering for 10s	T _{sold}	-	-	265	° C

•Electronic Characteristics

Parameter	Symbol	Condition	Min.	Typ	Max.	Unit
Drain-Source Breakdown Voltage	BV _{DSS}	V _{GS} =0V, I _D =250uA	30			V
Gate Threshold Voltage	V _{GS(TH)}	V _{GS} =V _{DS} , I _D =250uA	1.2		2.5	V
Drain-Source Leakage Current	I _{DSS}	V _{DS} =30V, V _{GS} =0V			1.0	uA
Gate- Source Leakage Current	I _{GSS}	V _{GS} =±12V, V _{DS} =0V			±100	nA
Static Drain-source On Resistance	R _{DS(ON)}	V _{GS} =10V, I _D =8A		9.8	12.5	mΩ
		V _{GS} =4.5V, I _D =6A		13	17	mΩ
Forward Transconductance	g _{FS}	V _{DS} =10V, I _D =5A		9		s
Source-drain voltage	VSD	I _s =10A			1.28	V

•Electronic Characteristics

Parameter	Symbol	Condition	Min.	Typ	Max.	Unit
Input capacitance	C _{iss}	f = 1MHz	-	850	-	pF
Output capacitance	C _{oss}		-	190	-	
Reverse transfer capacitance	C _{rss}		-	100	-	

•Gate Charge characteristics(T_a = 25°C)

Parameter	Symbol	Condition	Min.	Typ	Max.	Unit
Total gate charge	Q _g	V _{DD} =25V	-	12	-	nC
Gate - Source charge	Q _{gs}	I _D = 8A	-	4	-	
Gate - Drain charge	Q _{gd}	V _{GS} = 10V	-	8	-	

Note: ① Pulse Test : Pulse width ≤ 300μs, Duty cycle ≤ 2% ;

② Device mounted on FR-4 substrate PC board, 2oz copper, with thermal bias to bottom layer 1inch square copper plate;

Fig.1 Gate-Charge Characteristics

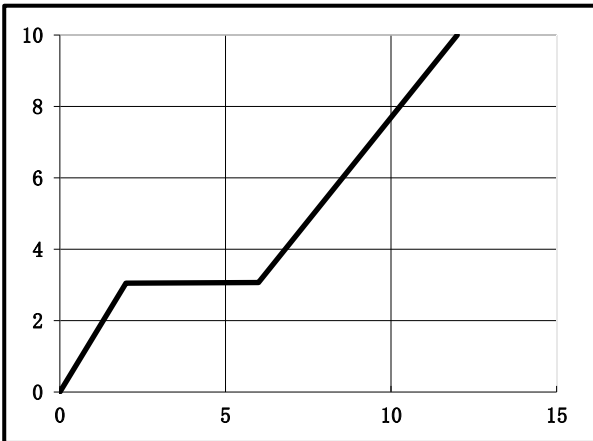

Fig.2 Capacitance Characteristics

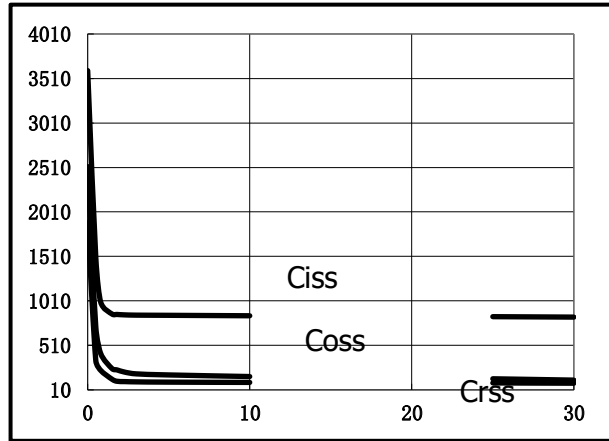

Fig.3 Power Dissipation Derating Curve

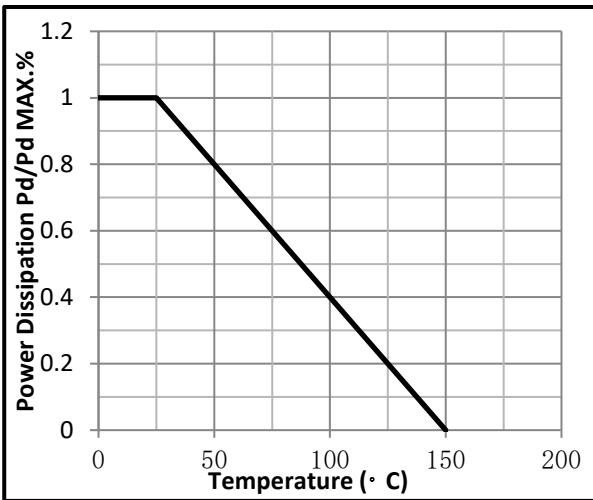

Fig.4 Typical output Characteristics

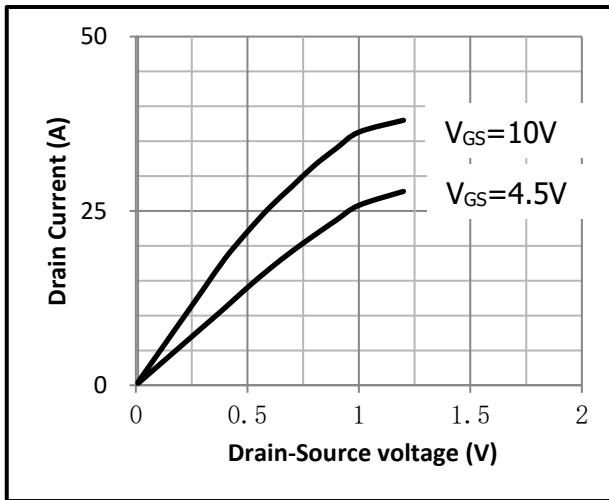

Fig.5 Threshold Voltage V.S Junction Temperature

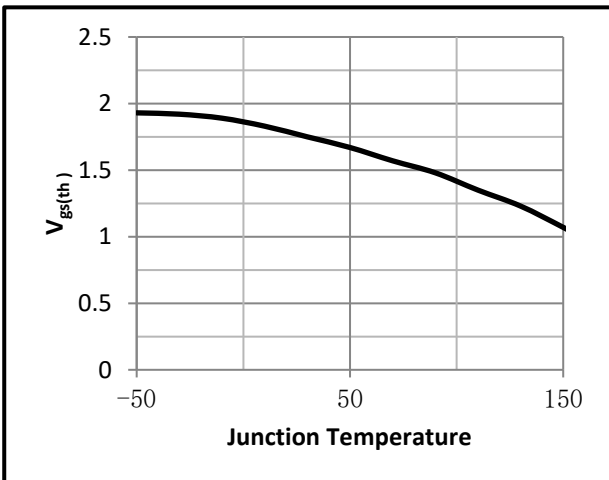

Fig.6 Resistance V.S Drain Current

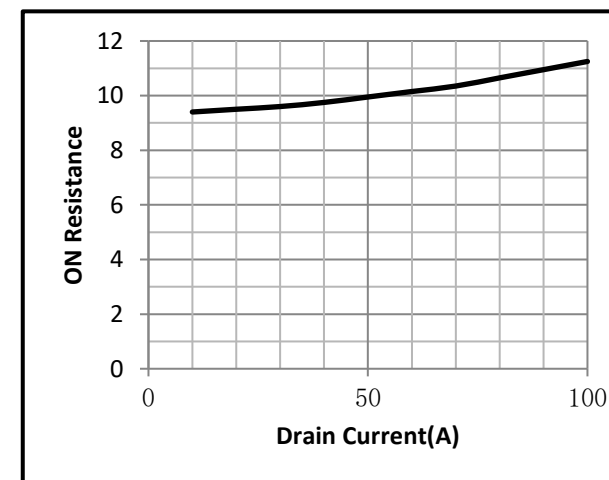

Fig.7 On-Resistance VS Gate Source Voltage

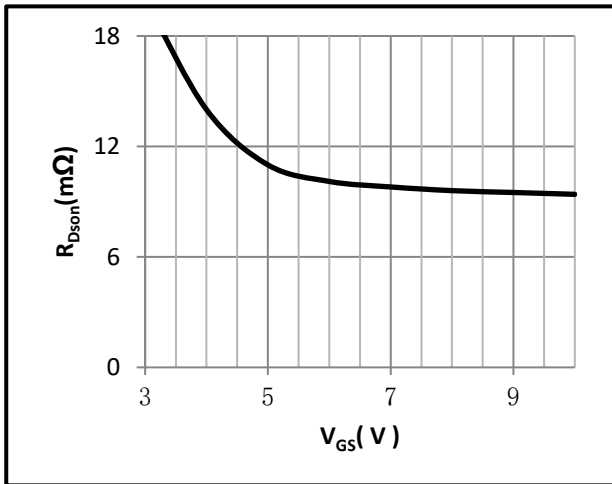

Fig.8 On-Resistance V.S Junction Temperature

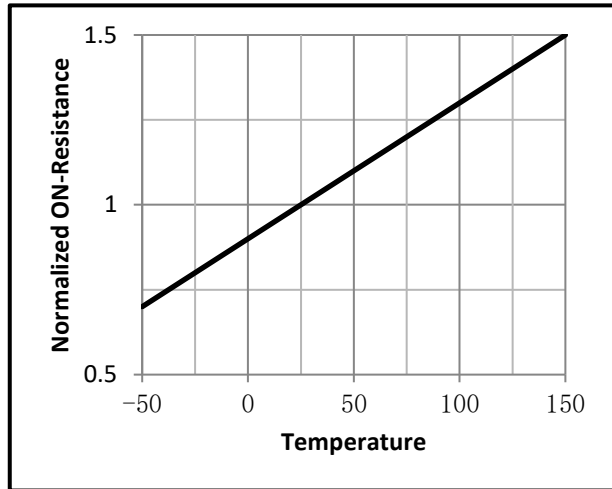

Fig.9 Switching Time Measurement Circuit

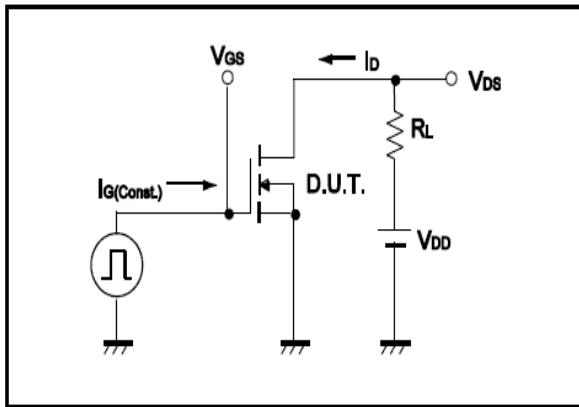

Fig.10 Gate Charge Waveform

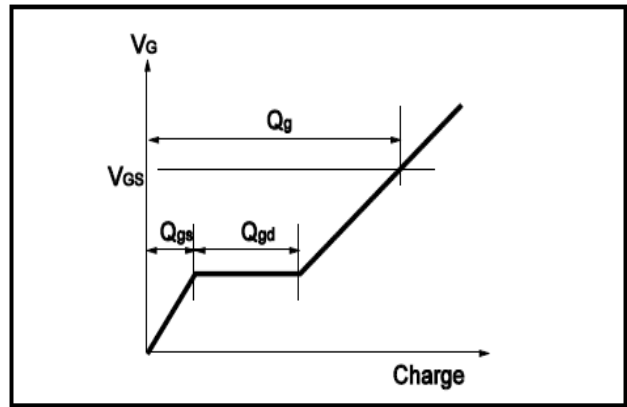

Fig.11 Switching Time Measurement Circuit

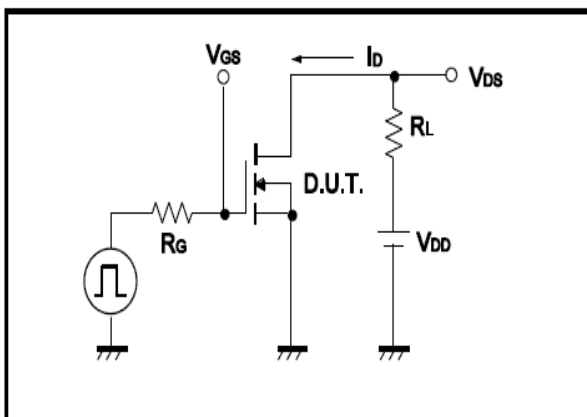
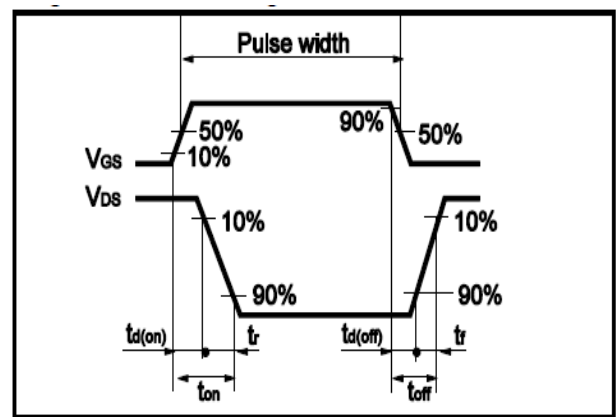

Fig.12 Gate Charge Waveform



•Dimensions(SOT23-6)

Unit: mm

