

• General Description

The ZM040N06HP combines advanced trench MOSFET technology with a low resistance package to provide extremely low $R_{DS(ON)}$.

• Features

- Advance high cell density Trench technology
- Low $R_{DS(ON)}$ to minimize conductive loss
- Low Gate Charge for fast switching
- Low Thermal resistance

• Application

- SMPS 2nd Synchronous Rectifier
- BLDC Motor driver

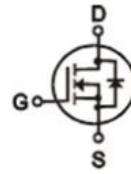
• Product Summary

$V_{DS} = 60V$

$R_{DS(ON)} = 4.5m\Omega$

$I_D = 120A$

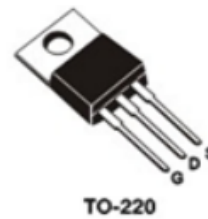
• Ordering Information:

Part NO.	ZM040N06HP
Marking	ZM040N06H
Packing Information	Bulk Tube
Basic ordering unit (pcs)	500

• Absolute Maximum Ratings ($T_C = 25^\circ C$)

Parameter	Symbol	Rating	Unit
Drain-Source Voltage	V_{DS}	60	V
Gate-Source Voltage	V_{GS}	± 20	V
Continuous Drain Current	$I_D @ TC=25^\circ C$	120	A
	$I_D @ TC=75^\circ C$	91.2	A
	$I_D @ TC=100^\circ C$	75.6	A
Pulsed Drain Current ^①	I_{DM}	250	A
Total Power Dissipation($TC=25^\circ C$)	$P_D @ TC=25^\circ C$	120	W
Total Power Dissipation($TA=25^\circ C$)	$P_D @ TA=25^\circ C$	5	W
Operating Junction Temperature	T_J	-55 to 150	$^\circ C$
Storage Temperature	T_{STG}	-55 to 150	$^\circ C$

•Thermal resistance

Parameter	Symbol	Min.	Typ.	Max.	Unit
Thermal resistance, junction - case	R_{thJC}	-	-	1	° C/W
Thermal resistance, junction - ambient	R_{thJA}	-	-	25	° C/W
Soldering temperature, wavesoldering for 10s	T_{sold}	-	-	265	° C

•Electronic Characteristics

Parameter	Symbol	Condition	Min.	Typ	Max.	Unit
Drain-Source Breakdown Voltage	BV_{DSS}	$V_{GS} = 0V, I_D = 250\mu A$	60			V
Gate Threshold Voltage	$V_{GS(TH)}$	$V_{GS} = V_{DS}, I_D = 250\mu A$	2		4	V
Drain-Source Leakage Current	I_{DSS}	$V_{DS} = 60V, V_{GS} = 0V$			1.0	μA
Gate- Source Leakage Current	I_{GSS}	$V_{GS} = \pm 20V, V_{DS} = 0V$			± 100	nA
Static Drain-source On Resistance	$R_{DS(ON)}$	$V_{GS} = 10V, I_D = 16A$		4.5	6	m Ω
Forward Transconductance	g_{FS}	$V_{DS} = 25V, I_D = 15A$		32		S
Source-drain voltage	V_{SD}	$I_S = 16A$			1.28	V

•Electronic Characteristics

Parameter	Symbol	Condition	Min.	Typ	Max.	Unit
Input capacitance	C_{iss}	f = 1MHz	-	6510	-	pF
Output capacitance	C_{oss}		-	450	-	
Reverse transfer capacitance	C_{rss}		-	200	-	

•Gate Charge characteristics($T_a = 25^\circ C$)

Parameter	Symbol	Condition	Min.	Typ	Max.	Unit
Total gate charge	Q_g	$V_{DD} = 25V$	-	54	-	nC
Gate - Source charge	Q_{gs}	$I_D = 20A$	-	18	-	
Gate - Drain charge	Q_{gd}	$V_{GS} = 10V$	-	21	-	

Note: ① Pulse Test : Pulse width $\leq 300\mu s$, Duty cycle $\leq 2\%$;

Fig.1 Gate-Charge Characteristics

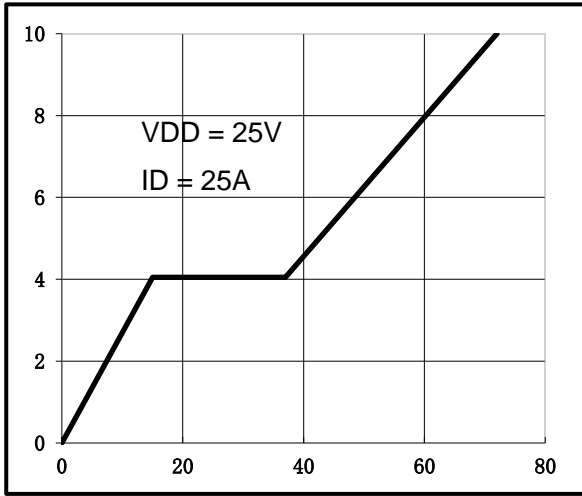

Fig.2 Capacitance Characteristics

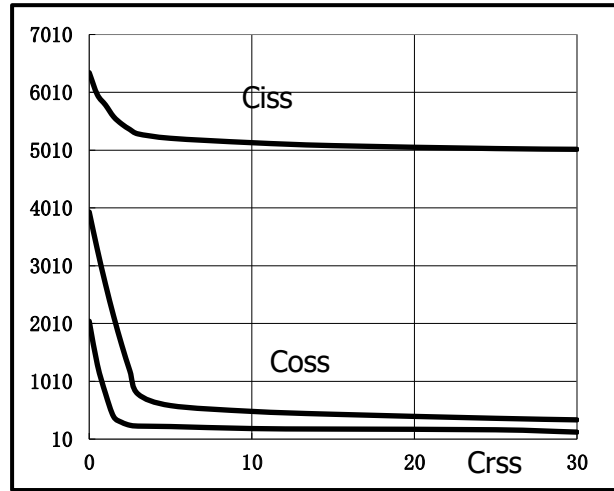

Fig.3 Power Dissipation

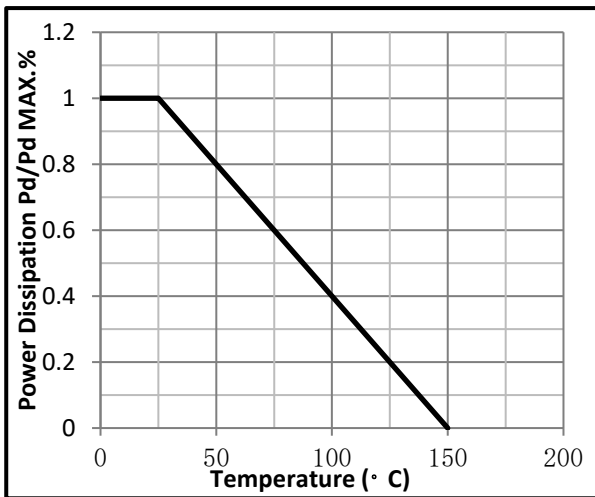

Fig.4 Typical output Characteristics

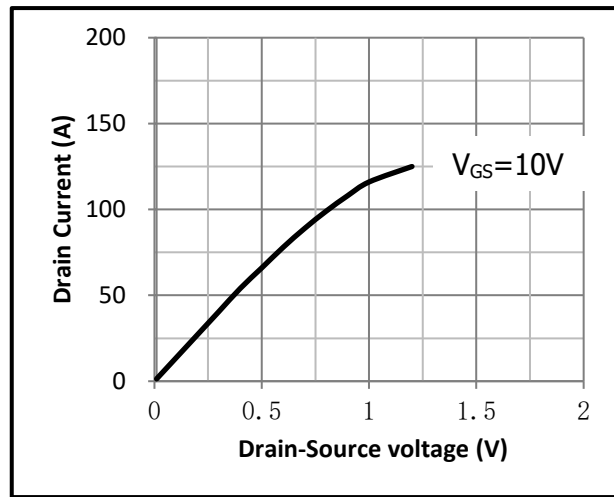

Fig.5 Threshold Voltage V.S Junction Temperature

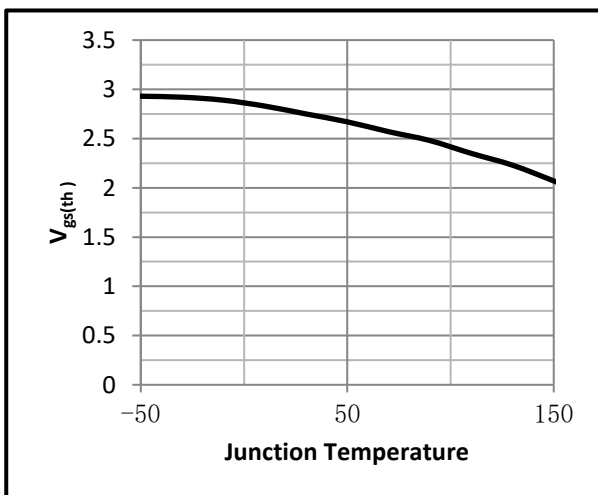

Fig.6 Resistance V.S Drain Current

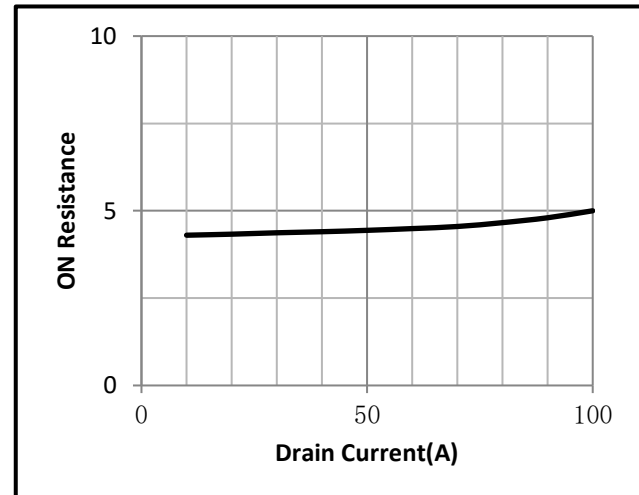

Fig.7 On-Resistance VS Gate Source Voltage

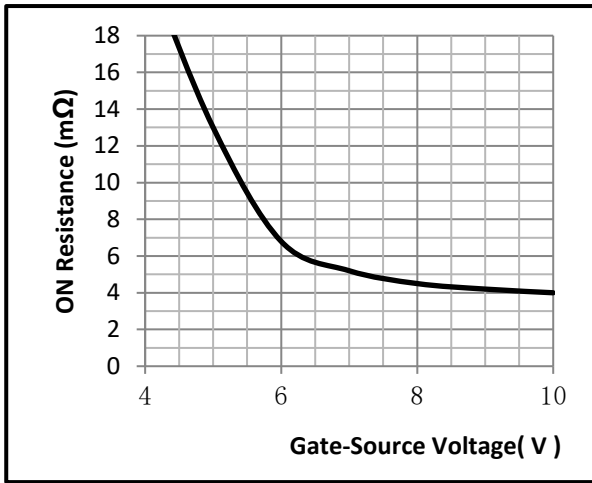

Fig.8 On-Resistance V.S Junction Temperature

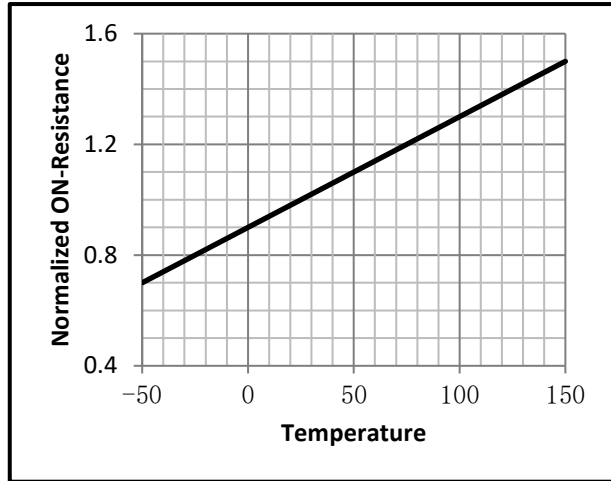

Fig.9 Switching Time Measurement Circuit

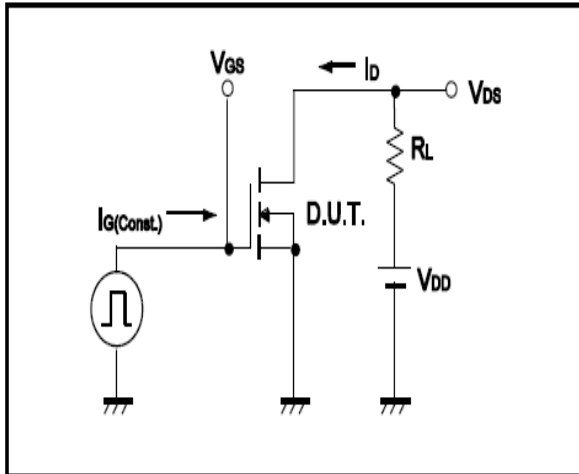

Fig.10 Gate Charge Waveform

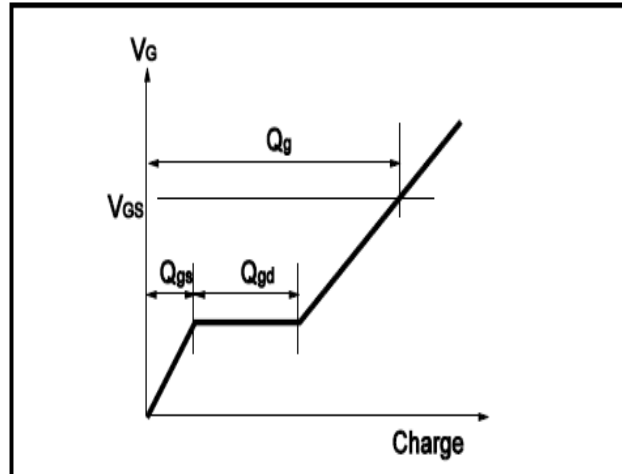

Fig.11 Switching Time Measurement Circuit

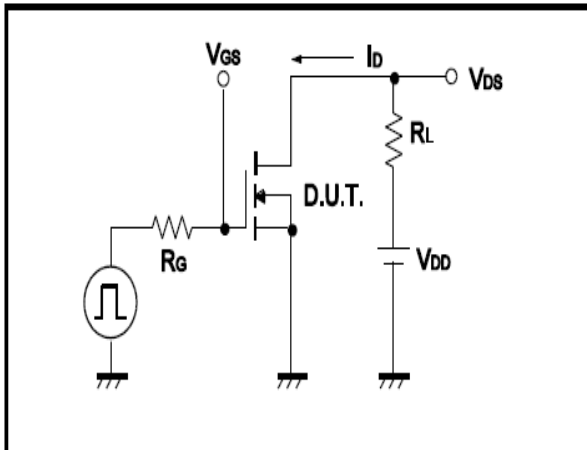
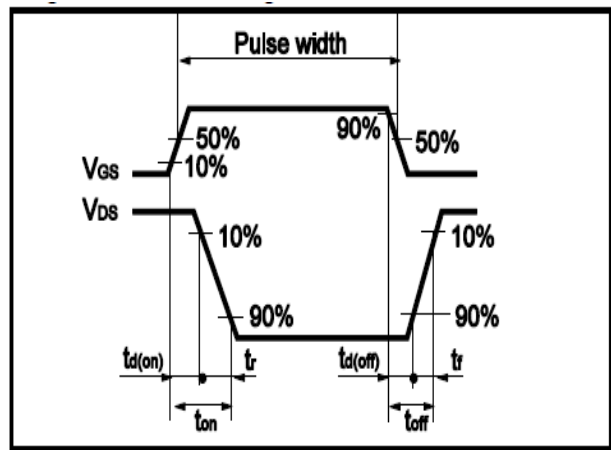

Fig.12 Gate Charge Waveform



•Dimensions (TO-220)

Unit: mm

SYMBOL	min	max	SYMBOL	min	max
A	2.10	2.50	B	0.85	1.25
b	0.50	0.80	b1	0.50	0.90
b2	0.45	0.70	C	0.45	0.70
D	6.30	6.75	D1	5.10	5.50
E	5.30	6.30	e1	2.25	2.35
L1	9.20	10.60	e2	4.45	4.75
L2	0.90	1.75	L3	0.60	1.10
K	0.00	0.23			

