

• General Description

The ZM040N06HN combines advanced trench MOSFET technology with a low resistance package to provide extremely low $R_{DS(ON)}$.

• Features

- Advance high cell density Trench technology
- Low $R_{DS(ON)}$ to minimize conductive loss
- Low Gate Charge for fast switching
- Low Thermal resistance

• Application

- Synchronous Rectification for AC-DC/DC-DC converter
- Oring switches
- BLDC Motor driver

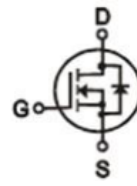
• Product Summary

$V_{DS} = 60V$

$R_{DS(ON)} = 4m\Omega$

$I_D = 100A$

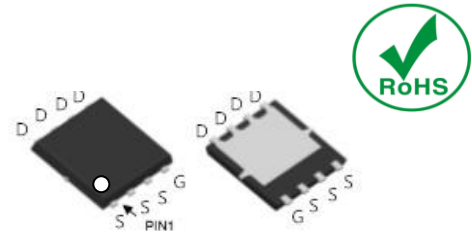
DFN5 x 6
• Ordering Information:

Part NO.	ZM040N06HN
Marking	ZM040N06H
Packing Information	REEL TAPE
Basic ordering unit (pcs)	3000

• Absolute Maximum Ratings ($T_C = 25^\circ C$)

Parameter	Symbol	Rating	Unit
Drain-Source Voltage	V_{DS}	60	V
Gate-Source Voltage	V_{GS}	± 20	V
Continuous Drain Current	$I_{D@TC=25^\circ C}$	100	A
	$I_{D@TC=75^\circ C}$	76	A
	$I_{D@TC=100^\circ C}$	63	A
Pulsed Drain Current ①	I_{DM}	260	A
Total Power Dissipation($TC=25^\circ C$)	$P_D@TC=25^\circ C$	85	W
Total Power Dissipation($TA=25^\circ C$)	$P_D@TA=25^\circ C$	3.4	W
Operating Junction Temperature	T_J	-55 to 150	$^\circ C$
Storage Temperature	T_{STG}	-55 to 150	$^\circ C$
Single Pulse Avalanche Energy@ $L=0.1mH$	E_{AS}	180	mJ
Avalanche Current@ $L=0.1mH$	I_{AS}	60	A

•Thermal resistance

Parameter	Symbol	Min.	Typ.	Max.	Unit
Thermal resistance, junction - case	R_{thJC}	-	-	1.5	$^{\circ}C/W$
Thermal resistance, junction - ambient	R_{thJA}	-	-	37	$^{\circ}C/W$
Soldering temperature, wave soldering for 10s	T_{sold}	-	-	265	$^{\circ}C$

•Electronic Characteristics

Parameter	Symbol	Condition	Min.	Typ	Max.	Unit
Drain-Source Breakdown Voltage	BV_{DSS}	$V_{GS}=0V, I_D=250\mu A$	60			V
Gate Threshold Voltage	$V_{GS(TH)}$	$V_{GS}=V_{DS}, I_D=250\mu A$	2		4	V
Drain-Source Leakage Current	I_{DSS}	$V_{DS}=60V, V_{GS}=0V$			1.0	μA
Gate- Source Leakage Current	I_{GSS}	$V_{GS}=\pm 20V, V_{DS}=0V$			± 100	nA
Static Drain-source On Resistance	$R_{DS(ON)}$	$V_{GS}=10V, I_D=20A$		4	6	m Ω
Forward Transconductance	g_{FS}	$V_{DS}=25V, I_D=15A$		32		s
Source-drain voltage	V_{SD}	$I_S=20A$			1.28	V

•Electronic Characteristics

Parameter	Symbol	Condition	Min.	Typ	Max.	Unit
Input capacitance	C_{iss}	$V_{GS}=0V, V_{DS}=30V$ $f = 1MHz$	-	6510	-	pF
Output capacitance	C_{oss}		-	450	-	
Reverse transfer capacitance	C_{rss}		-	200	-	

•Gate Charge characteristics($T_a = 25^{\circ}C$)

Parameter	Symbol	Condition	Min.	Typ	Max.	Unit
Total gate charge	Q_g	$V_{DD} = 30V$ $I_D = 25A$ $V_{GS} = 10V$	-	54	-	nC
Gate - Source charge	Q_{gs}		-	18	-	
Gate - Drain charge	Q_{gd}		-	21	-	

Note: ① Pulse Test : Pulse width $\leq 300\mu s$, Duty cycle $\leq 2\%$;

Fig.1 Gate-Charge Characteristics

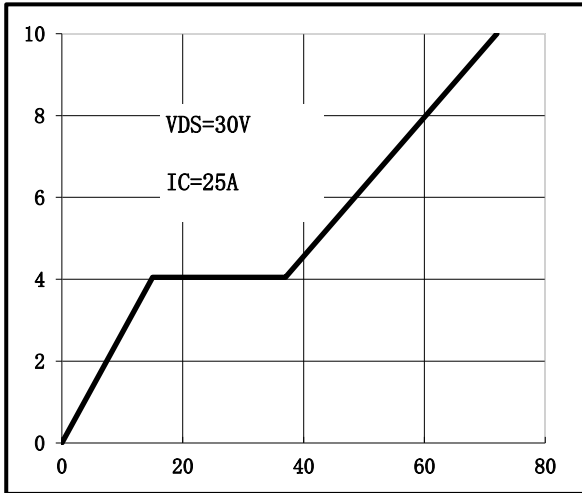

Fig.2 Capacitance Characteristics

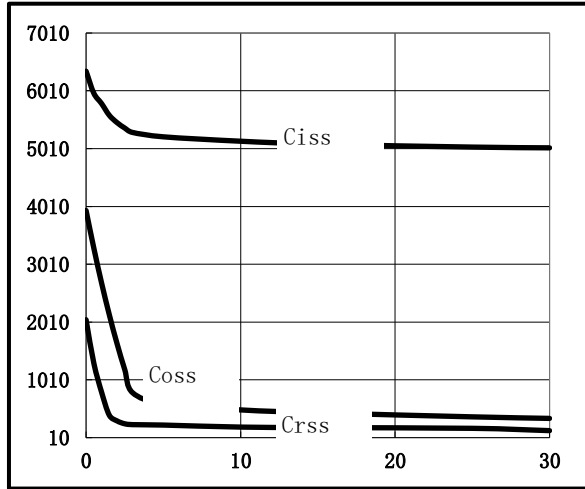

Fig.3 Power Dissipation

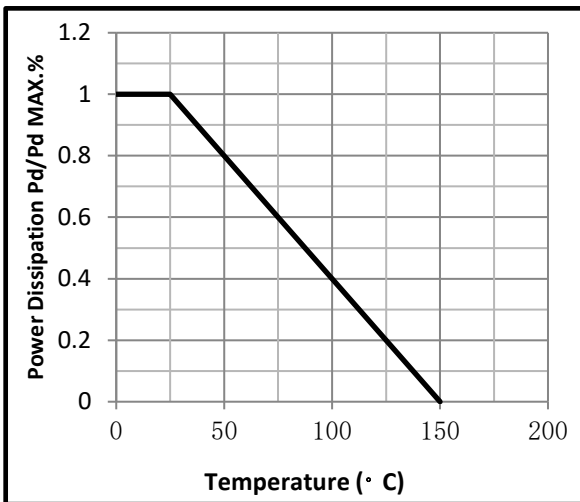

Fig.4 Typical output Characteristics

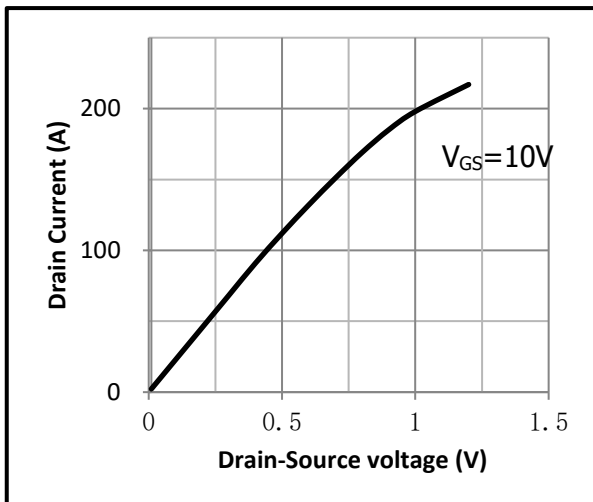

Fig.5 Threshold Voltage V.S Junction Temperature

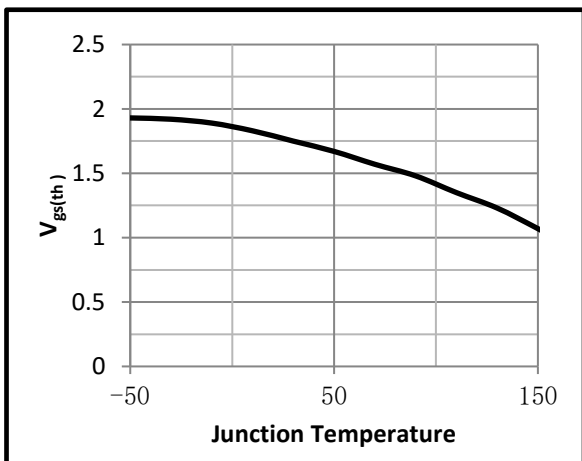

Fig.6 Resistance V.S Drain Current

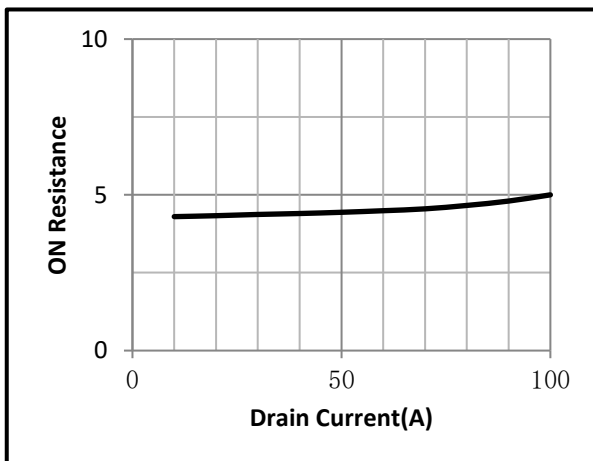

Fig.7 On-Resistance VS Gate Source Voltage

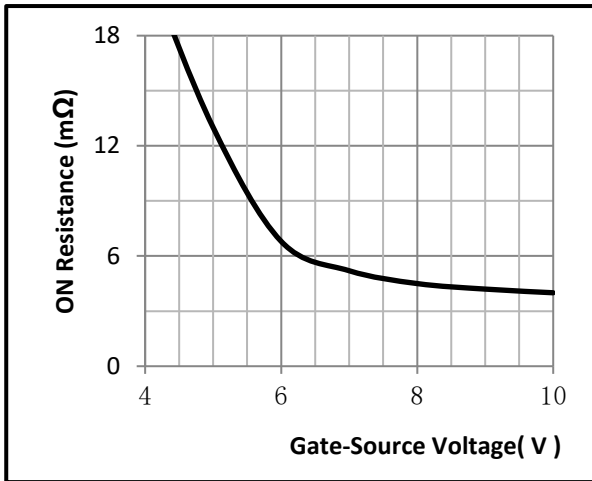

Fig.8 On-Resistance V.S Junction Temperature

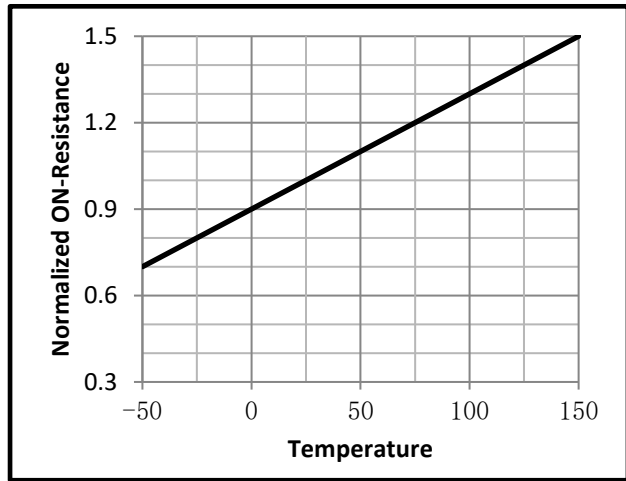

Fig.9 Switching Time Measurement Circuit

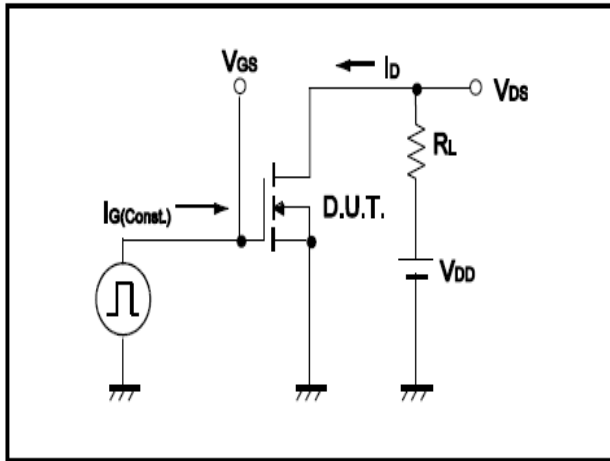

Fig.10 Gate Charge Waveform

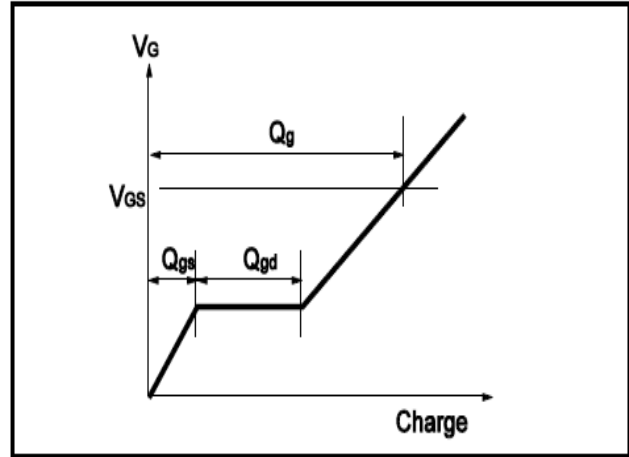

Fig.11 Switching Time Measurement Circuit

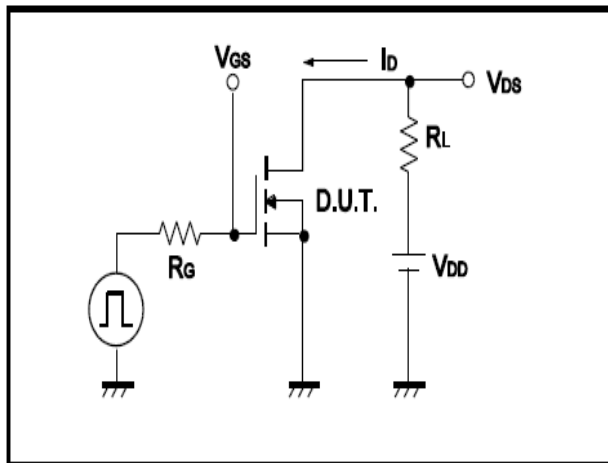
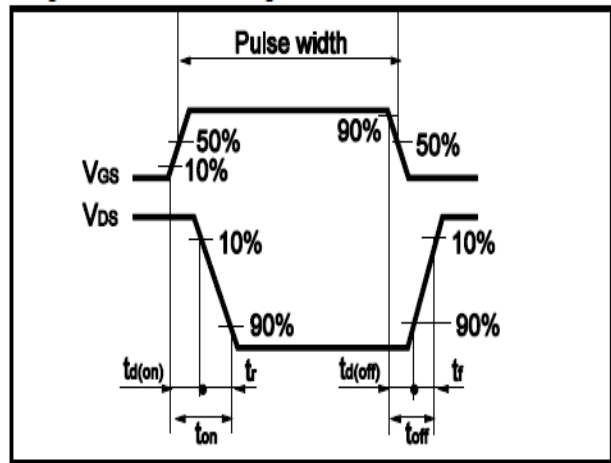

Fig.12 Gate Charge Waveform





•Dimensions (DFN5×6)

Unit: mm

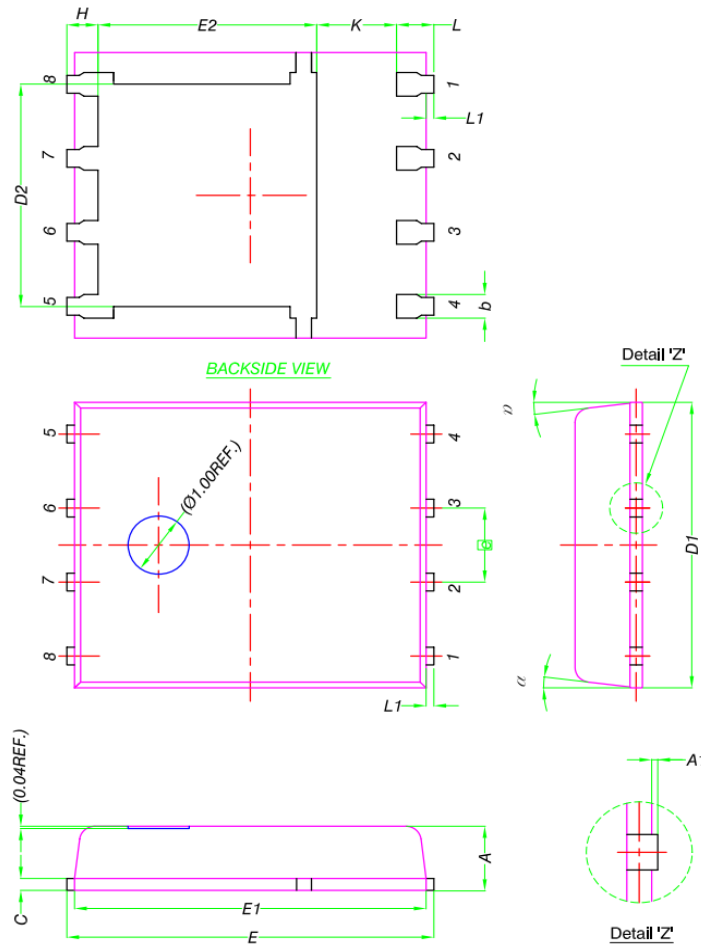

DIM.	MILLIMETERS		
	MIN.	NOM.	MAX.
A	0.90	1.00	1.10
A1	0	-	0.05
b	0.33	0.41	0.51
C	0.20	0.25	0.30
D1	4.80	4.90	5.00
D2	3.61	3.81	3.96
E	5.90	6.00	6.10
E1	5.70	5.75	5.80
E2	3.38	3.58	3.78
e	1.27 BSC		
H	0.41	0.51	0.61
K	1.10	-	-
L	0.51	0.61	0.71
L1	0.06	0.13	0.20
α	0°	-	12°