

• General Description

The ZM085N03L combines advanced trench MOSFET technology with a low resistance package to provide extremely low $R_{DS(ON)}$.

• Features

- Advance high cell density Trench technology
- Low $R_{DS(ON)}$ to minimize conductive loss
- Low Gate Charge for fast switching
- Low Thermal resistance

• Application

- MB/VGA Vcore
- SMPS 2nd Synchronous Rectifier
- POL application
- BLDC Motor driver

• Product Summary

$V_{DS} = 30V$

$R_{DS(ON)} = 8.5m\Omega$

$I_D = 15A$

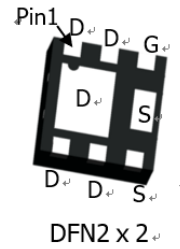
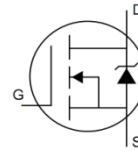
• Ordering Information:

Part NO.	ZM085N03L
Marking	085N03
Packing Information	REEL TAPE
Basic ordering unit (pcs)	3000

• Absolute Maximum Ratings ($T_c = 25^\circ C$)

Parameter	Symbol	Rating	Unit
Drain-Source Voltage	V_{DS}	30	V
Gate-Source Voltage	V_{GS}	± 20	V
Continuous Drain Current	$I_{D@TC=25^\circ C}$	15	A
	$I_{D@TC=75^\circ C}$	11	A
	$I_{D@TC=100^\circ C}$	9.5	A
Pulsed Drain Current ^①	I_{DM}	30	A
Total Power Dissipation ^②	P_D	15	W
Total Power Dissipation($T_A=25^\circ C$)	$P_D@T_A=25^\circ C$	1.3	W
Operating Junction Temperature	T_J	-55 to 150	$^\circ C$
Storage Temperature	T_{STG}	-55 to 150	$^\circ C$

•Thermal resistance

Parameter	Symbol	Min.	Typ.	Max.	Unit
Thermal resistance, junction - case ^②	R _{thJC}	-	-	8	° C/W
Thermal resistance, junction - ambient	R _{thJA}	-	-	95	° C/W
Soldering temperature, wavesoldering for 10s	T _{sold}	-	-	265	° C

•Electronic Characteristics

Parameter	Symbol	Condition	Min.	Typ	Max.	Unit
Drain-Source Breakdown Voltage	BV _{DSS}	V _{GS} =0V, I _D =250uA	30			V
Gate Threshold Voltage	V _{GS(TH)}	V _{GS} =V _{DS} , I _D =250uA	1.3	1.7	2.5	V
Drain-Source Leakage Current	I _{DSS}	V _{DS} =30V, V _{GS} =0V			1.0	uA
Gate- Source Leakage Current	I _{GSS}	V _{GS} =±20V, V _{DS} =0V			±100	nA
Static Drain-source On Resistance	R _{DS(ON)}	V _{GS} =4.5V, I _D =15A		8.5	11	mΩ
		V _{GS} =2.5V, I _D =10A		10	13	mΩ
Forward Transconductance	g _{FS}	V _{DS} =10V, I _D =5A		8		s
Source-drain voltage	V _{SD}	I _s =15A			1.28	V

•Electronic Characteristics

Parameter	Symbol	Condition	Min.	Typ	Max.	Unit
Input capacitance	C _{iss}	f = 1MHz	-	1200	-	pF
Output capacitance	C _{oss}		-	235	-	
Reverse transfer capacitance	C _{rss}		-	120	-	

•Gate Charge characteristics(T_a = 25°C)

Parameter	Symbol	Condition	Min.	Typ	Max.	Unit
Total gate charge	Q _g	V _{DD} =15V	-	12	-	nC
Gate - Source charge	Q _{gs}	I _D = 4A	-	4	-	
Gate - Drain charge	Q _{gd}	V _{GS} = 10V	-	6	-	

Note: ① Pulse Test : Pulse width ≤ 300μs, Duty cycle ≤ 2% ;

② Device mounted on FR-4 substrate PC board, 2oz copper, with thermal bias to bottom layer 1inch square copper plate;

Fig.1 Gate-Charge Characteristics

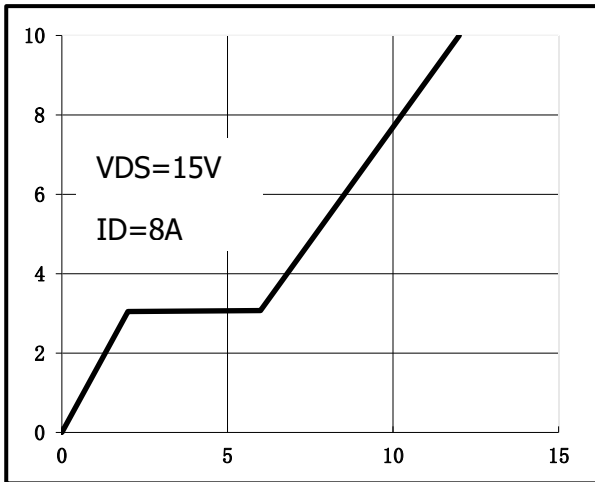

Fig.2 Capacitance Characteristics

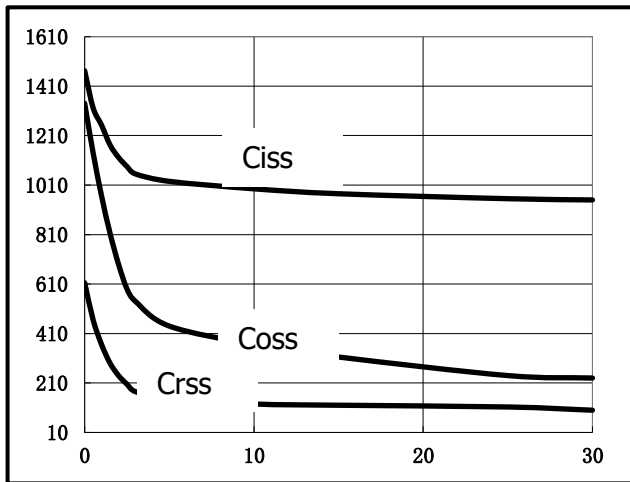

Fig.3 Power Dissipation Derating Curve

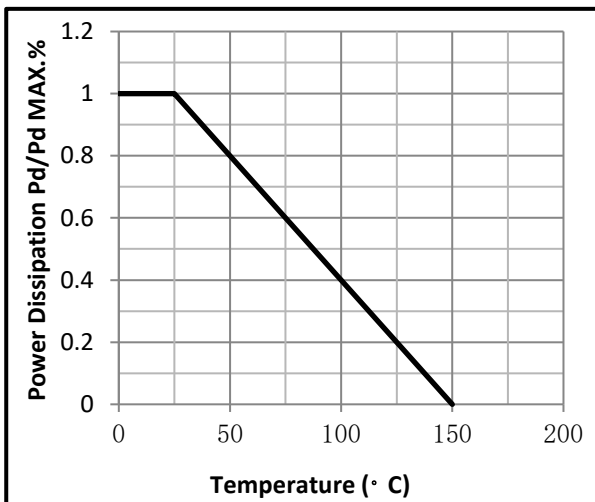

Fig.4 Typical output Characteristics

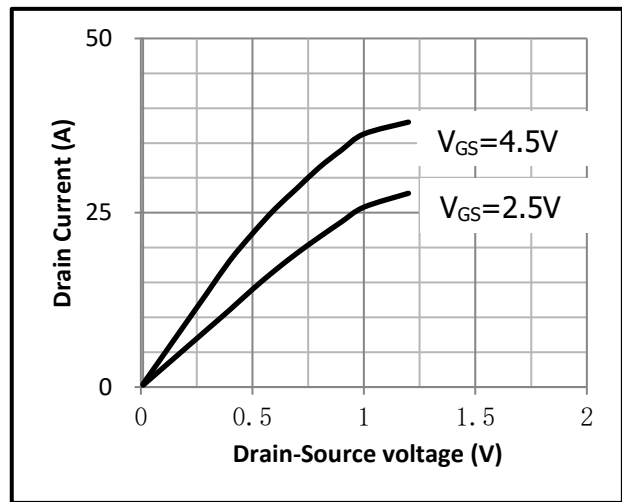

Fig.5 Threshold Voltage V.S Junction Temperature

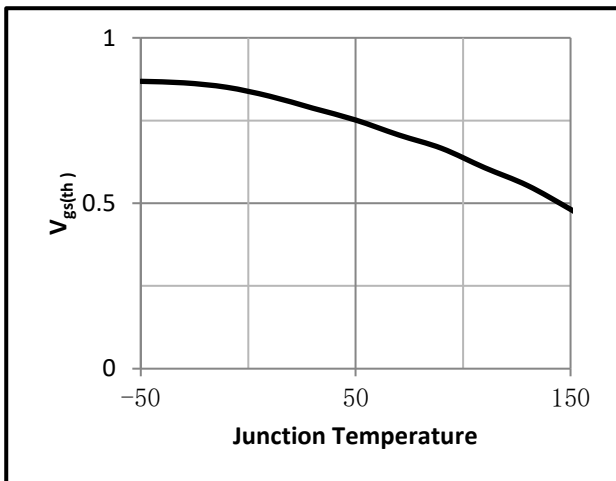

Fig.6 Resistance V.S Drain Current

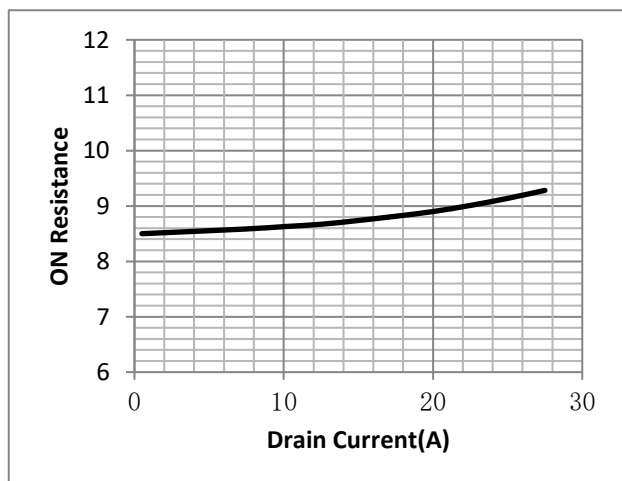

Fig.7 On-Resistance VS Gate Source Voltage

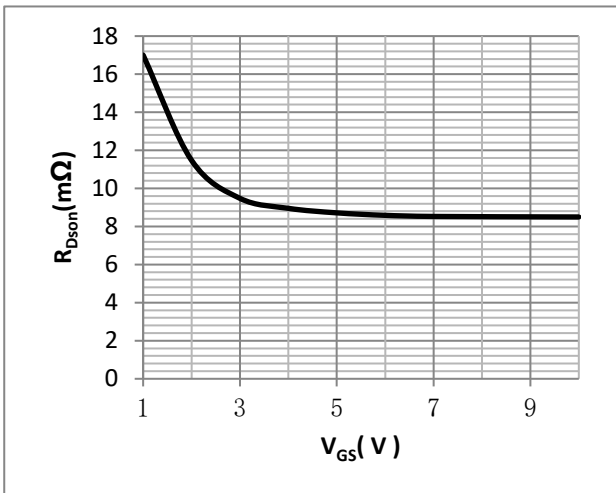

Fig.8 On-Resistance V.S Junction Temperature

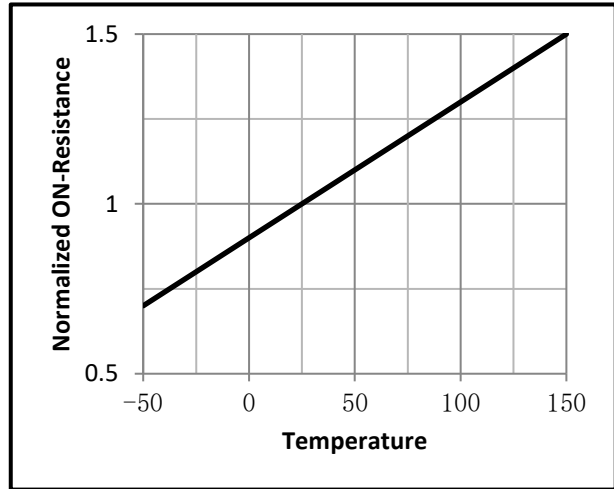

Fig.9 Switching Time Measurement Circuit

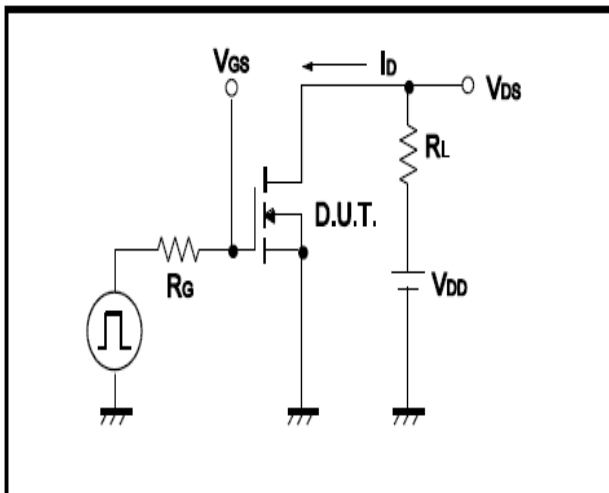

Fig.10 Gate Charge Waveform

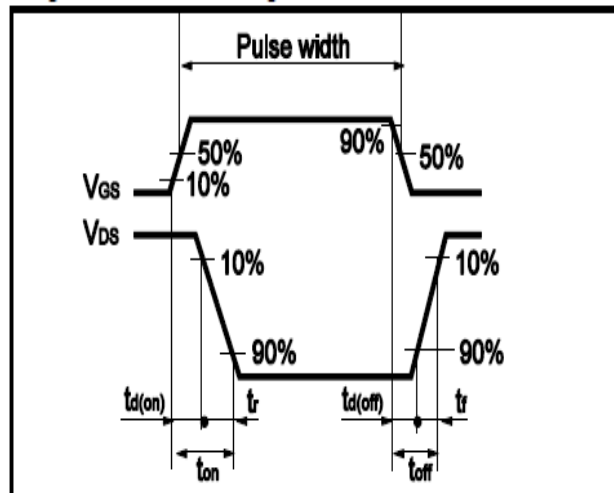

Fig.11 Avalanche Measurement Circuit

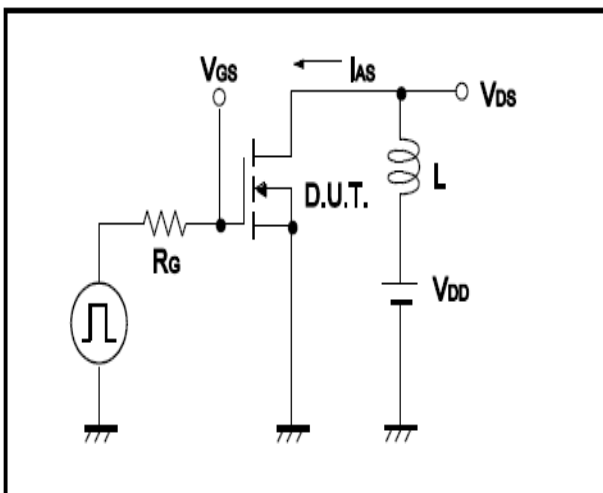
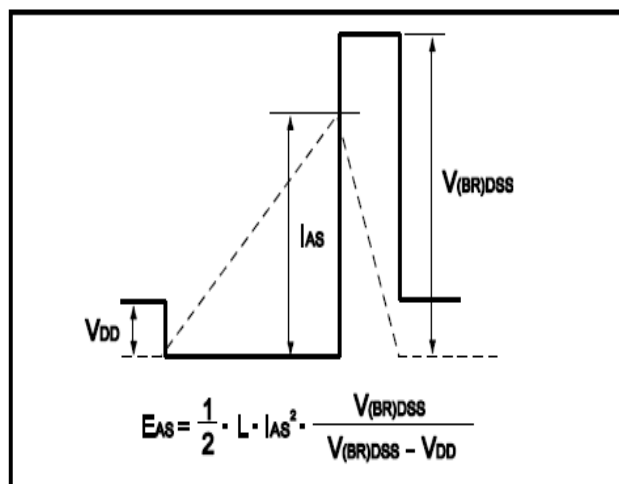
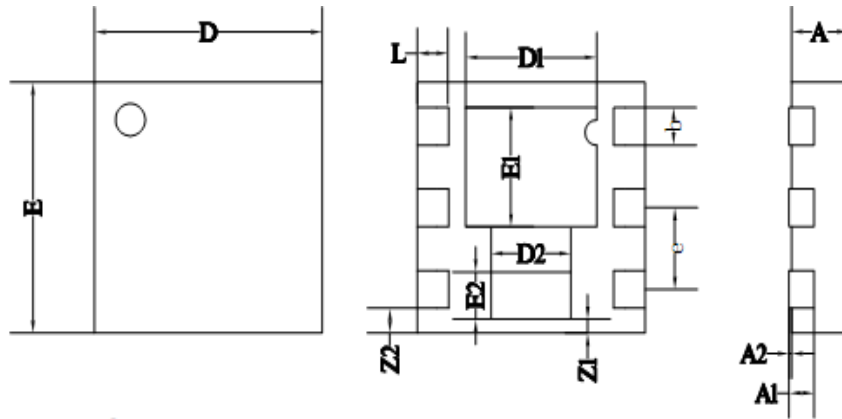

Fig.12 Avalanche Waveform



•Dimensions(DFN2*2)

Unit: mm



NOTE:
 All dimensions are in mm

	MIN	NOM	MAX
D	1.95	2.00	2.05
E	1.95	2.00	2.05
D1	1.10	1.15	1.20
E1	0.90	0.95	1.00
D2	0.65	0.70	0.75
E2	0.33	0.38	0.43
L	0.225	0.275	0.325
b	0.25	0.30	0.35
e	0.65BSC		
A	0.45	0.50	0.55
A1	0.20REF		
A2	0.00	-	0.05
Z1	0.06	0.11	0.16
Z2	0.15	0.20	0.25