

**• General Description**

The ZM100N02T combines advanced trench MOSFET technology with a low resistance package to provide extremely low  $R_{DS(ON)}$ .

**• Features**

- Advance high cell density Trench technology
- Low  $R_{DS(ON)}$  to minimize conductive loss
- Low Gate Charge for fast switching
- Low Thermal resistance

**• Application**

- MB/VGA Vcore
- SMPS 2<sup>nd</sup> Synchronous Rectifier
- POL application
- BLDC Motor driver

**• Product Summary**

$V_{DS} = 20V$

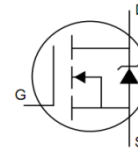

$R_{DS(ON)} = 13m\Omega$

$I_D = 10A$

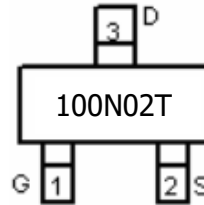

SOT23-3

**• Ordering Information:**

Part NO.	ZM100N02T
Marking	ZM100N02
Packing Information	REEL TAPE
Basic ordering unit (pcs)	3000

**• Absolute Maximum Ratings ( $T_c = 25^\circ C$ )**

Parameter	Symbol	Rating	Unit
Drain-Source Voltage	$V_{DS}$	20	V
Gate-Source Voltage	$V_{GS}$	$\pm 12$	V
Continuous Drain Current	$I_{D@TC=25^\circ C}$	10	A
	$I_{D@TC=75^\circ C}$	7.6	A
	$I_{D@TC=100^\circ C}$	6.3	A
Pulsed Drain Current <sup>①</sup>	$I_{DM}$	46	A
Total Power Dissipation <sup>②</sup>	$P_D$	10	W
Total Power Dissipation( $T_A=25^\circ C$ )	$P_D@T_A=25^\circ C$	0.7	W
Operating Junction Temperature	$T_J$	-55 to 150	$^\circ C$
Storage Temperature	$T_{STG}$	-55 to 150	$^\circ C$

**•Thermal resistance**

Parameter	Symbol	Min.	Typ.	Max.	Unit
Thermal resistance, junction - case <sup>②</sup>	R <sub>thJC</sub>	-	-	13	° C/W
Thermal resistance, junction - ambient	R <sub>thJA</sub>	-	-	180	° C/W
Soldering temperature, wavesoldering for 10s	T <sub>sold</sub>	-	-	265	° C

**•Electronic Characteristics**

Parameter	Symbol	Condition	Min.	Typ	Max.	Unit
Drain-Source Breakdown Voltage	BV <sub>DSS</sub>	V <sub>GS</sub> =0V, I <sub>D</sub> =250uA	20			V
Gate Threshold Voltage	V <sub>GS(TH)</sub>	V <sub>GS</sub> =V <sub>DS</sub> , I <sub>D</sub> =250uA	0.5	0.8	1.2	V
Drain-Source Leakage Current	I <sub>DSS</sub>	V <sub>DS</sub> =20V, V <sub>GS</sub> =0V			1.0	uA
Gate- Source Leakage Current	I <sub>GSS</sub>	V <sub>GS</sub> =±12V, V <sub>DS</sub> =0V			±100	nA
Static Drain-source On Resistance	R <sub>DS(ON)</sub>	V <sub>GS</sub> =4.5V, I <sub>D</sub> =8A		13	16	mΩ
		V <sub>GS</sub> =2.5V, I <sub>D</sub> =6A		16	19	mΩ
Forward Transconductance	g <sub>FS</sub>	V <sub>DS</sub> =10V, I <sub>D</sub> =5A		8		s
Source-drain voltage	V <sub>SD</sub>	I <sub>S</sub> =8A			1.28	V

**•Electronic Characteristics**

Parameter	Symbol	Condition	Min.	Typ	Max.	Unit
Input capacitance	C <sub>iss</sub>	f = 1MHz	-	950	-	pF
Output capacitance	C <sub>oss</sub>		-	230	-	
Reverse transfer capacitance	C <sub>rss</sub>		-	100	-	

**•Gate Charge characteristics(T<sub>a</sub> = 25°C)**

Parameter	Symbol	Condition	Min.	Typ	Max.	Unit
Total gate charge	Q <sub>g</sub>	V <sub>DD</sub> =15V	-	12	-	nC
Gate - Source charge	Q <sub>gs</sub>	I <sub>D</sub> = 8A	-	4	-	
Gate - Drain charge	Q <sub>gd</sub>	V <sub>GS</sub> = 10V	-	6	-	

Note: ① Pulse Test : Pulse width ≤ 300μs, Duty cycle ≤ 2% ;

② Device mounted on FR-4 substrate PC board, 2oz copper, with thermal bias to bottom layer 1inch square copper plate;

Fig.1 Gate-Charge Characteristics

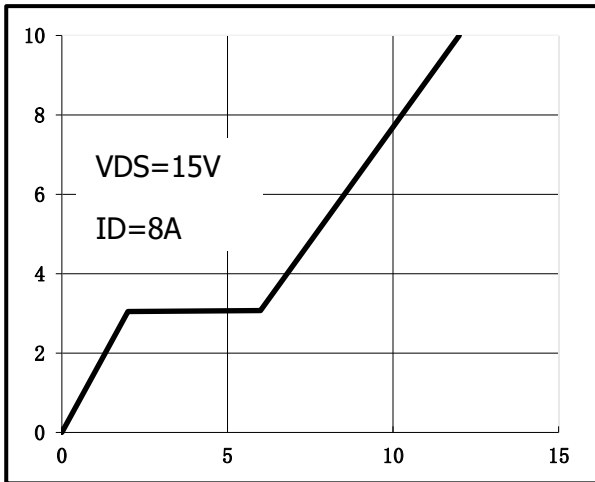

Fig.2 Capacitance Characteristics

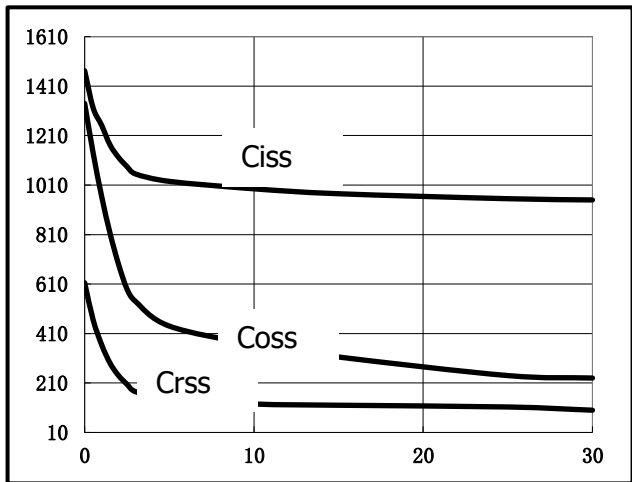

Fig.3 Power Dissipation Derating Curve

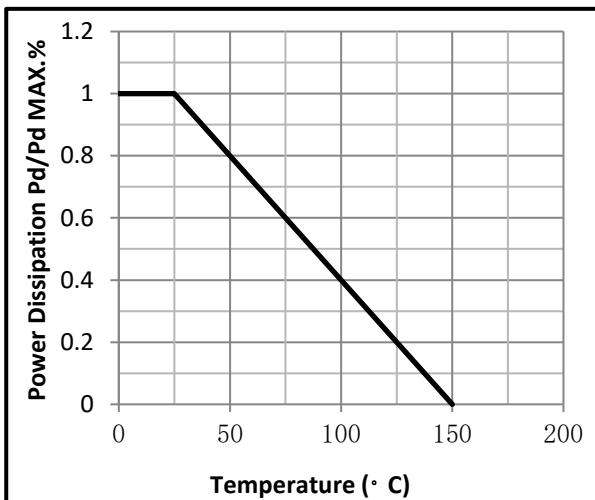

Fig.4 Typical output Characteristics

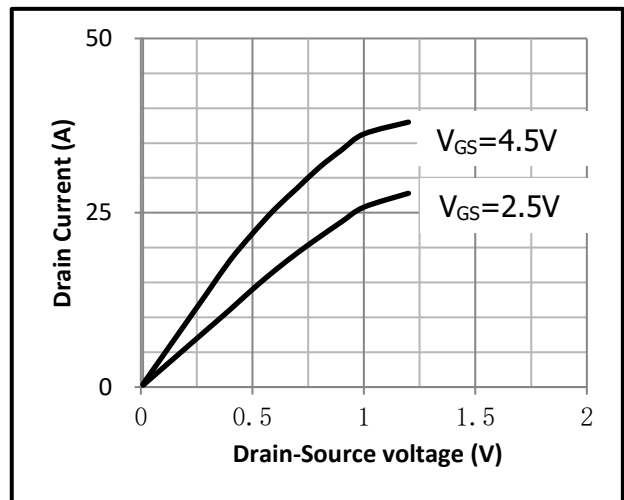

Fig.5 Threshold Voltage V.S Junction Temperature

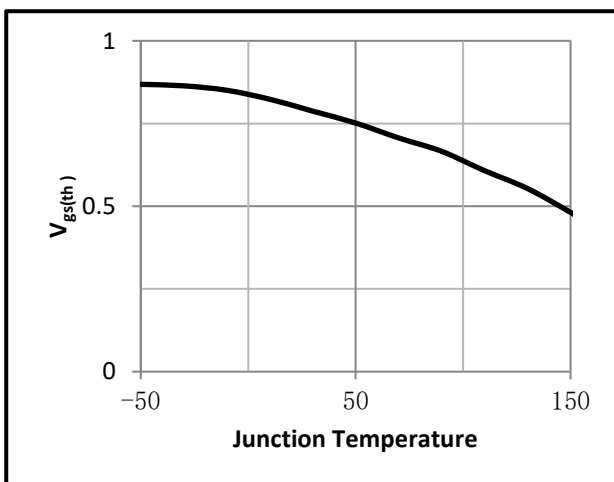

Fig.6 Resistance V.S Drain Current

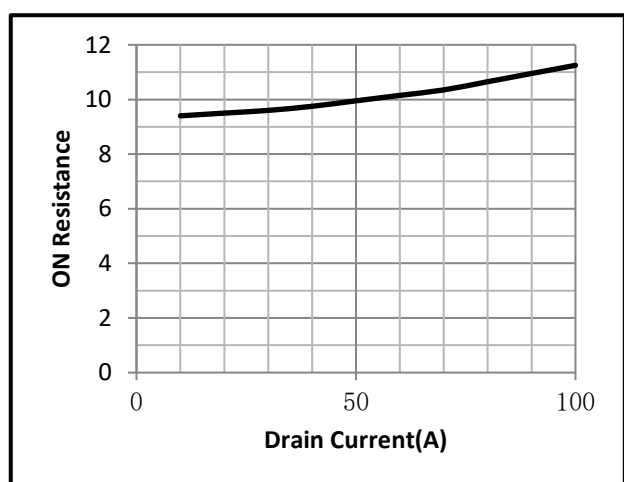

Fig.7 On-Resistance VS Gate Source Voltage

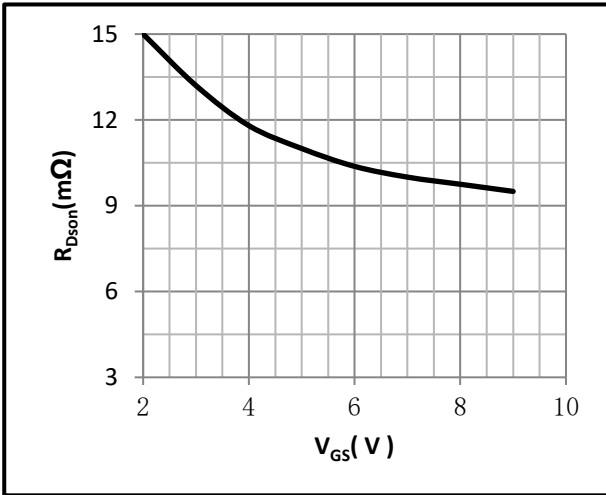

Fig.8 On-Resistance V.S Junction Temperature

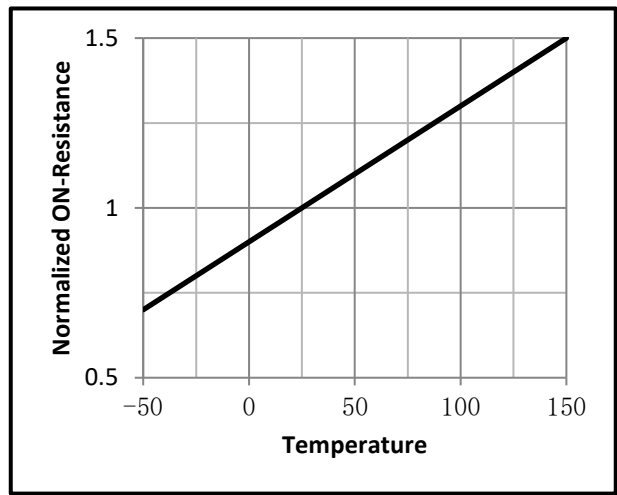

Fig.9 Switching Time Measurement Circuit

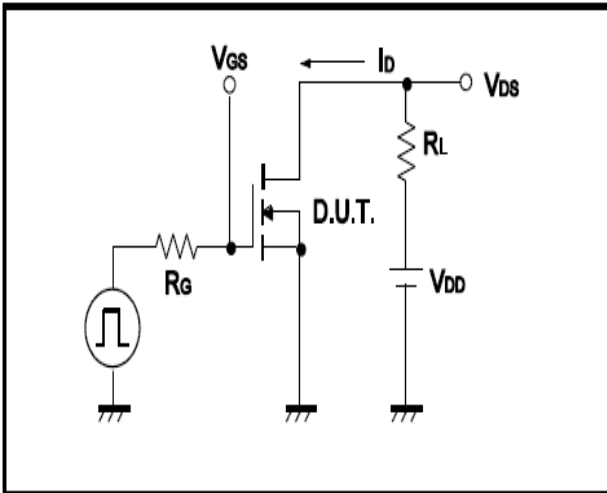

Fig.10 Gate Charge Waveform

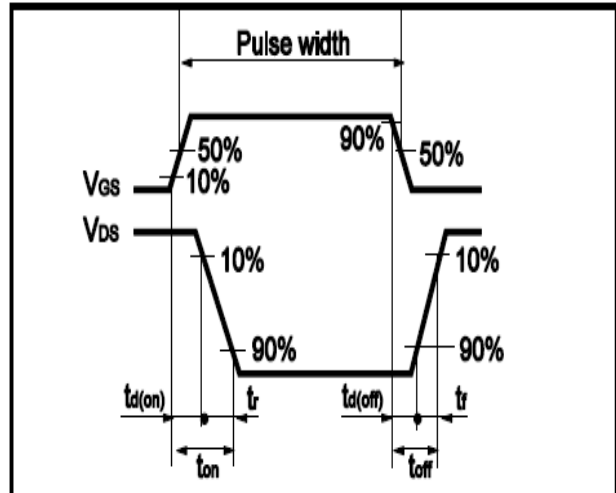

Fig.11 Avalanche Measurement Circuit

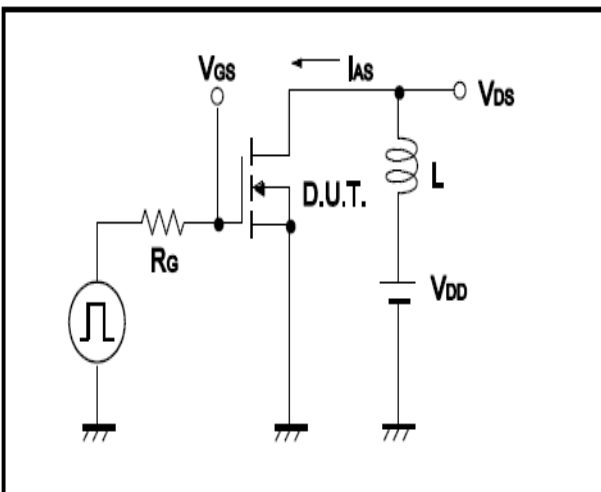
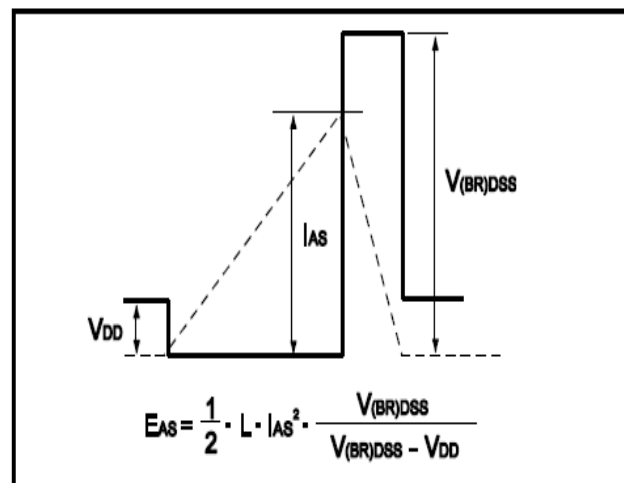

Fig.12 Avalanche Waveform





•Dimensions(SOT23-3)

Unit: mm

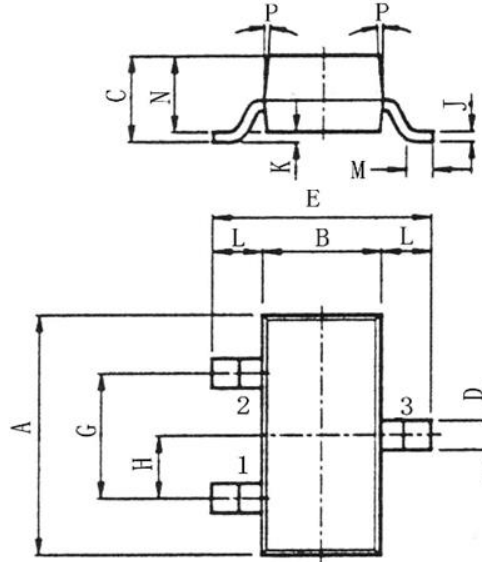

符号 SYMBOL	最小值 min	典型值 nom	最大值 max
A	2.70	2.9	3.10
B	1.15	1.3	1.50
C			1.30
D	0.35	0.4	0.55
E	2.20	2.4	2.70
G	1.70	1.9	2.10
H	0.85	0.95	1.05
J	0.05	0.10	0.20
K	0.00		0.10
L	0.45	0.55	0.65
M	0.20		
N	0.90	1.00	1.20
P		7°	