

**• General Description**

The ZM130P03D combines advanced trench MOSFET technology with a low resistance package to provide extremely low  $R_{DS(ON)}$ .

**• Features**

- Advance high cell density Trench technology
- Low  $R_{DS(ON)}$  to minimize conductive loss
- Low Gate Charge for fast switching
- Low Thermal resistance

**• Application**

- Load Switch
- PWM Application
- BLDC Motor driver

**• Product Summary**

$V_{DS} = -30V$

$R_{DS(ON)} = 13m\Omega$

$I_D = -40A$

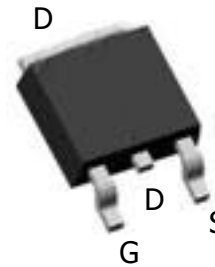
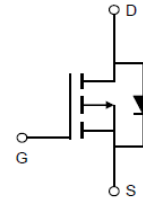

TO-252

**• Ordering Information:**

Part NO.	ZM130P03D
Marking	ZM130P03
Packing Information	REEL TAPE
Basic ordering unit (pcs)	2500

**• Absolute Maximum Ratings ( $T_c = 25^\circ C$ )**

Parameter	Symbol	Rating	Unit
Drain-Source Voltage	$V_{DS}$	-30	V
Gate-Source Voltage	$V_{GS}$	$\pm 20$	V
Continuous Drain Current	$I_{D@TC=25^\circ C}$	-40	A
	$I_{D@TC=75^\circ C}$	-30.4	A
	$I_{D@TC=100^\circ C}$	-25.2	A
Pulsed Drain Current <sup>①</sup>	$I_{DM}$	-100	A
Total Power Dissipation <sup>②</sup>	$P_D@TC=25^\circ C$	70	W
Total Power Dissipation	$P_D@TA=25^\circ C$	2.8	W
Operating Junction Temperature	$T_J$	-55 to 150	$^\circ C$
Storage Temperature	$T_{STG}$	-55 to 150	$^\circ C$
Single Pulse Avalanche Energy@L=0.1mH	$E_{AS}$	80	mJ
Avalanche Current@L=0.1mH	$I_{AS}$	-30	A

**•Thermal resistance**

Parameter	Symbol	Min.	Typ.	Max.	Unit
Thermal resistance, junction - case <sup>②</sup>	R <sub>thJC</sub>	-	-	1.8	° C/W
Thermal resistance, junction - ambient	R <sub>thJA</sub>	-	-	45	° C/W
Soldering temperature, wavesoldering for 10s	T <sub>sold</sub>	-	-	265	° C

**•Electronic Characteristics**

Parameter	Symbol	Condition	Min.	Typ	Max.	Unit
Drain-Source Breakdown Voltage	BV <sub>DSS</sub>	V <sub>GS</sub> =0V, I <sub>D</sub> =-250uA	-30			V
Gate Threshold Voltage	V <sub>GS(TH)</sub>	V <sub>GS</sub> =V <sub>DS</sub> , I <sub>D</sub> =-250uA	-1.2		-2.5	V
Drain-Source Leakage Current	I <sub>DSS</sub>	V <sub>DS</sub> =-30V, V <sub>GS</sub> =0V			-1.0	uA
Gate- Source Leakage Current	I <sub>GSS</sub>	V <sub>GS</sub> =±20V, V <sub>DS</sub> =0V			±100	nA
Static Drain-source On Resistance	R <sub>DS(ON)</sub>	V <sub>GS</sub> =-10V, I <sub>D</sub> =-9A		13	17	mΩ
		V <sub>GS</sub> =-4.5V, I <sub>D</sub> =-8A		22	25	mΩ
Forward Transconductance	g <sub>FS</sub>	V <sub>DS</sub> =-10V, I <sub>D</sub> =-5A		9		s
Source-drain voltage	V <sub>SD</sub>	I <sub>S</sub> =-9A			1.28	V

**•Electronic Characteristics**

Parameter	Symbol	Condition	Min.	Typ	Max.	Unit
Input capacitance	C <sub>iss</sub>	V <sub>GS</sub> =0V, V <sub>DS</sub> =-15V f = 1MHz	-	1650	-	pF
Output capacitance	C <sub>oss</sub>		-	330	-	
Reverse transfer capacitance	C <sub>rss</sub>		-	220	-	

**•Gate Charge characteristics(T<sub>a</sub> = 25°C)**

Parameter	Symbol	Condition	Min.	Typ	Max.	Unit
Total gate charge	Q <sub>g</sub>	V <sub>DD</sub> =-20V	-	18	-	nC
Gate - Source charge	Q <sub>gs</sub>	I <sub>D</sub> = -12A	-	6	-	
Gate - Drain charge	Q <sub>gd</sub>	V <sub>GS</sub> = -10V	-	7	-	

Note: ① Pulse Test : Pulse width ≤ 300μs, Duty cycle ≤ 2% ;

② Device mounted on FR-4 substrate PC board, 2oz copper, with thermal bias to bottom layer 1inch square copper plate;

Fig.1 Gate-Charge Characteristics

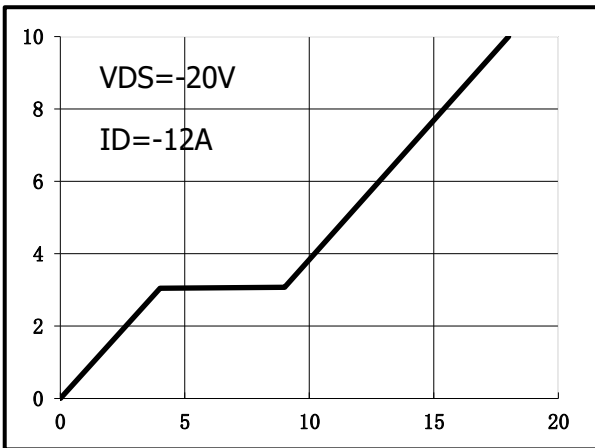

Fig.2 Capacitance Characteristics

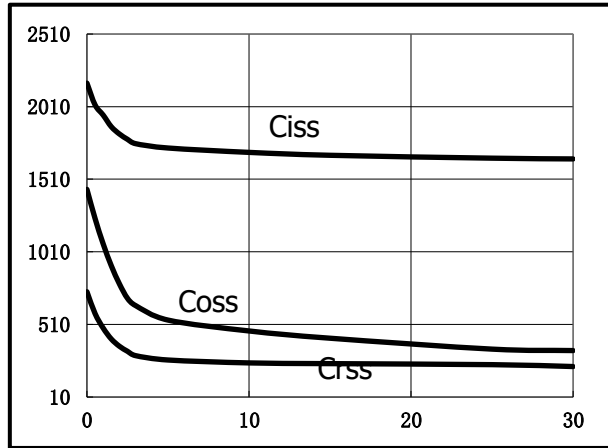

Fig.3 Power Dissipation Derating Curve

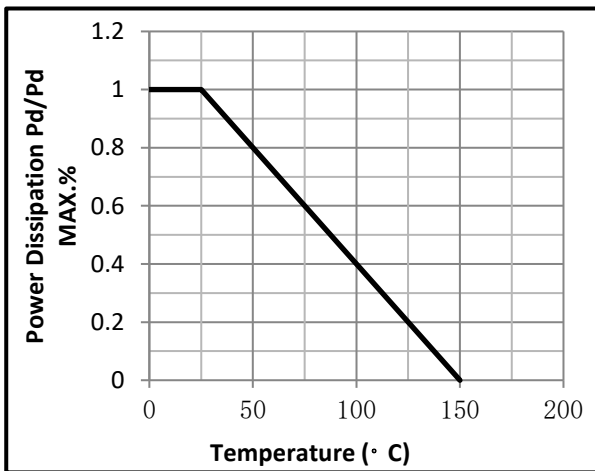

Fig.4 Typical output Characteristics

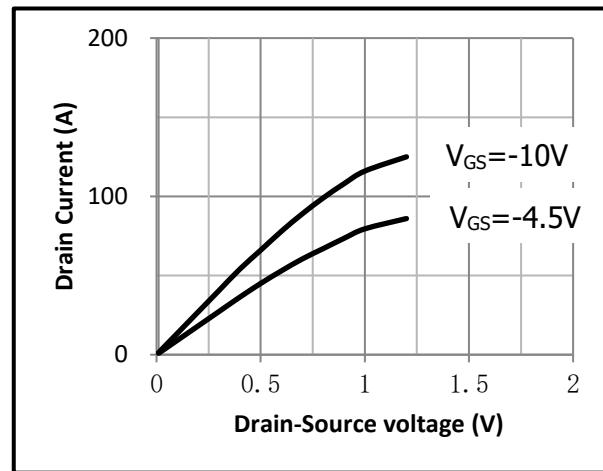

Fig.5 Threshold Voltage V.S Junction Temperature

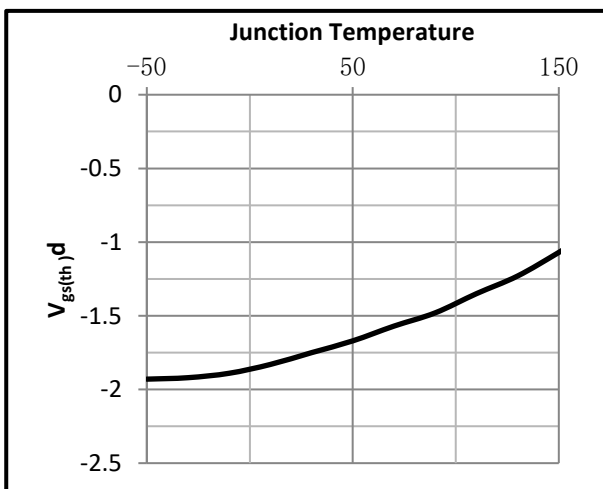

Fig.6 Resistance V.S Drain Current

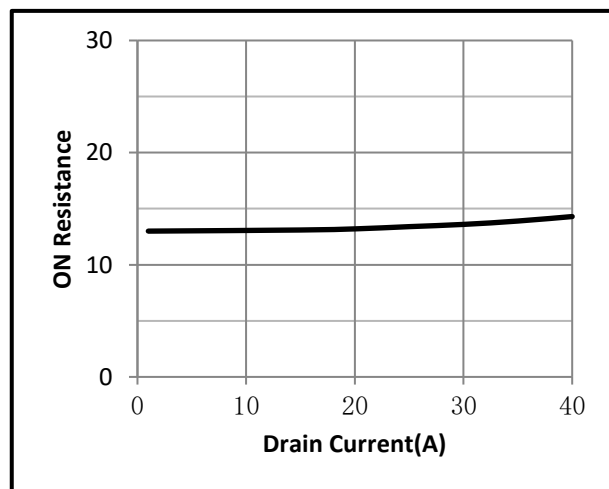

Fig.7 On-Resistance VS Gate Source Voltage

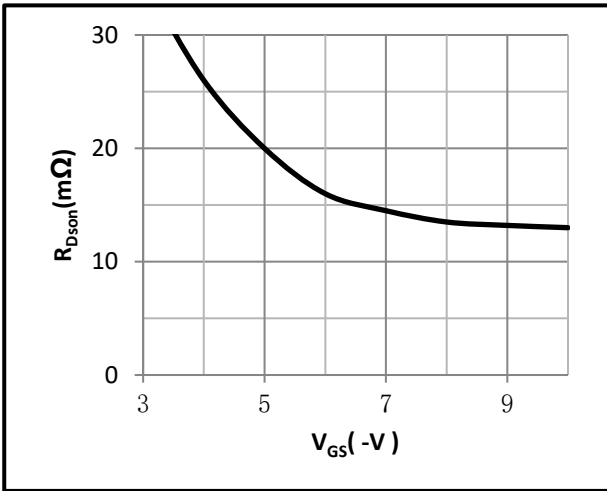

Fig.8 On-Resistance V.S Junction Temperature

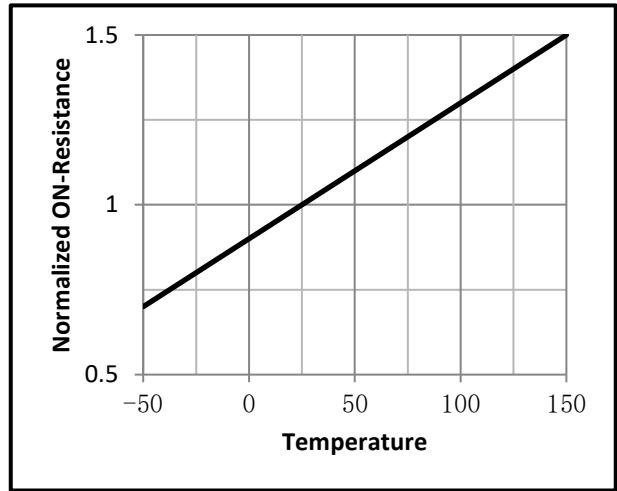

Fig.9 Switching Time Measurement Circuit

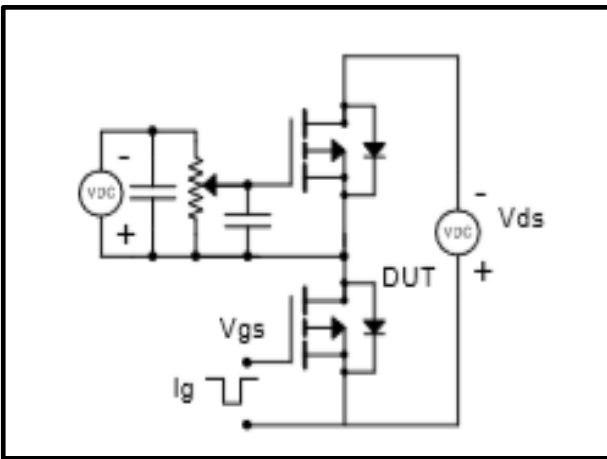

Fig.10 Gate Charge Waveform

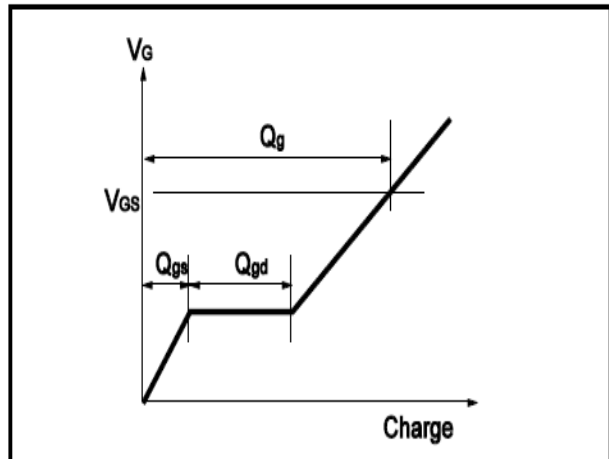

Fig.11 Switching Time Measurement Circuit

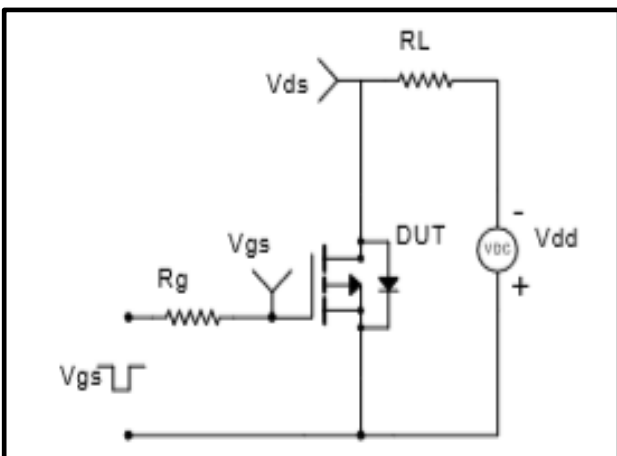
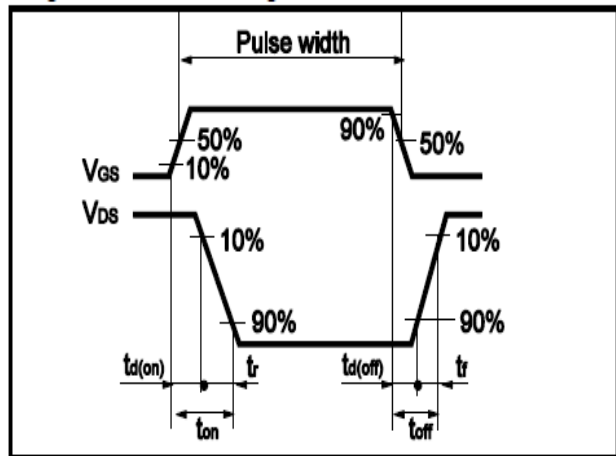

Fig.12 Gate Charge Waveform



•Dimensions(TO-252)

Unit: mm

SYMBOL	min	max	SYMBOL	min	max
A	2.10	2.50	B	0.85	1.25
b	0.50	0.80	b1	0.50	0.90
b2	0.45	0.70	C	0.45	0.70
D	6.30	6.75	D1	5.10	5.50
E	5.30	6.30	e1	2.25	2.35
L1	9.20	10.60	e2	4.45	4.75
L2	0.90	1.75	L3	0.60	1.10
K	0.00	0.23			

