

• General Description

The ZM105N08S combines advanced trench MOSFET technology with a low resistance package to provide extremely low $R_{DS(ON)}$.

• Features

- Advance high cell density Trench technology
- Low $R_{DS(ON)}$ to minimize conductive loss
- Low Gate Charge for fast switching
- Low Thermal resistance

• Application

- Synchronous Rectification in DC/DC and AC/DC Converters
- Industrial and Motor Drive applications

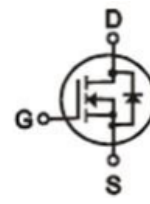
• Product Summary

$V_{DS}=80V$

$R_{DS(ON)} = 10.5m\Omega$

$I_D=11A$

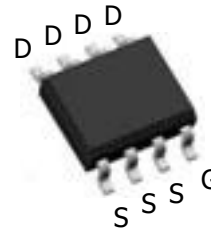
SOP-8
• Ordering Information:

Part NO.	ZM105N08S
Marking	ZM105N08
Packing Information	REEL TAPE
Basic ordering unit (pcs)	4000

• Absolute Maximum Ratings ($T_C = 25^\circ C$)

Parameter	Symbol	Rating	Unit
Drain-Source Voltage	V_{DS}	80	V
Gate-Source Voltage	V_{GS}	± 20	V
Continuous Drain Current ^②	$I_D@TC=25^\circ C$	11	A
	$I_D@TC=75^\circ C$	8.4	A
	$I_D@TC=100^\circ C$	6.9	A
Pulsed Drain Current ^①	I_{DM}	33	A
Total Power Dissipation ^②	$P_D@TC=25^\circ C$	3.6	W
Total Power Dissipation	$P_D@TA=25^\circ C$	0.69	W
Operating Junction Temperature	T_J	-55 to 150	$^\circ C$
Storage Temperature	T_{STG}	-55 to 150	$^\circ C$
Single Pulse Avalanche Energy@L=0.1mH	E_{AS}	80	mJ

**•Thermal resistance**

Parameter	Symbol	Min.	Typ.	Max.	Unit
Thermal resistance, junction - case ^②	R _{thJC}	-	-	34	° C/W
Thermal resistance, junction - ambient	R _{thJA}	-	-	180	° C/W
Soldering temperature, wavesoldering for 10s	T _{sold}	-	-	265	° C

•Electronic Characteristics

Parameter	Symbol	Condition	Min.	Typ	Max.	Unit
Drain-Source Breakdown Voltage	BV _{DSS}	V _{GS} =0V, I _D =250uA	80			V
Gate Threshold Voltage	V _{GS(TH)}	V _{GS} =V _{DS} , I _D =250uA	1.2		2.5	V
Drain-Source Leakage Current	I _{DSS}	V _{DS} =80V, V _{GS} =0V			1.0	uA
Gate- Source Leakage Current	I _{GSS}	V _{GS} =±20V ,V _{DS} =0V			±100	nA
Static Drain-source On Resistance	R _{DS(ON)}	V _{GS} =10V, I _D =10A		10.5	13.5	mΩ
		V _{GS} =4.5V, I _D =8A		13	17	mΩ
Forward Transconductance	g _{FS}	V _{DS} =25V, I _D =4A		24		s
Source-drain voltage	V _{SD}	I _S =10A			1.28	V

•Electronic Characteristics

Parameter	Symbol	Condition	Min.	Typ	Max.	Unit
Input capacitance	C _{iss}	f = 1MHz	-	5300	-	pF
Output capacitance	C _{oss}		-	450	-	
Reverse transfer capacitance	C _{rss}		-	280	-	

•Gate Charge characteristics(T_a=25°C)

Parameter	Symbol	Condition	Min.	Typ	Max.	Unit
Total gate charge	Q _g	V _{DD} =30V	-	72	-	nC
Gate - Source charge	Q _{gs}	I _D = 6A	-	18	-	
Gate - Drain charge	Q _{gd}	V _{GS} = 10V	-	21	-	

Note: ① Pulse Test : Pulse width ≤ 300μs, Duty cycle ≤ 2% ;

② Device mounted on FR-4 substrate PC board, 2oz copper, with thermal bias to bottom layer 1inch square copper plate;

Fig.1 Gate-Charge Characteristics

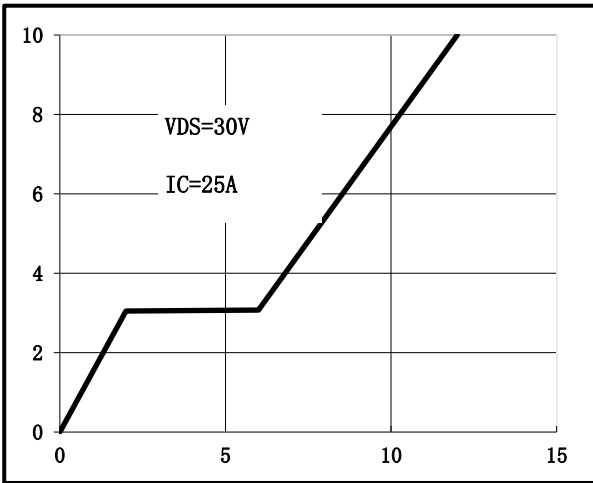

Fig.2 Capacitance Characteristics

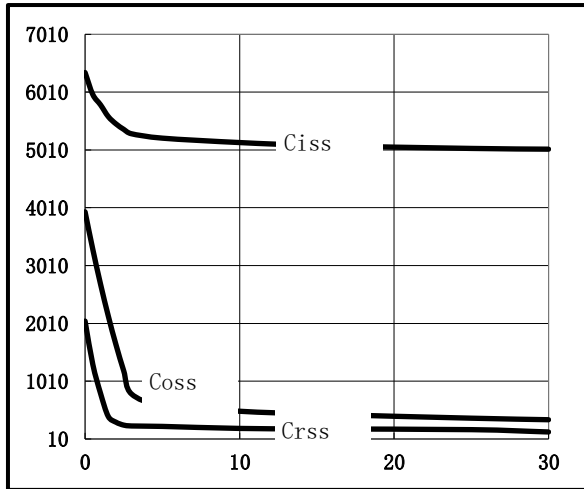

Fig.3 Power Dissipation

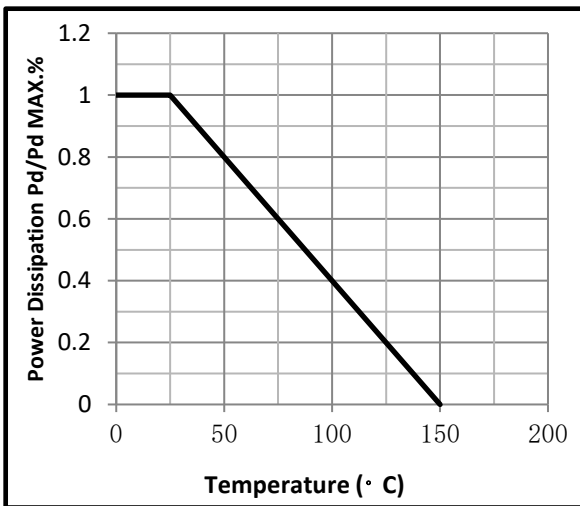

Fig.4 Typical output Characteristics

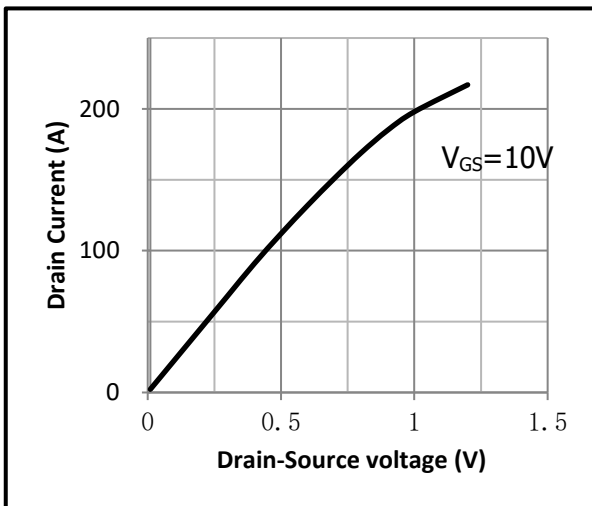

Fig.5 Threshold Voltage V.S Junction Temperature

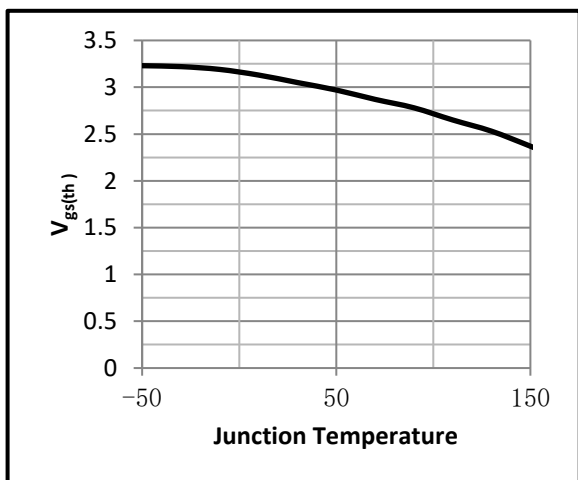

Fig.6 Resistance V.S Drain Current

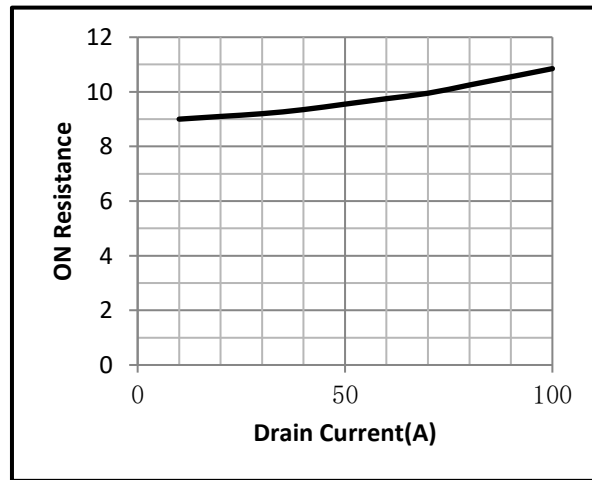

Fig.7 On-Resistance VS Gate Source Voltage

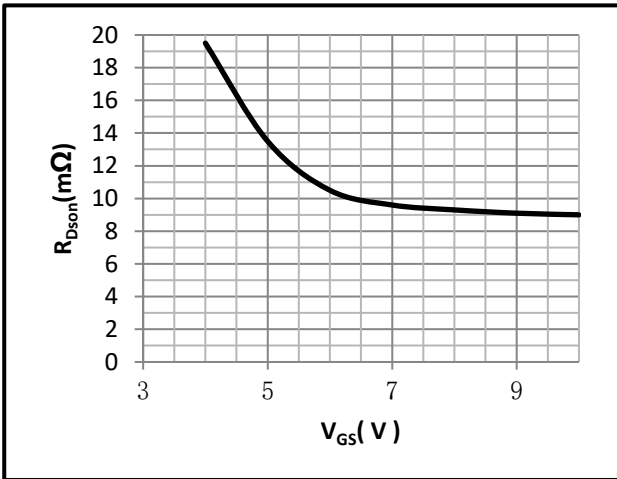

Fig.8 On-Resistance V.S Junction Temperature

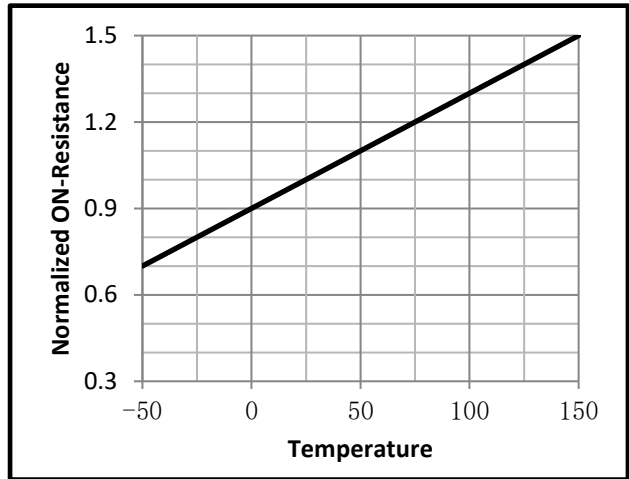

Fig.9 Switching Time Measurement Circuit

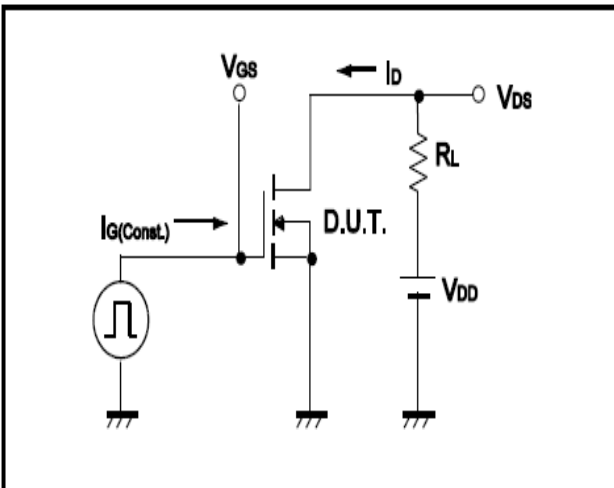

Fig.10 Gate Charge Waveform

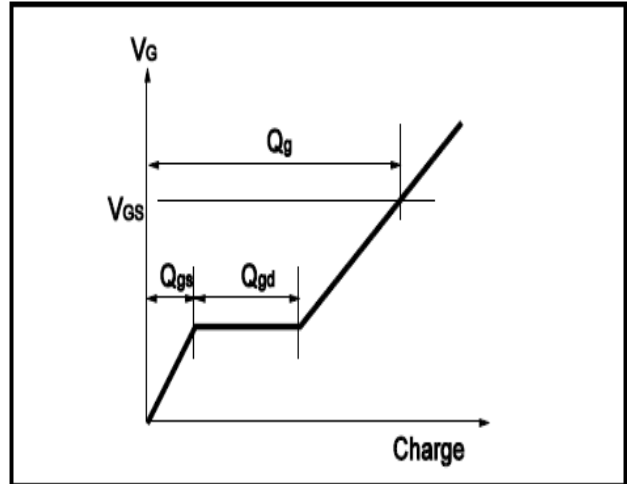

Fig.11 Switching Time Measurement Circuit

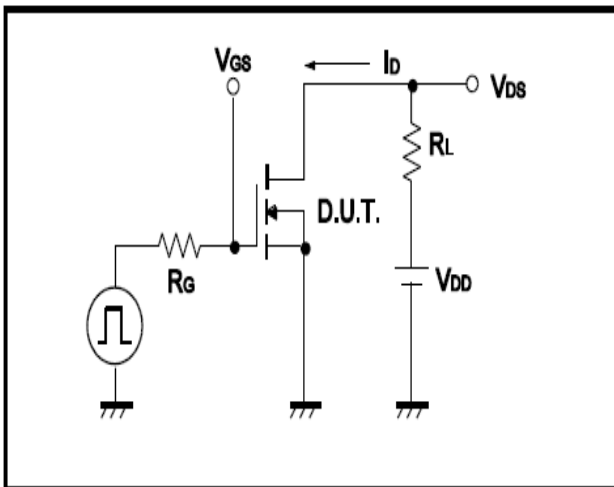
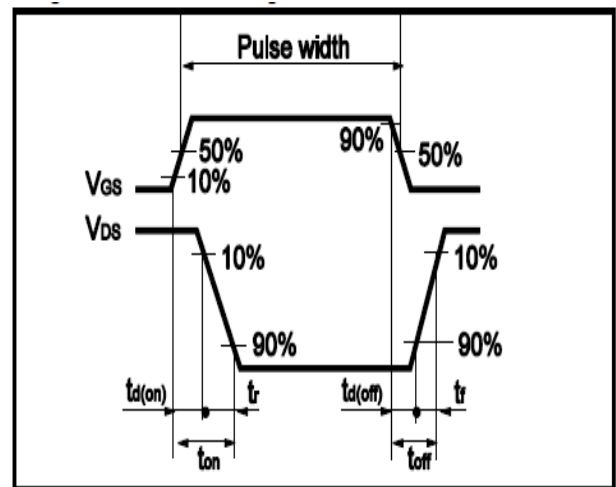

Fig.12 Gate Charge Waveform



•Dimensions(SOP8)

Unit: mm

SYMBOL	min	TYP	max	SYMBOL	min		max
A	4.80		5.00	C	1.30		1.50
A1	0.37		0.47	C1	0.55		0.75
A2		1.27		C2	0.55		0.65
A3		0.41		C3	0.05		0.20
B	5.80		6.20	C4	0.19	0.20	0.23
B1	3.80		4.00	D		1.05	
B2		5.00		D1	0.40		0.62

