

• General Description

The ZM300P04T combines advanced trench MOSFET technology with a low resistance package to provide extremely low $R_{DS(ON)}$.

• Features

- Advance high cell density Trench technology
- Low $R_{DS(ON)}$ to minimize conductive loss
- Low Gate Charge for fast switching
- Low Thermal resistance

• Application

- Load Switches
- DC/DC
- BLDC Motor driver

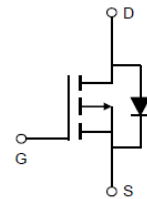
• Product Summary

$$V_{DS} = -40V$$

$$R_{DS(ON)} = 30m\Omega$$

$$I_D = -5.6A$$

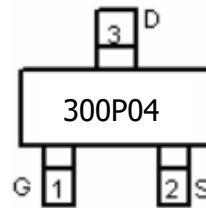

SOT23-3

• Ordering Information:

Part NO.	ZM300P04T
Marking	300P04
Packing Information	REEL TAPE
Basic ordering unit (pcs)	3000

• Absolute Maximum Ratings ($T_c = 25^\circ C$)

Parameter	Symbol	Rating	Unit
Drain-Source Voltage	V_{DS}	-40	V
Gate-Source Voltage	V_{GS}	± 20	V
Continuous Drain Current	$I_{D@TC=25^\circ C}$	-5.8	A
	$I_{D@TC=75^\circ C}$	-4.4	A
	$I_{D@TC=100^\circ C}$	-3.7	A
Pulsed Drain Current ^①	I_{DM}	-12	A
Total Power Dissipation ^②	P_D	1.5	W
Total Power Dissipation ($T_A = 25^\circ C$)	$P_{D@TA=25^\circ C}$	0.7	W
Operating Junction Temperature	T_J	-55 to 150	$^\circ C$
Storage Temperature	T_{STG}	-55 to 150	$^\circ C$
Single Pulse Avalanche Energy	E_{AS}	60	mJ

•Thermal resistance

Parameter	Symbol	Min.	Typ.	Max.	Unit
Thermal resistance, junction - case ^②	R _{thJC}	-	-	80	° C/W
Thermal resistance, junction - ambient	R _{thJA}	-	-	180	° C/W
Soldering temperature, wavesoldering for 10s	T _{sold}	-	-	265	° C

•Electronic Characteristics

Parameter	Symbol	Condition	Min.	Typ	Max.	Unit
Drain-Source Breakdown Voltage	BV _{DSS}	V _{GS} =0V, I _D =-250uA	-40			V
Gate Threshold Voltage	V _{GS(TH)}	V _{GS} =V _{DS} , I _D =-250uA	-1.2		-2.5	V
Drain-Source Leakage Current	I _{DSS}	V _{DS} =-40V, V _{GS} =0V			1.0	uA
Gate- Source Leakage Current	I _{GSS}	V _{GS} =±20V, V _{DS} =0V			±100	nA
Static Drain-source On Resistance	R _{DS(ON)}	V _{GS} =-10V, I _D =-5.6A		30	35	mΩ
		V _{GS} =-4.5V, I _D =-4A		42	50	mΩ
Forward Transconductance	g _{FS}	V _{DS} =-10V, I _D =-2A		10		s
Source-drain voltage	V _{SD}	I _S =-5.6A			1.28	V

•Electronic Characteristics

Parameter	Symbol	Condition	Min.	Typ	Max.	Unit
Input capacitance	C _{iss}	f = 1MHz	-	1650	-	pF
Output capacitance	C _{oss}		-	330	-	
Reverse transfer capacitance	C _{rss}		-	220	-	

•Gate Charge characteristics(T_a = 25°C)

Parameter	Symbol	Condition	Min.	Typ	Max.	Unit
Total gate charge	Q _g	V _{DD} =-20V	-	31	-	nC
Gate - Source charge	Q _{gs}	I _D =-3A	-	8	-	
Gate - Drain charge	Q _{gd}	V _{GS} = -10V	-	10	-	

Note: ① Pulse Test : Pulse width ≤ 300μs, Duty cycle ≤ 2% ;

② Device mounted on FR-4 substrate PC board, 2oz copper, with thermal bias to bottom layer 1inch square copper plate;

Fig.1 Gate-Charge Characteristics

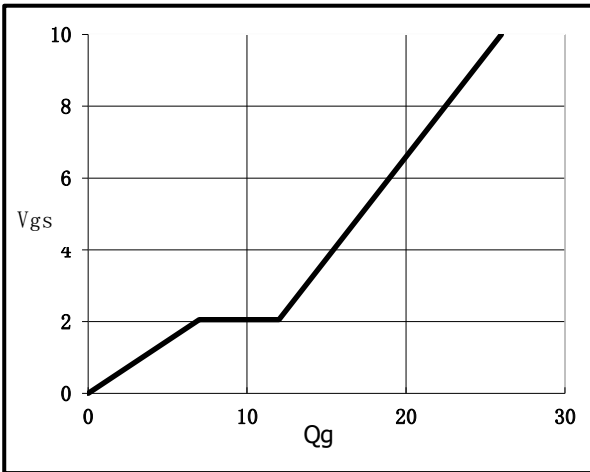

Fig.2 Capacitance Characteristics

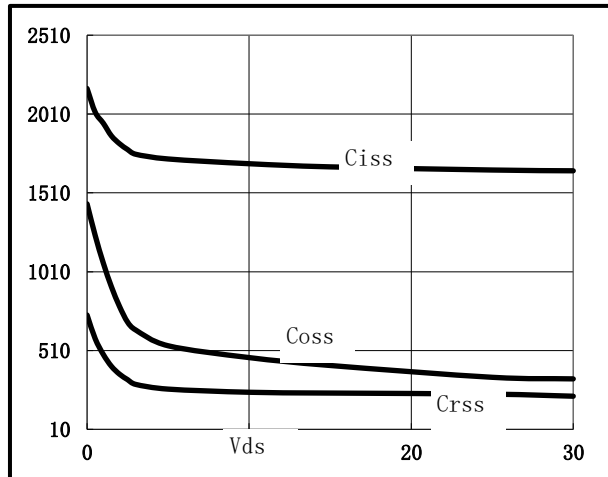

Fig.3 Power Dissipation Derating Curve

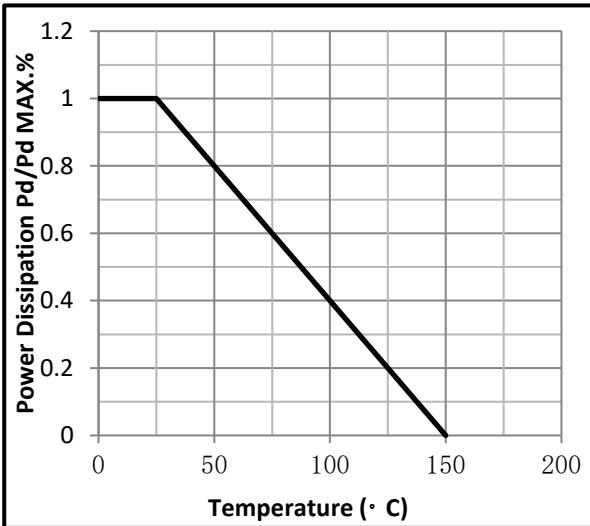

Fig.4 Typical output Characteristics

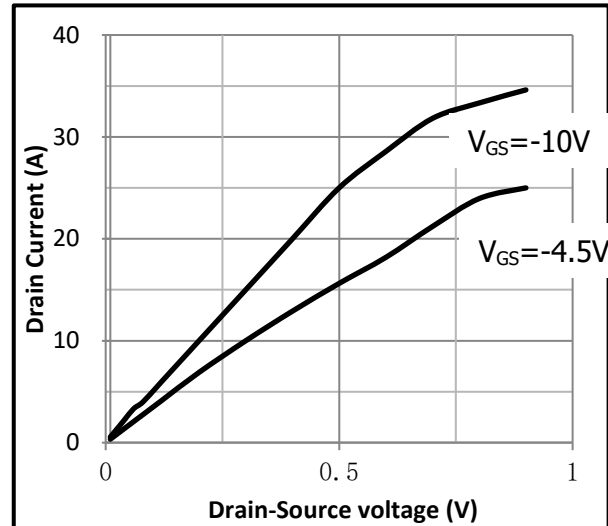

Fig.5 Threshold Voltage V.S Junction Temperature

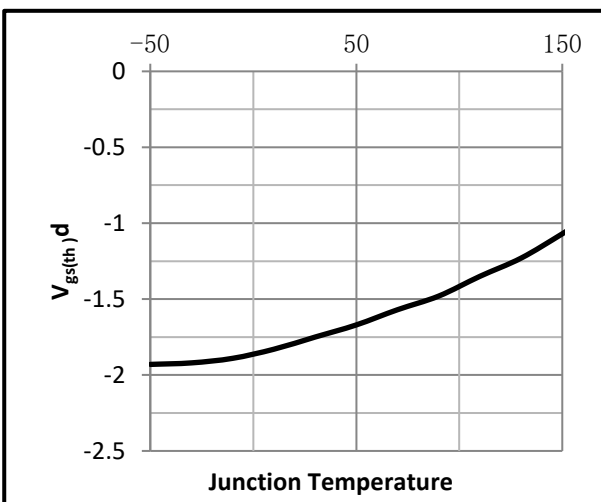

Fig.6 Resistance V.S Drain Current

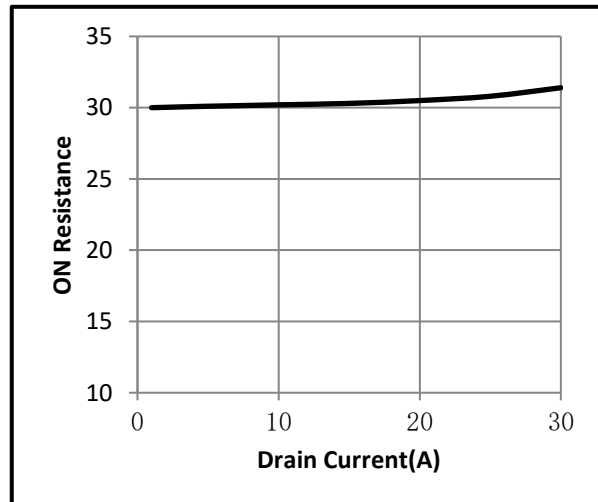

Fig.7 On-Resistance VS Gate Source Voltage

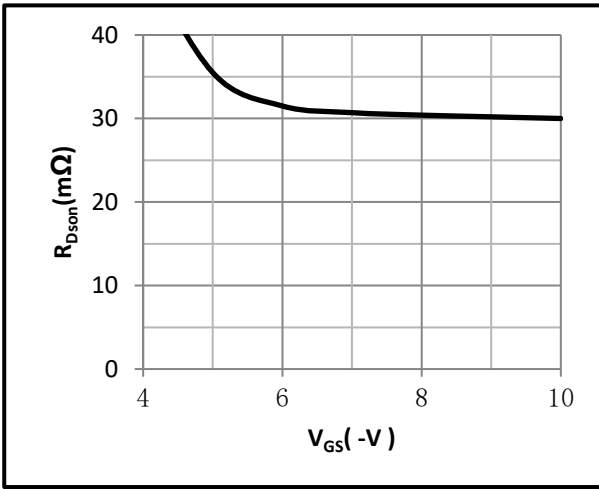

Fig.8 On-Resistance V.S Junction Temperature

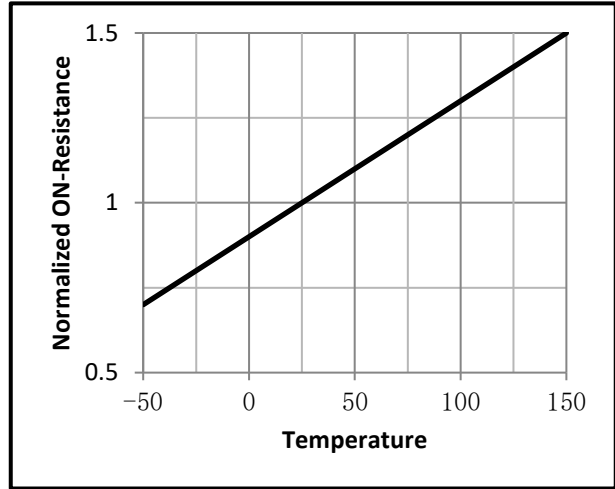

Fig.9 Switching Time Measurement Circuit

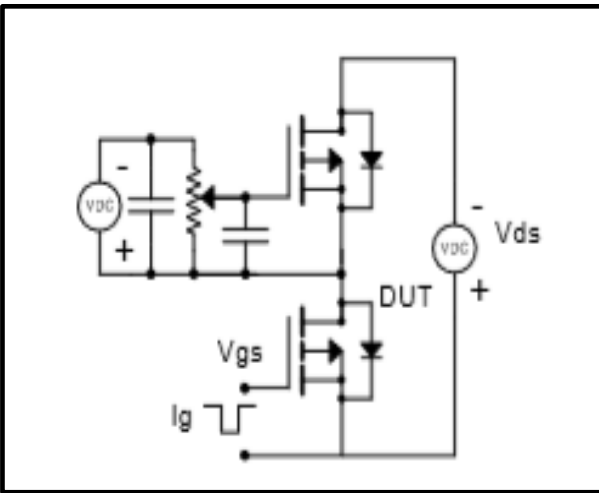

Fig.10 Gate Charge Waveform

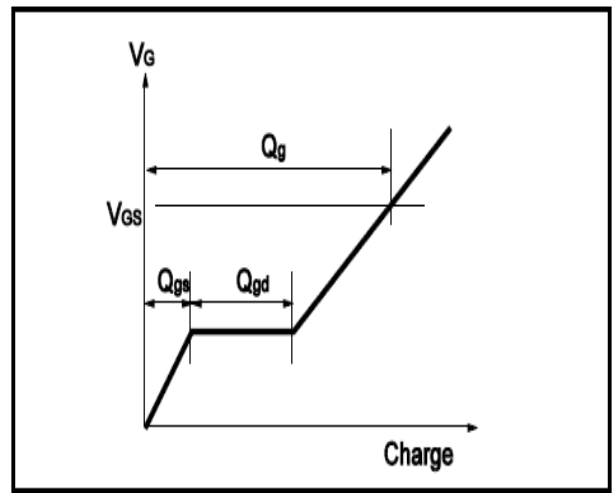

Fig.11 Switching Time Measurement Circuit

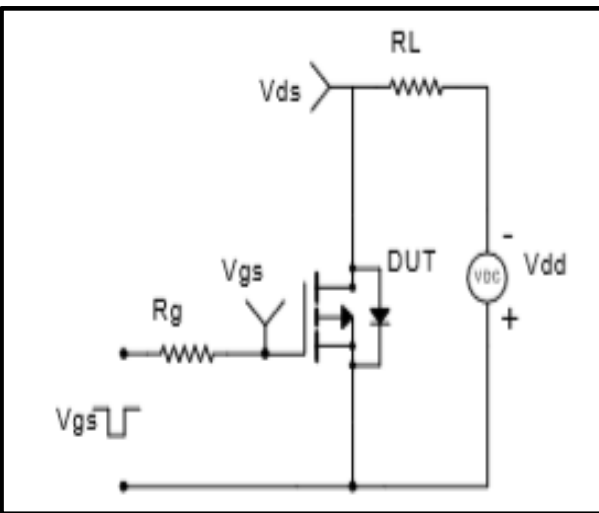
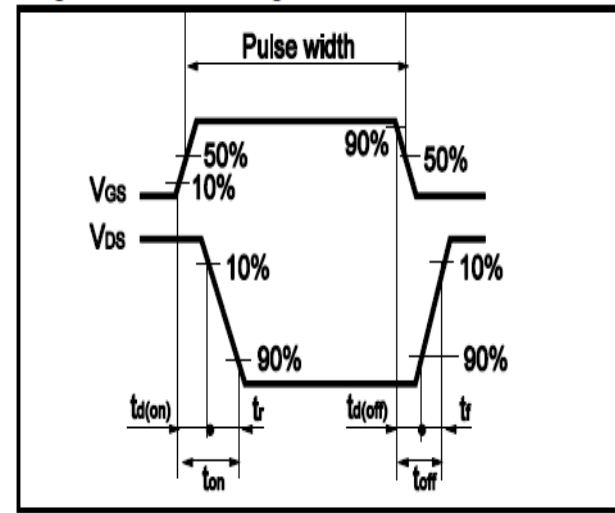

Fig.12 Gate Charge Waveform





•Dimensions(SOT23-3)

Unit: mm

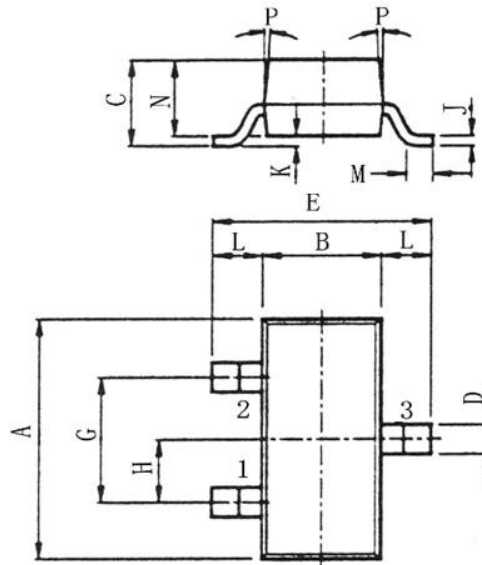

SYMBOL	min	nom	max
A	2.70	2.9	3.10
B	1.15	1.3	1.50
C			1.30
D	0.35	0.4	0.55
E	2.20	2.4	2.70
G	1.70	1.9	2.10
H	0.85	0.95	1.05
J	0.05	0.10	0.20
K	0.00		0.10
L	0.45	0.55	0.65
M	0.20		
N	0.90	1.00	1.20
P		7°	