

• General Description

The ZM350P10D combines advanced trench MOSFET technology with a low resistance package to provide extremely low $R_{DS(ON)}$.

• Features

- Advance high cell density Trench technology
- Low $R_{DS(ON)}$ to minimize conductive loss
- Low Gate Charge for fast switching
- Low Thermal resistance

• Application

- MB/VGA Vcore
- SMPS 2nd Synchronous Rectifier
- POL application
- BLDC Motor driver

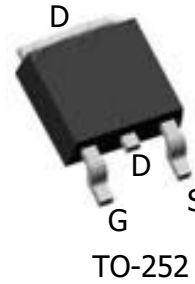
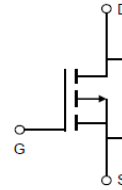
• Product Summary
 $V_{DS} = -100V$
 $R_{DS(ON)} = 40m\Omega$
 $I_D = -30A$

• Ordering Information:

Part NO.	ZM350P10D
Marking	ZM350P10
Packing Information	REEL TAPE
Basic ordering unit (pcs)	2500

• Absolute Maximum Ratings ($T_c = 25^\circ C$)

Parameter	Symbol	Rating	Unit
Drain-Source Voltage	V_{DS}	-100	V
Gate-Source Voltage	V_{GS}	± 20	V
Continuous Drain Current	$I_D @ TC=25^\circ C$	-30	A
	$I_D @ TC=75^\circ C$	-23	A
	$I_D @ TC=100^\circ C$	-19	A
Pulsed Drain Current ^①	I_{DM}	-90	A
Total Power Dissipation($TC=25^\circ C$)	$P_D @ TC=25^\circ C$	55	W
Total Power Dissipation($TA=25^\circ C$)	$P_D @ TA=25^\circ C$	2.5	W
Operating Junction Temperature	T_J	-55 to 150	$^\circ C$
Storage Temperature	T_{STG}	-55 to 150	$^\circ C$
Single Pulse Avalanche Energy@ $L=0.1mH$	E_{AS}	80	mJ

Avalanche Current@L=0.1mH	I_{AS}	40	A
---------------------------	----------	----	---

•Thermal resistance

Parameter	Symbol	Min.	Typ.	Max.	Unit
Thermal resistance, junction - case	R_{thJC}	-	-	2.1	° C/W
Thermal resistance, junction - ambient	R_{thJA}	-	-	50	° C/W
Soldering temperature, wavesoldering for 10s	T_{sold}	-	-	265	° C

•Electronic Characteristics

Parameter	Symbol	Condition	Min.	Typ	Max.	Unit
Drain-Source Breakdown Voltage	BV_{DSS}	$V_{GS} = 0V, I_D = -250\mu A$	-100			V
Gate Threshold Voltage	$V_{GS(TH)}$	$V_{GS} = V_{DS}, I_D = -250\mu A$	-1.2		-2.5	V
Drain-Source Leakage Current	I_{DSS}	$V_{DS} = -100V, V_{GS} = 0V$			-1.0	μA
Gate- Source Leakage Current	I_{GSS}	$V_{GS} = \pm 20V, V_{DS} = 0V$			± 100	nA
Static Drain-source On Resistance	$R_{DS(ON)}$	$V_{GS} = -10V, I_D = -15A$		40	50	m Ω
		$V_{GS} = -4.5V, I_D = -8A$		42	55	m Ω
Forward Transconductance	g_{FS}	$V_{DS} = -10V, I_D = -10A$		20		s
Source-drain voltage	VSD	$I_S = -15A$			1.28	V

•Electronic Characteristics

Parameter	Symbol	Condition	Min.	Typ	Max.	Unit
Input capacitance	C_{iss}	f = 1MHz	-	4500	-	pF
Output capacitance	C_{oss}		-	398	-	
Reverse transfer capacitance	C_{rss}		-	157	-	

•Gate Charge characteristics($T_a = 25^\circ C$)

Parameter	Symbol	Condition	Min.	Typ	Max.	Unit
Total gate charge	Qg	VDD = -25V	-	124	-	nC
Gate - Source charge	Qgs	ID = -10A	-	20	-	
Gate - Drain charge	Qgd	VGS = -10V	-	29	-	

Note: ① Pulse Test : Pulse width $\leq 300\mu s$, Duty cycle $\leq 2\%$;

② Device mounted on FR-4 substrate PC board, 2oz copper, with thermal bias to bottom layer 1inch square copper plate;

Fig.1 Gate-Charge Characteristics

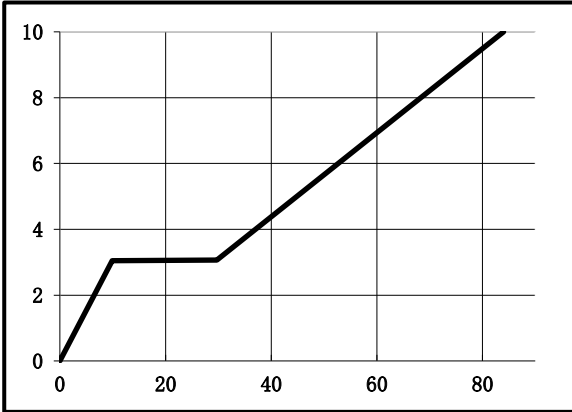

Fig.2 Capacitance Characteristics

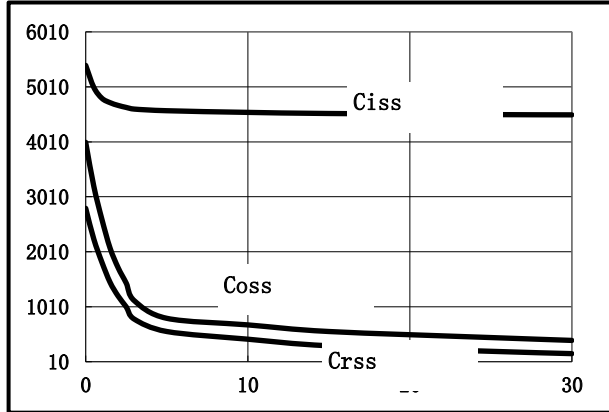

Fig.3 Power Dissipation

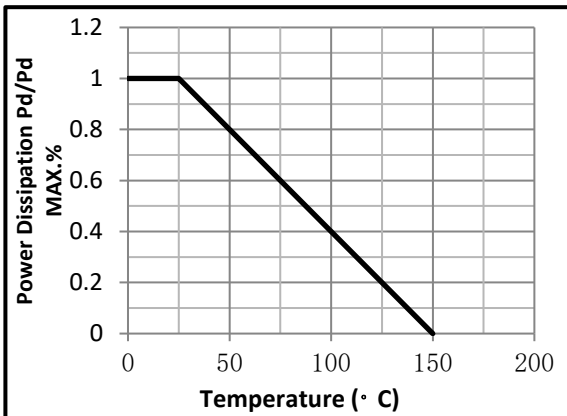

Fig.4 Typical output Characteristics

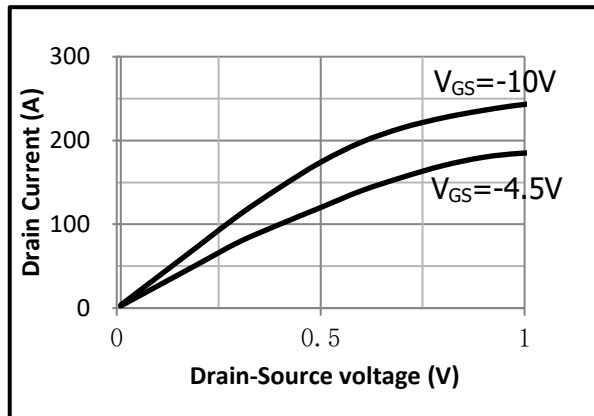

Fig.5 Threshold Voltage V.S Junction Temperature

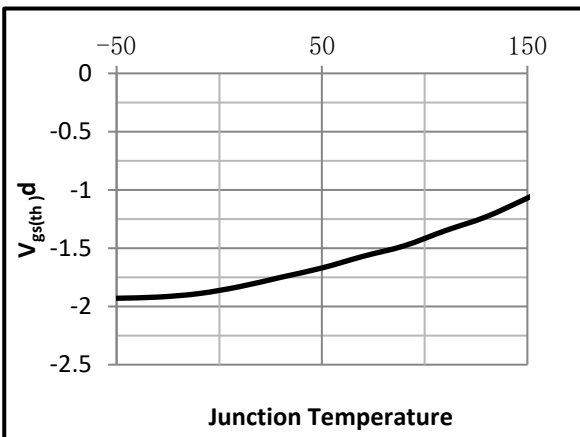

Fig.6 Resistance V.S Drain Current

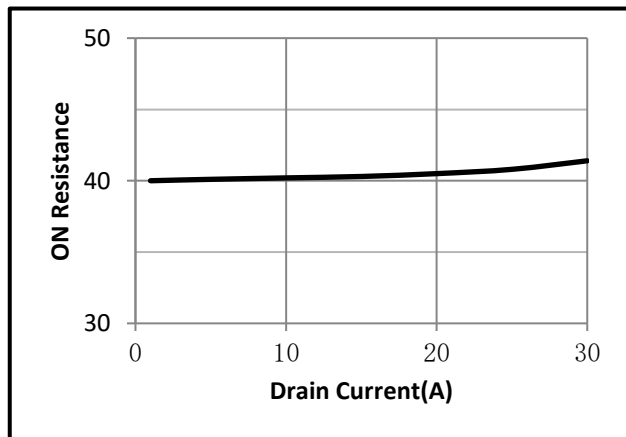

Fig.7 On-Resistance VS Gate Source Voltage

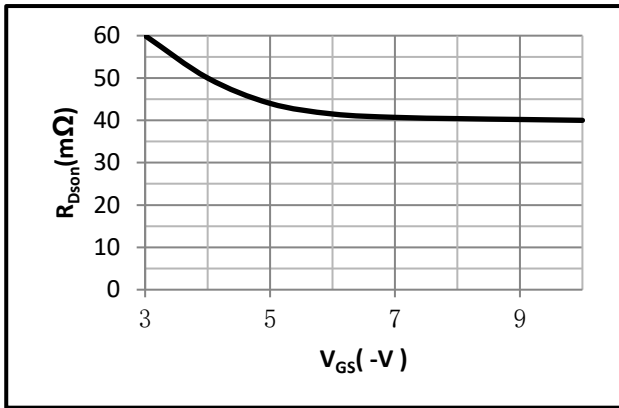

Fig.8 On-Resistance V.S Junction Temperature

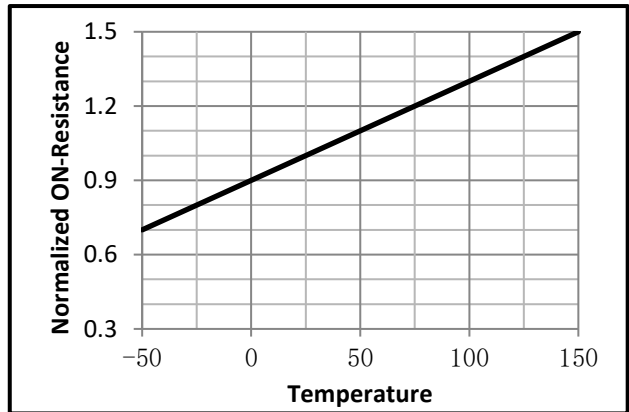

Fig.9 Switching Time Measurement Circuit

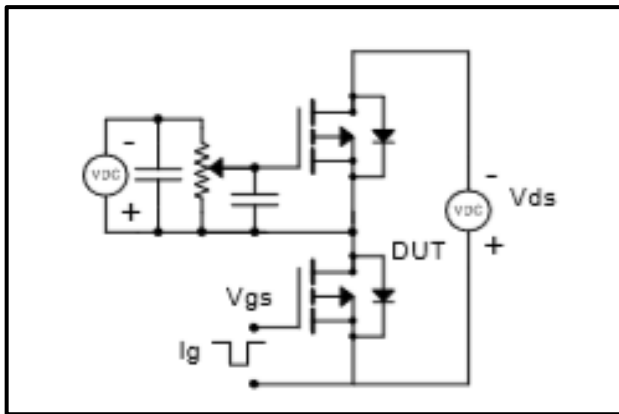

Fig.10 Gate Charge Waveform

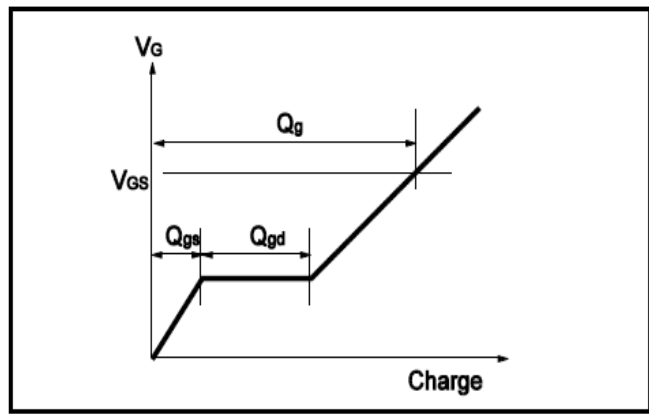

Fig.11 Switching Time Measurement Circuit

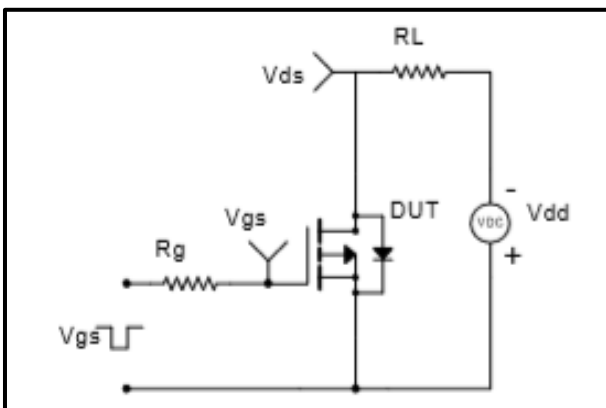
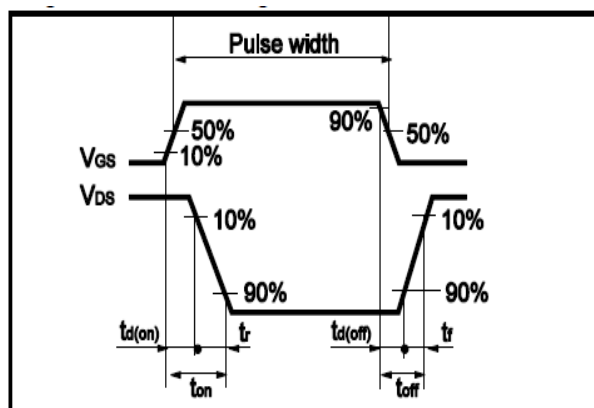

Fig.12 Gate Charge Waveform





• **Dimensions (TO-252)**

Unit: mm

SYMBOL	min	max	SYMBOL	min	max
A	2.10	2.50	B	0.85	1.25
b	0.50	0.80	b1	0.50	0.90
b2	0.45	0.70	C	0.45	0.70
D	6.30	6.75	D1	5.10	5.50
E	5.30	6.30	e1	2.25	2.35
L1	9.20	10.60	e2	4.45	4.75
L2	0.90	1.75	L3	0.60	1.10
K	0.00	0.23			

