

• General Description

The ZMD68302N combines advanced trench MOSFET technology with a low resistance package to provide extremely low $R_{DS(ON)}$.

• Features

- Advance high cell density Trench technology
- Low $R_{DS(ON)}$ to minimize conductive loss
- Low Gate Charge for fast switching
- Dual DIE in one package

• Application

- DC/DC Converters in Computing
- Isolated DC/DC Converters in Telecom and Industrial

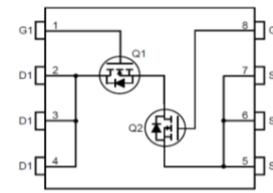
• Product Summary

$V_{DS1} = 30V$
 $V_{DS2} = 30V$
 $R_{DS(ON)1} = 6.6m\Omega$
 $R_{DS(ON)2} = 2.7m\Omega$
 $I_{D1} = 55A$
 $I_{D2} = 95A$

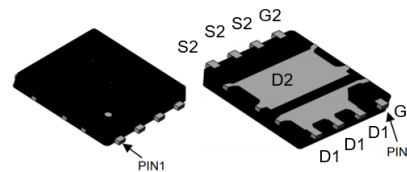
DFN5 x 6
• Ordering Information:

Part NO.	ZMD68302N
Marking	ZMD68302
Packing Information	REEL TAPE
Basic ordering unit (pcs)	3000

• Absolute Maximum Ratings ($T_c = 25^\circ C$) (Q1)

Parameter	Symbol	Rating	Unit
Drain-Source Voltage	V_{DS}	30	V
Gate-Source Voltage	V_{GS}	± 20	V
Continuous Drain Current	$I_D @ TC=25^\circ C$	55	A
	$I_D @ TC=75^\circ C$	41.8	A
	$I_D @ TC=100^\circ C$	34.7	A
Pulsed Drain Current ^①	I_{DM}	120	A
Total Power Dissipation($TC=25^\circ C$)	$P_D @ TC=25^\circ C$	60	W
Total Power Dissipation($TA=25^\circ C$)	$P_D @ TA=25^\circ C$	1.8	W
Operating Junction Temperature	T_J	-55 to 150	$^\circ C$
Storage Temperature	T_{STG}	-55 to 150	$^\circ C$
Single Pulse Avalanche Energy@ $L=0.1mH$	E_{AS}	45	mJ
Avalanche Current@ $L=0.1mH$	I_{AS}	30	A

•Thermal resistance(Q1)

Parameter	Symbol	Min.	Typ.	Max.	Unit
Thermal resistance, junction - case	R _{thJC}	-	-	2.1	° C/W
Thermal resistance, junction - ambient	R _{thJA}	-	-	70	° C/W
Soldering temperature, wavesoldering for 10s	T _{sold}	-	-	265	° C

•Electronic Characteristics(Q1)

Parameter	Symbol	Condition	Min.	Typ	Max.	Unit
Drain-Source Breakdown Voltage	BV _{DSS}	V _{GS} =0V, I _D =250uA	30			V
Gate Threshold Voltage	V _{GS(TH)}	V _{GS} =V _{DS} , I _D =250uA	1.2		2.5	V
Drain-Source Leakage Current	I _{DSS}	V _{DS} =30V, V _{GS} =0V			1.0	uA
Gate- Source Leakage Current	I _{GSS}	V _{GS} =±20V, V _{DS} =0V			±100	nA
Static Drain-source On Resistance	R _{DS(ON)}	V _{GS} =10V, I _D =15A		6.6	8.5	mΩ
		V _{GS} =4.5V, I _D =10A		10	13	mΩ
Forward Transconductance	g _{FS}	V _{DS} =25V, I _D =10A		12		s
Source-drain voltage	V _{SD}	I _S =15A			1.28	V

•Electronic Characteristics(Q1)

Parameter	Symbol	Condition	Min.	Typ	Max.	Unit
Input capacitance	C _{iss}	f = 1MHz	-	1150	-	pF
Output capacitance	C _{oss}		-	175	-	
Reverse transfer capacitance	C _{rss}		-	136	-	

•Gate Charge characteristics(T_a = 25°C)(Q1)

Parameter	Symbol	Condition	Min.	Typ	Max.	Unit
Total gate charge	Q _g	V _{DD} = 25V	-	18	-	nC
Gate - Source charge	Q _{gs}	I _D = 5A	-	7	-	
Gate - Drain charge	Q _{gd}	V _{GS} = 10V	-	6	-	

•Absolute Maximum Ratings (T_C =25°C) (Q2)

Parameter	Symbol	Rating	Unit
Drain-Source Voltage	V _{DS}	30	V
Gate-Source Voltage	V _{GS}	±20	V
Continuous Drain Current	I _{D@TC=25°C}	95	A
	I _{D@TC=75°C}	72.2	A
	I _{D@TC=100°C}	59.9	A
Pulsed Drain Current ^①	I _{DM}	230	A
Total Power Dissipation(TC=25°C)	P _{D@TC=25°C}	3.6	W
Total Power Dissipation(TA=25°C)	P _{D@TA=25°C}	0.69	W
Operating Junction Temperature	T _J	-55 to 150	°C
Storage Temperature	T _{STG}	-55 to 150	°C
Single Pulse Avalanche Energy@L=0.1mH	E _{AS}	180	mJ
Avalanche Current@L=0.1mH	I _{AS}	60	A

•Thermal resistance(Q2)

Parameter	Symbol	Min.	Typ.	Max.	Unit
Thermal resistance, junction - case	R _{thJC}	-	-	2.5	° C/W
Thermal resistance, junction - ambient	R _{thJA}	-	-	70	° C/W
Soldering temperature, wavesoldering for 10s	T _{sold}	-	-	265	° C

•Electronic Characteristics(Q2)

Parameter	Symbol	Condition	Min.	Typ	Max.	Unit
Drain-Source Breakdown Voltage	BV _{DSS}	V _{GS} =0V, I _D =250uA	30			V
Gate Threshold Voltage	V _{GS(TH)}	V _{GS} =V _{DS} , I _D =250uA	1.2		2.5	V
Drain-Source Leakage Current	I _{DSS}	V _{DS} =30V, V _{GS} =0V			1.0	uA
Gate- Source Leakage Current	I _{GSS}	V _{GS} =±20V, V _{DS} =0V			±100	nA
Static Drain-source On Resistance	R _{DS(ON)}	V _{GS} =10V, I _D =20A		2.7	3.6	mΩ
		V _{GS} =4.5V, I _D =10A		4.5	5.5	mΩ
Forward Transconductance	g _{FS}	V _{DS} =25V, I _D =10A		18		s
Source-drain voltage	V _{SD}	I _S =20A			1.28	V

•Electronic Characteristics(Q2)

Parameter	Symbol	Condition	Min.	Typ	Max.	Unit
Input capacitance	C_{iss}	f = 1MHz	-	2535	-	pF
Output capacitance	C_{oss}		-	196	-	
Reverse transfer capacitance	C_{rss}		-	139	-	

•Gate Charge characteristics($T_a = 25^\circ\text{C}$)(Q2)

Parameter	Symbol	Condition	Min.	Typ	Max.	Unit
Total gate charge	Q_g	$V_{DD} = 25V$	-	29	-	nC
Gate - Source charge	Q_{gs}	$I_D = 5A$	-	12	-	
Gate - Drain charge	Q_{gd}	$V_{GS} = 10V$	-	11	-	

Note: ① Pulse Test : Pulse width $\leq 300\mu\text{s}$, Duty cycle $\leq 2\%$;

• Channel characteristics curve(Q1)

Fig.1 Gate-Charge Characteristics

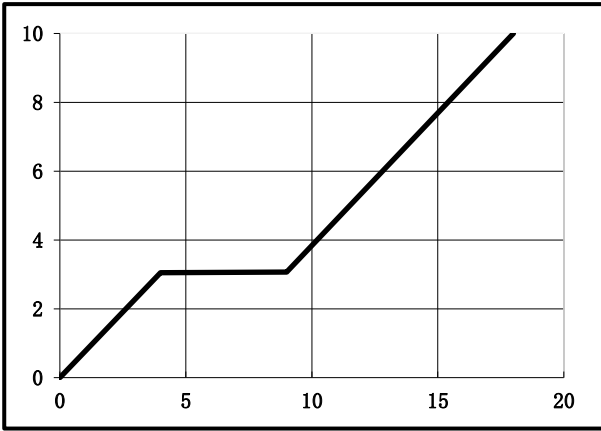

Fig.2 Capacitance Characteristics

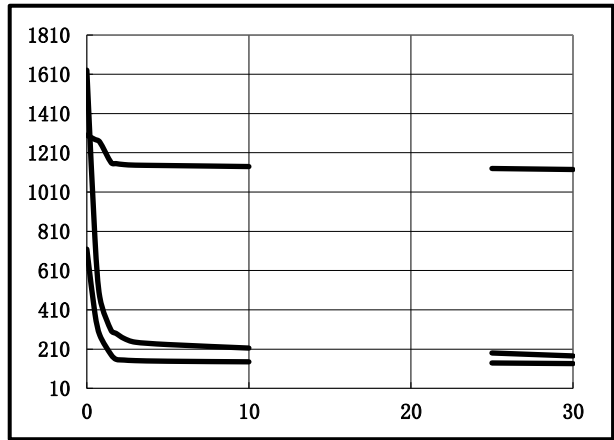

Fig.3 Power Dissipation

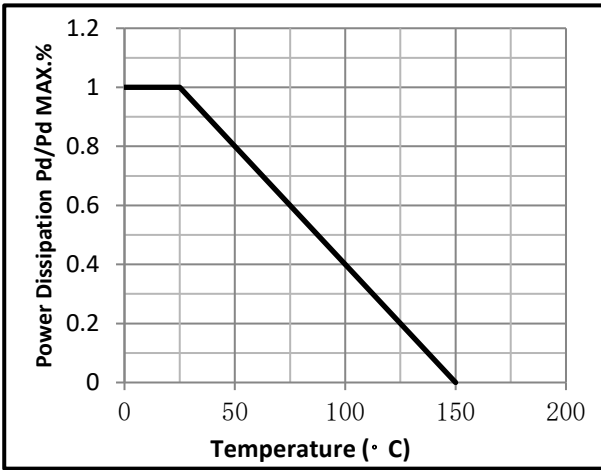

Fig.4 Typical output Characteristics

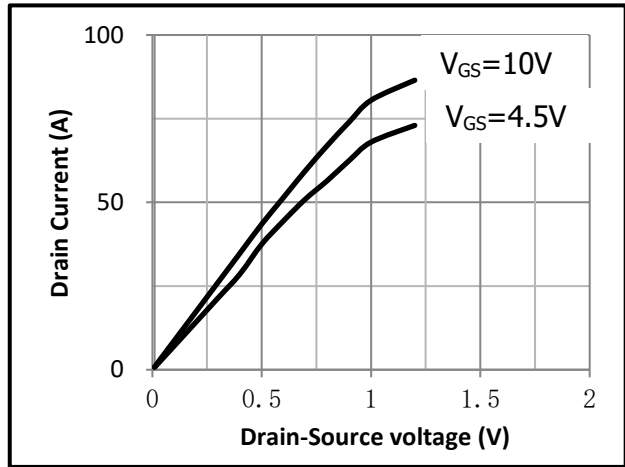

Fig.5 Threshold Voltage V.S Junction Temperature

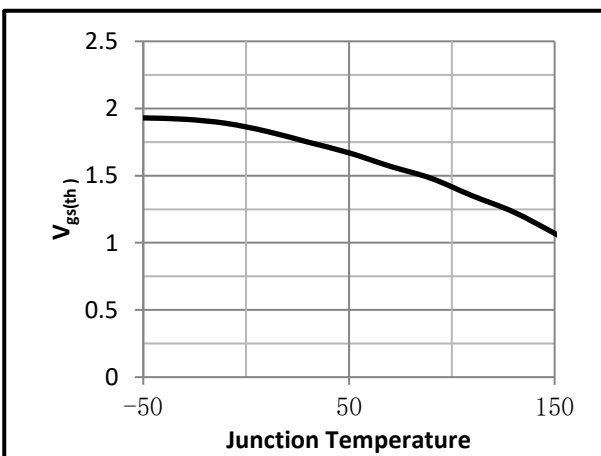

Fig.6 Resistance V.S Drain Current

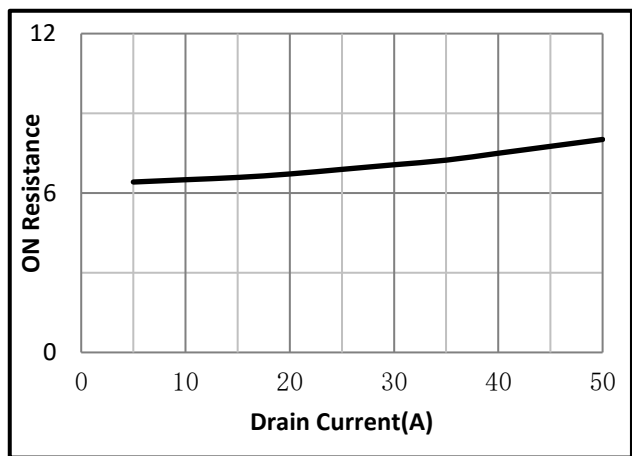

Fig.7 On-Resistance VS Gate Source Voltage

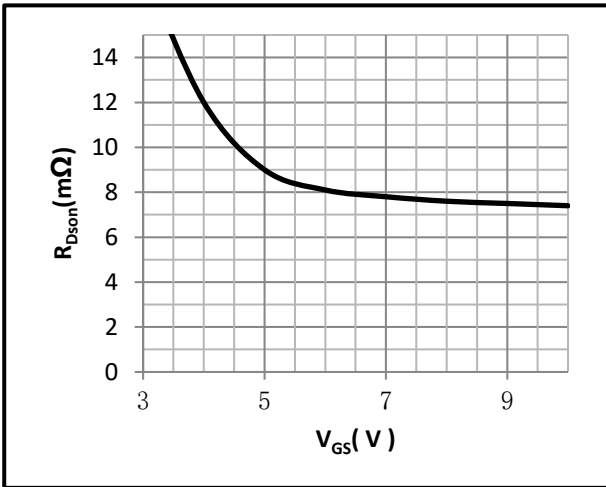
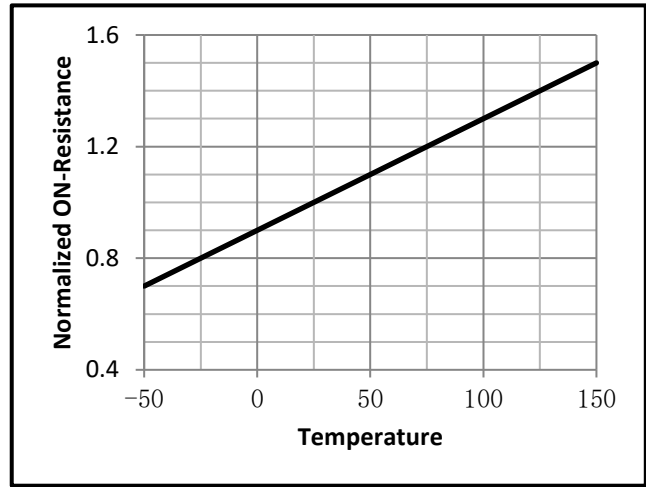

Fig.8 On-Resistance V.S Junction Temperature



• Channel characteristics curve(Q2)

Fig.9 Gate-Charge Characteristics

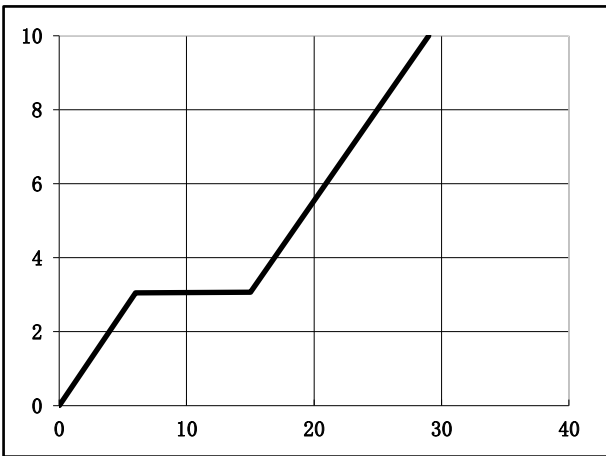

Fig.10 Capacitance Characteristics

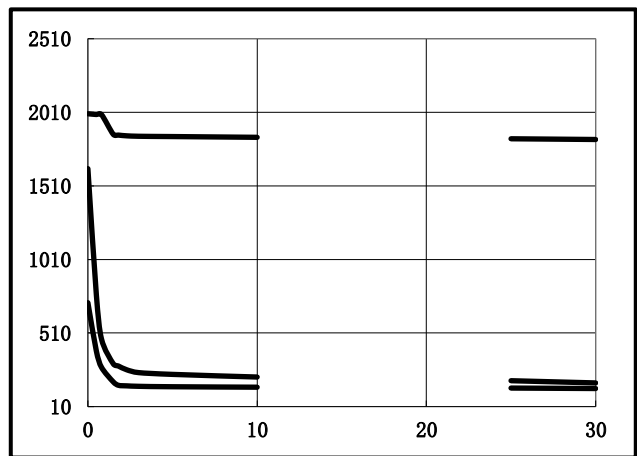

Fig.11 Power Dissipation

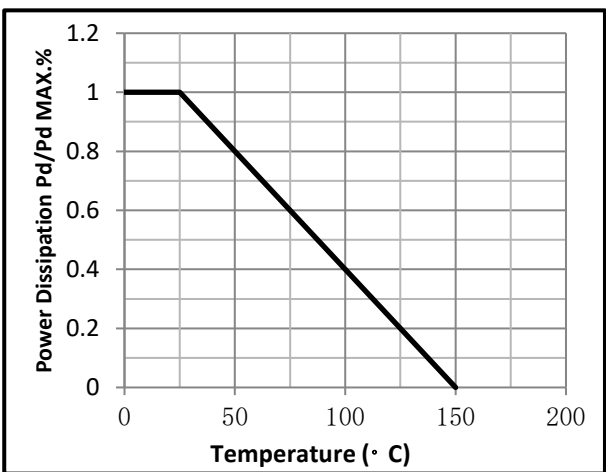

Fig.12 Typical output Characteristics

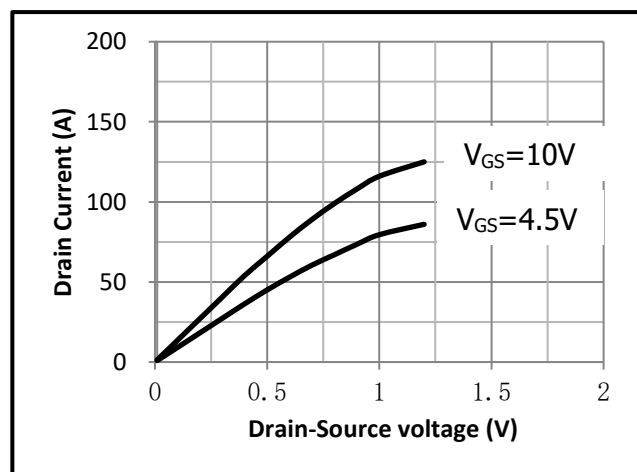

Fig.13 Threshold Voltage V.S Junction Temperature Fig.14 Resistance V.S Drain Current

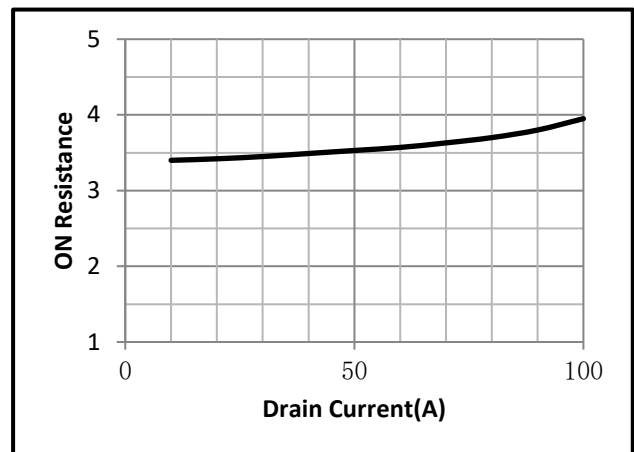
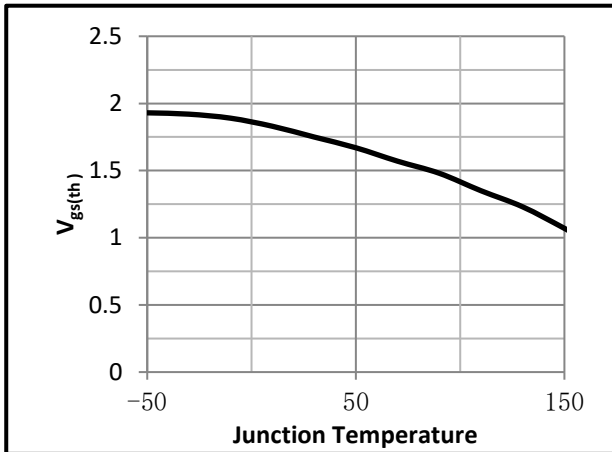

Fig.15 On-Resistance VS Gate Source Voltage Fig.16 On-Resistance V.S Junction Temperature

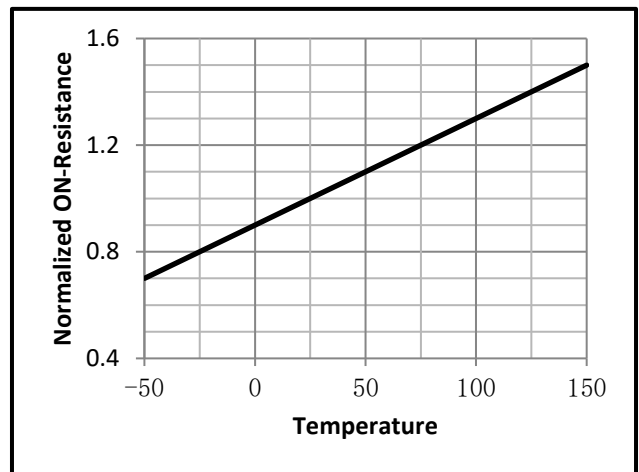
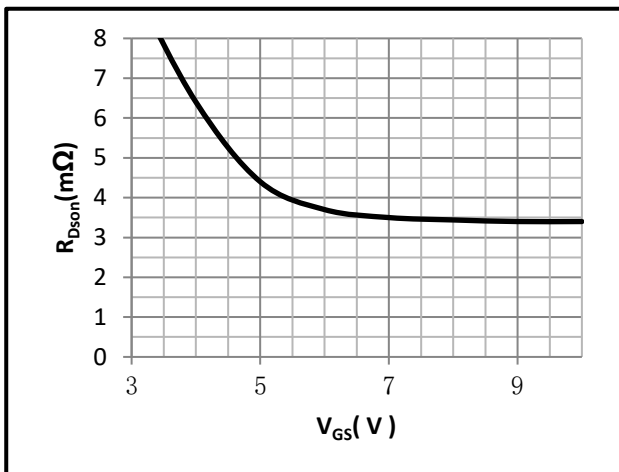

Fig.17 Switching Time Measurement Circuit

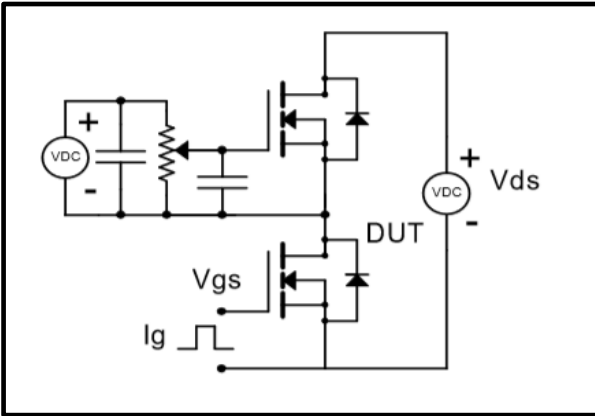

Fig.17 Gate Charge Waveform

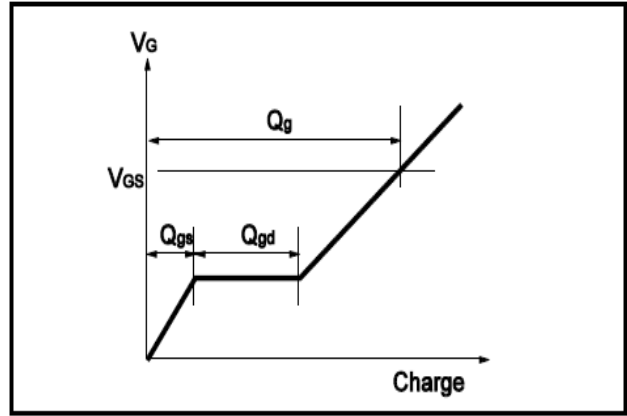

Fig.19 Switching Time Measurement Circuit

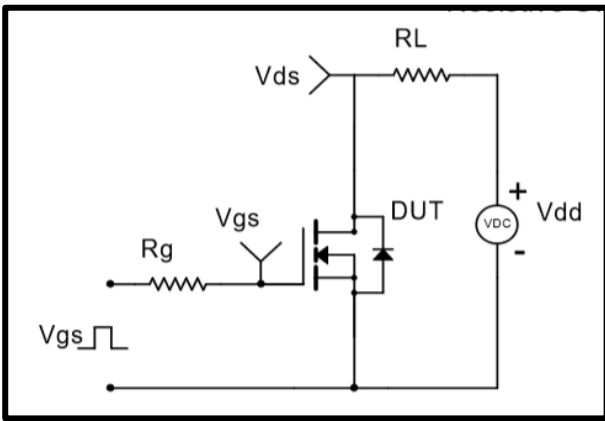

Fig.20 Gate Charge Waveform

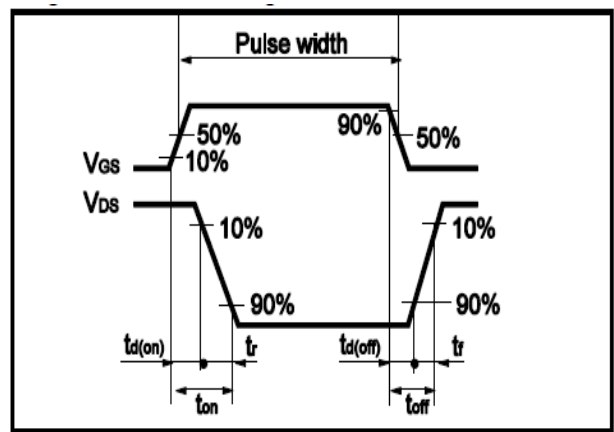

Fig.21 Avalanche Measurement Circuit

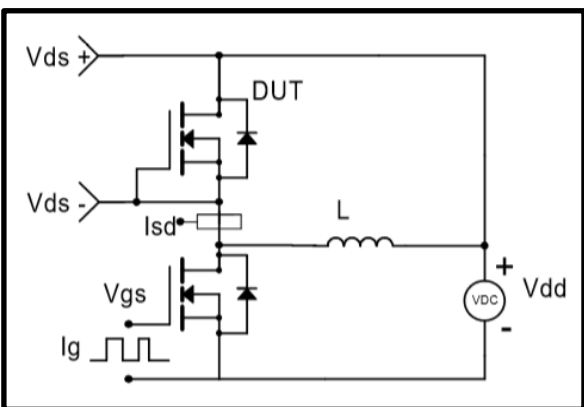
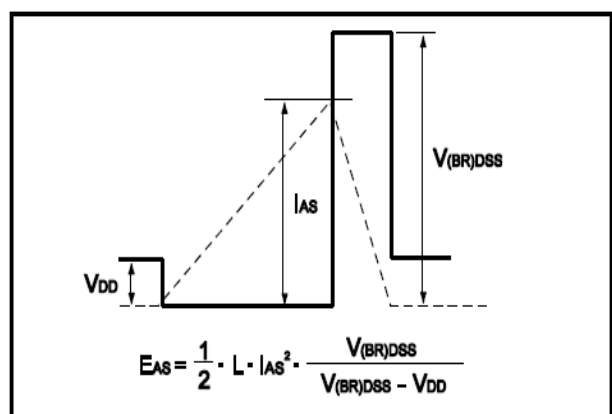
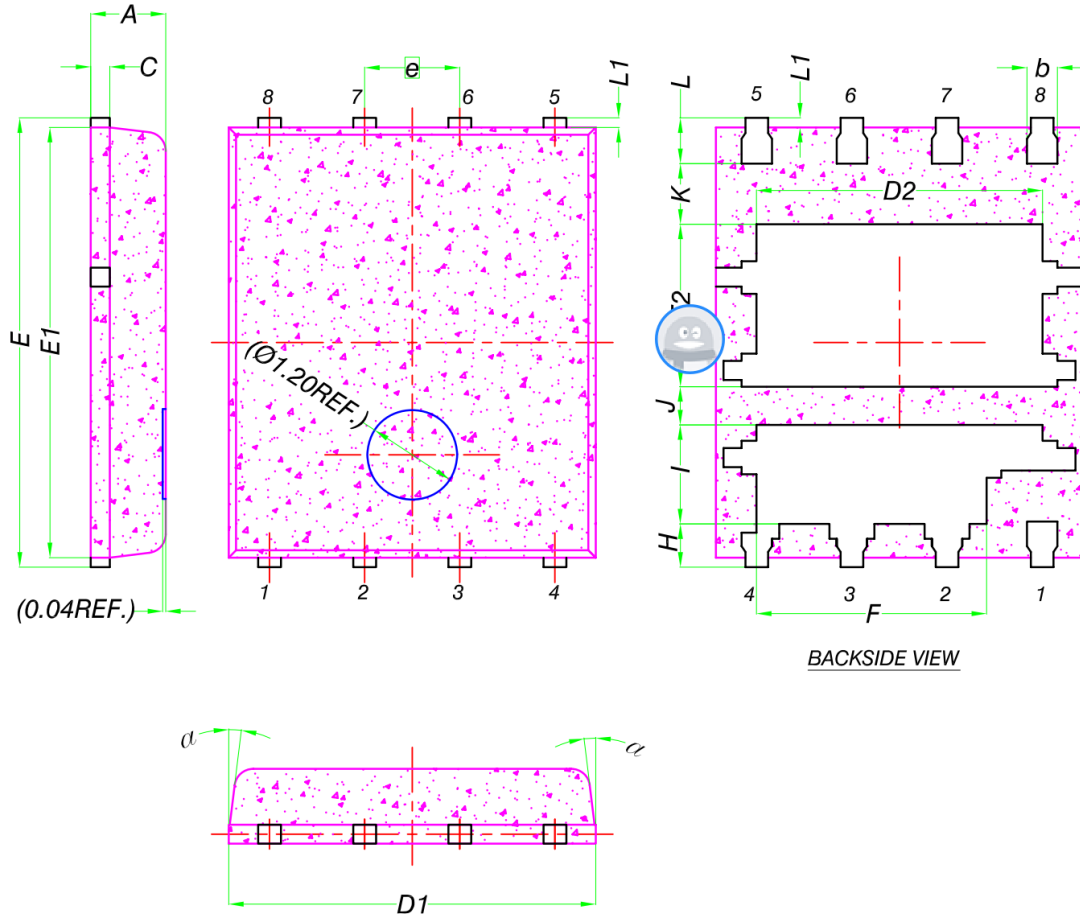

Fig.22 Avalanche Waveform



•Dimensions (DFN5x6)

Unit: mm



BACKSIDE VIEW

DIM.	MILLIMETERS		
	MIN.	NOM.	MAX.
A	0.90	1.00	1.10
b	0.33	0.41	0.51
C	0.20	0.25	0.30
D1	4.80	4.90	5.00
D2	3.61	3.81	3.96
E	5.90	6.00	6.10
E1	5.70	5.75	5.80
E2	2.02	2.17	2.32
e	1.27 BSC		
F	2.87	3.07	3.22
H	0.48	0.58	0.68
I	1.22	1.32	1.42
J	0.40	0.50	0.60
K	0.50	-	-
L	0.51	0.61	0.71
L1	0.06	0.13	0.20
α	0°	-	12°