

• General Description

The ZMS035N08HP combines advanced trench MOSFET technology with a low resistance package to provide extremely low $R_{DS(ON)}$.

• Features

- Advance device constructure
- Low $R_{DS(ON)}$ to minimize conduction loss
- Low Gate Charge for fast switching
- Low Thermal resistance

• Application

- Synchronous Rectification for AC-DC/DC-DC converter
- Oring switches
- Power Tools

• Ordering Information:

Part NO.	ZMS035N08HP
Marking	ZMS035N08H
Packing Information	Bulk Tube
Basic ordering unit (pcs)	500

• Absolute Maximum Ratings ($T_c = 25^\circ\text{C}$)

Parameter	Symbol	Rating	Unit
Drain-Source Voltage	V_{DS}	80	V
Gate-Source Voltage	V_{GS}	± 20	V
Continuous Drain Current	$I_{D@TC=25^\circ\text{C}}$	140	A
	$I_{D@TC=75^\circ\text{C}}$	106.4	A
	$I_{D@TC=100^\circ\text{C}}$	88.2	A
Pulsed Drain Current ①	I_{DM}	320	A
Total Power Dissipation($TC=25^\circ\text{C}$)	$P_D@TC=25^\circ\text{C}$	150	W
Operating Junction Temperature	T_J	-55 to 150	$^\circ\text{C}$
Storage Temperature	T_{STG}	-55 to 150	$^\circ\text{C}$
Single Pulse Avalanche Energy@ $L=0.1\text{mH}$	E_{AS}	125	mJ
Avalanche Current@ $L=0.1\text{mH}$	I_{AS}	50	A

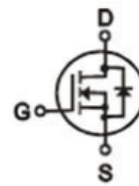
• Product Summary

$V_{DS} = 80\text{V}$

$R_{DS(ON)} = 3.5\text{m}\Omega$

$I_D = 140\text{A}$

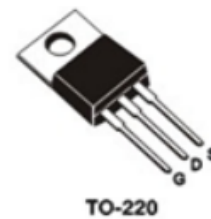

•Thermal resistance

Parameter	Symbol	Min.	Typ.	Max.	Unit
Thermal resistance, junction - case	R_{thJC}	-	-	0.75	° C/W
Thermal resistance, junction - ambient	R_{thJA}	-	-	70	° C/W
Soldering temperature, wavesoldering for 10s	T_{sold}	-	-	265	° C

•Electronic Characteristics

Parameter	Symbol	Condition	Min.	Typ	Max.	Unit
Drain-Source Breakdown Voltage	BV_{DSS}	$V_{GS} = 0V, I_D = 250\mu A$	80			V
Gate Threshold Voltage	$V_{GS(TH)}$	$V_{GS} = V_{DS}, I_D = 250\mu A$	2		4	V
Drain-Source Leakage Current	I_{DSS}	$V_{DS} = 80V, V_{GS} = 0V$			1.0	μA
Gate- Source Leakage Current	I_{GSS}	$V_{GS} = \pm 20V, V_{DS} = 0V$			± 100	nA
Static Drain-source On Resistance	$R_{DS(ON)}$	$V_{GS} = 10V, I_D = 30A$		3.5	5	m Ω
Forward Transconductance	g_{FS}	$V_{DS} = 10V, I_D = 40A$		28		s
Source-drain voltage	V_{SD}	$I_S = 30A$			1.28	V

•Electronic Characteristics

Parameter	Symbol	Condition	Min.	Typ	Max.	Unit
Input capacitance	C_{iss}	f = 1MHz	-	3100	-	pF
Output capacitance	C_{oss}		-	890	-	
Reverse transfer capacitance	C_{rss}		-	130	-	

•Gate Charge characteristics($T_a = 25^\circ C$)

Parameter	Symbol	Condition	Min.	Typ	Max.	Unit
Total gate charge	Q_g	$V_{DD} = 30V$	-	42	-	nC
Gate - Source charge	Q_{gs}	$I_D = 30A$	-	12	-	
Gate - Drain charge	Q_{gd}	$V_{GS} = 10V$	-	9	-	

Note: ① Pulse Test : Pulse width $\leq 10\mu s$, Duty cycle $\leq 1\%$;

Fig.1 Gate-Charge Characteristics

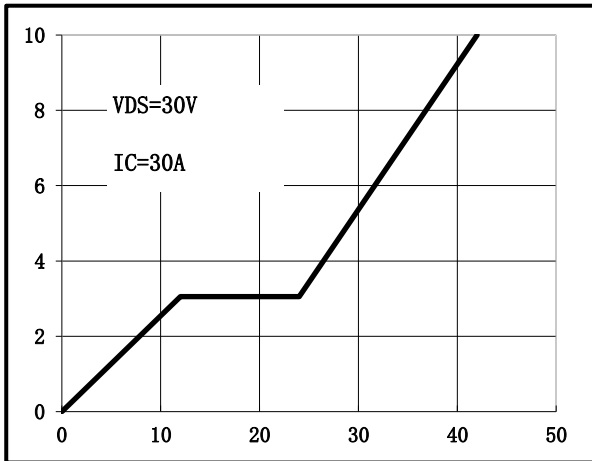

Fig.2 Capacitance Characteristics

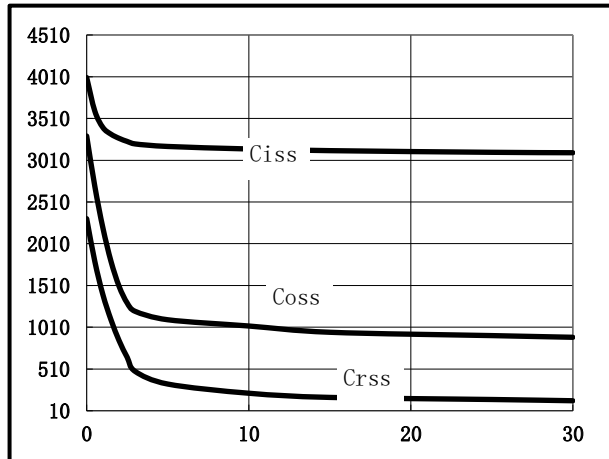

Fig.3 Power Dissipation

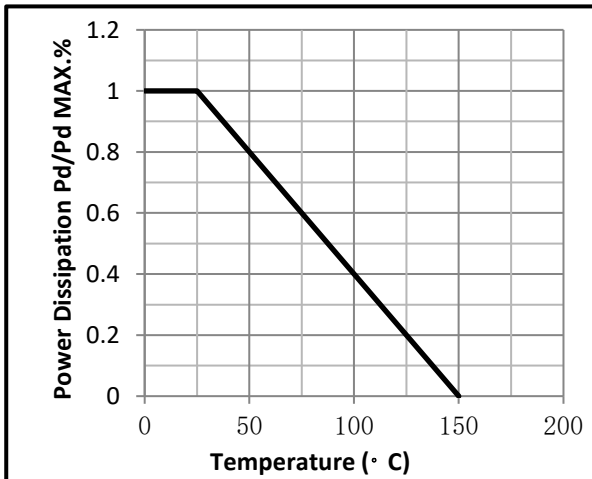

Fig.4 Typical output Characteristics

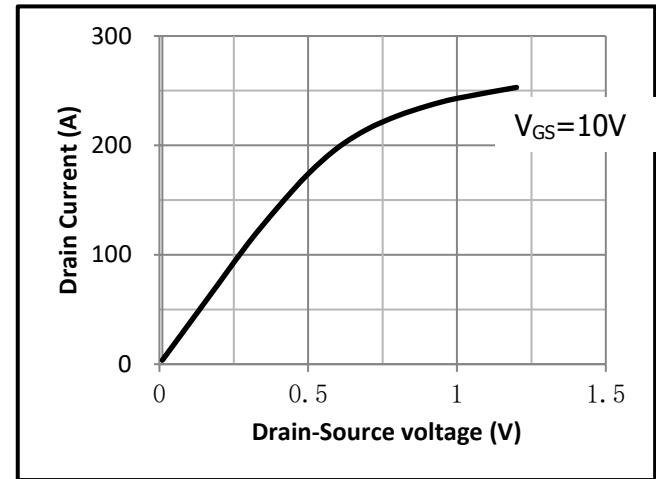

Fig.5 Threshold Voltage V.S Junction Temperature

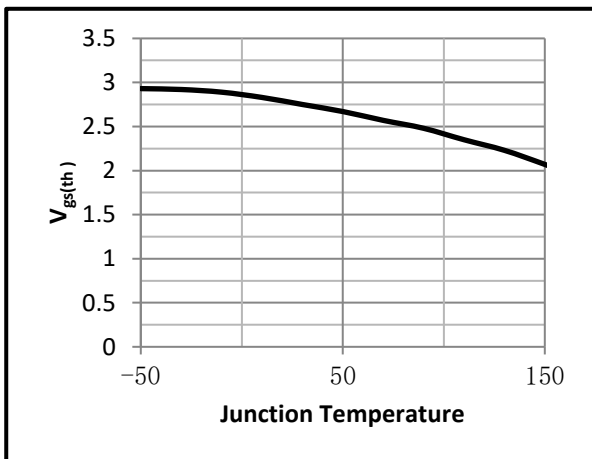

Fig.6 Resistance V.S Drain Current

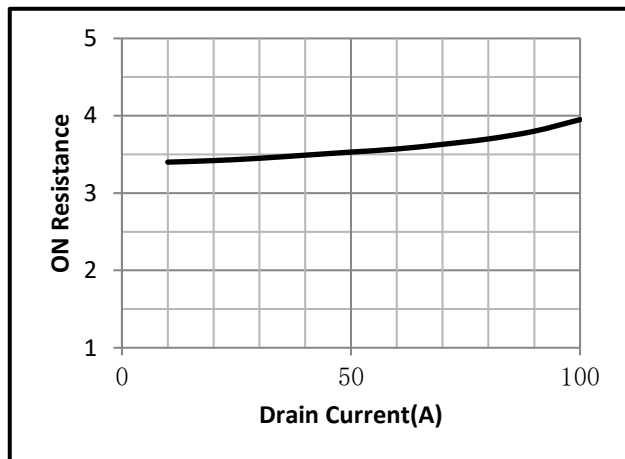

Fig.7 On-Resistance VS Gate Source Voltage

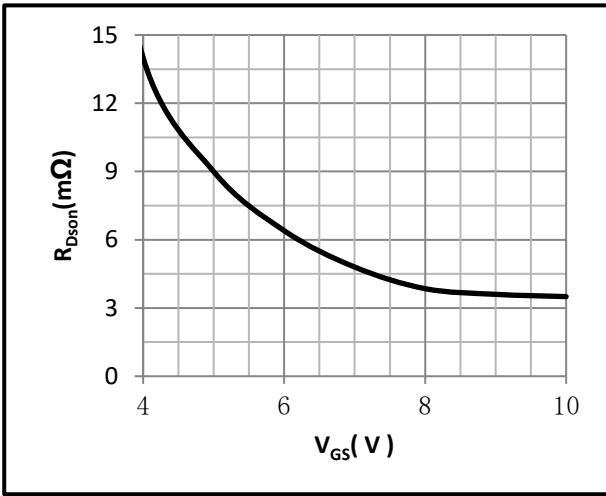

Fig.8 On-Resistance V.S Junction Temperature

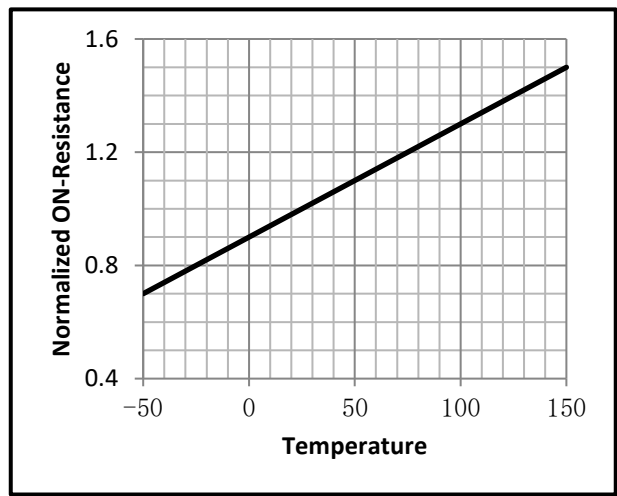

Fig.9 Switching Time Measurement Circuit

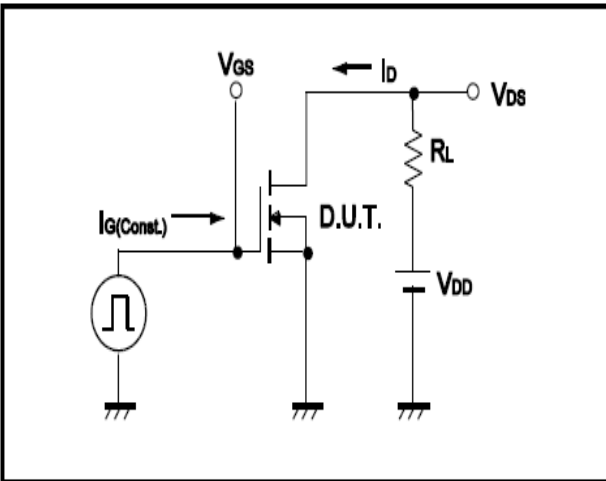

Fig.10 Gate Charge Waveform

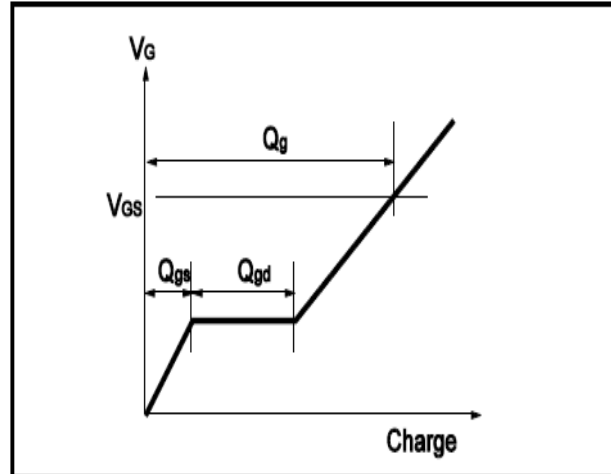

Fig.11 Switching Time Measurement Circuit

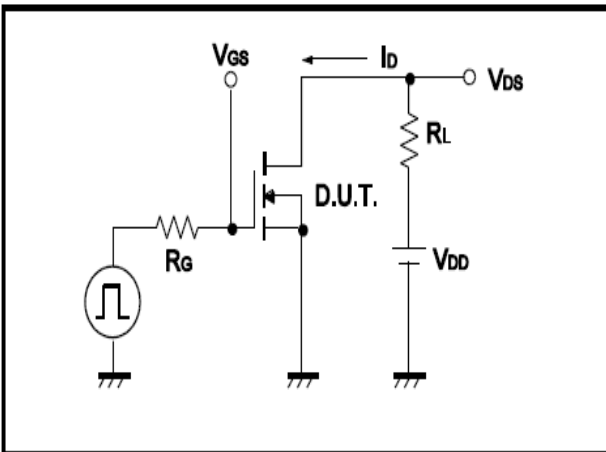
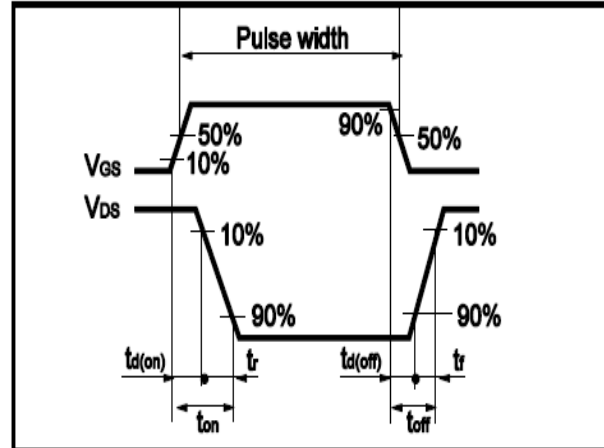

Fig.12 Gate Charge Waveform



•Dimensions (TO-220)

Unit: mm

SYMBOL	min	nom	max	SYMBOL	min	nom	max
A	4.00		4.80	E	9.90		10.70
B	1.20		1.50	e		2.54	
B1	1.00		1.40	F	1.10		1.45
b1	0.65		1.00	L	12.50		14.50
c	0.35		0.75	L1	3.00	3.50	4.00
D	15.00		16.50	Q	2.50		3.00
D1	5.90		6.90	Q1	2.00		3.00
				ΦP	3.60		3.90

