

**• General Description**

It combines advanced MOSFET technology with a low resistance package to provide extremely low  $R_{DS(ON)}$ .

**• Features**

- Advance device constructure
- Low  $R_{DS(ON)}$  to minimize conduction loss
- Low Gate Charge for fast switching
- Low Thermal resistance

**• Application**

- Synchronous Rectification for AC-DC/DC-DC converter
- Power Tools

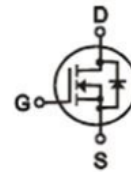
**• Product Summary**

$V_{DS} = 60V$

$R_{DS(ON)} = 5.2m\Omega$

$I_D = 80A$

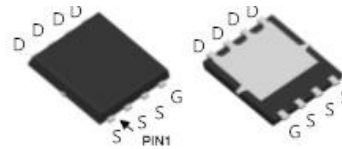

DFN5 x 6

**• Ordering Information:**

Part NO.	ZMS052N06N
Marking	ZMS052N06
Packing Information	REEL TAPE
Basic ordering unit (pcs)	3000

**• Absolute Maximum Ratings ( $T_C = 25^\circ C$ )**

Parameter	Symbol	Rating	Unit
Drain-Source Voltage	$V_{DS}$	60	V
Gate-Source Voltage	$V_{GS}$	$\pm 20$	V
Continuous Drain Current	$I_{D@TC=25^\circ C}$	80	A
	$I_{D@TC=75^\circ C}$	61	A
	$I_{D@TC=100^\circ C}$	50	A
Pulsed Drain Current ①	$I_{DM}$	240	A
Total Power Dissipation	$P_D@TC=25^\circ C$	85	W
Total Power Dissipation	$P_D@TA=25^\circ C$	3.4	W
Operating Junction Temperature	$T_J$	-55 to 150	$^\circ C$
Storage Temperature	$T_{STG}$	-55 to 150	$^\circ C$
Single Pulse Avalanche Energy	$E_{AS}$	280	mJ

**•Thermal resistance**

Parameter	Symbol	Min.	Typ.	Max.	Unit
Thermal resistance, junction - case	$R_{thJC}$			1.5	° C/W
Thermal resistance, junction - ambient	$R_{thJA}$	-	-	37	° C/W
Soldering temperature, wavesoldering for 10s	$T_{sold}$	-	-	265	° C

**•Electronic Characteristics**

Parameter	Symbol	Condition	Min.	Typ	Max.	Unit
Drain-Source Breakdown Voltage	$BV_{DSS}$	$V_{GS} = 0V, I_D = 250\mu A$	60			V
Gate Threshold Voltage	$V_{GS(TH)}$	$V_{GS} = V_{DS}, I_D = 250\mu A$	1.5		2.5	V
Drain-Source Leakage Current	$I_{DSS}$	$V_{DS} = 0.8 BV_{DSS}, V_{GS} = 0V$			1.0	$\mu A$
Gate- Source Leakage Current	$I_{GSS}$	$V_{GS} = \pm 20V, V_{DS} = 0V$			$\pm 100$	nA
Static Drain-source On Resistance	$R_{DS(ON)}$	$V_{GS} = 10V, I_D = 10A$		5.2	6.5	m $\Omega$
		$V_{GS} = 4.5V, I_D = 5A$		6.8	8.5	m $\Omega$
Forward Transconductance	$g_{FS}$	$V_{DS} = 25V, I_D = 10A$		16		s
Source-drain voltage	$V_{SD}$	$I_S = 10A$			1.28	V

**•Electronic Characteristics**

Parameter	Symbol	Condition	Min.	Typ	Max.	Unit
Input capacitance	$C_{iss}$	$f = 1MHz$ $V_{DS} = 25V$	-	1910	-	pF
Output capacitance	$C_{oss}$		-	960	-	
Reverse transfer capacitance	$C_{rss}$		-	91	-	

**•Gate Charge characteristics( $T_a = 25^\circ C$ )**

Parameter	Symbol	Condition	Min.	Typ	Max.	Unit
Total gate charge	$Q_g$	$V_{DD} = 25V$	-	29	-	nC
Gate - Source charge	$Q_{gs}$	$I_D = 8A$	-	4.4	-	
Gate - Drain charge	$Q_{gd}$	$V_{GS} = 10V$	-	7.2	-	

Note: ① Pulse Test : Pulse width  $\leq 300\mu s$ , Duty cycle  $\leq 2\%$  ;

Fig.1 Gate-Charge Characteristics

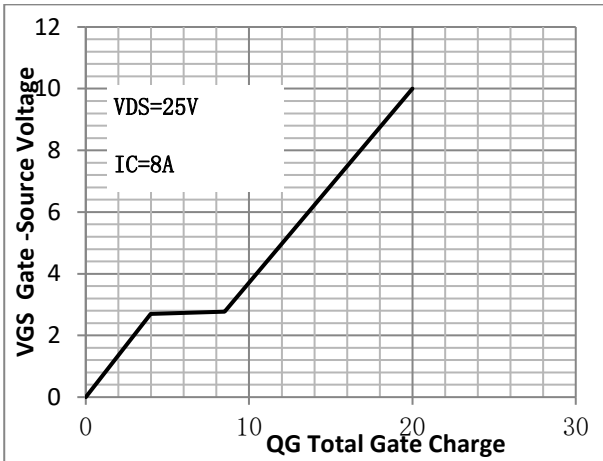

Fig.2 Capacitance Characteristics

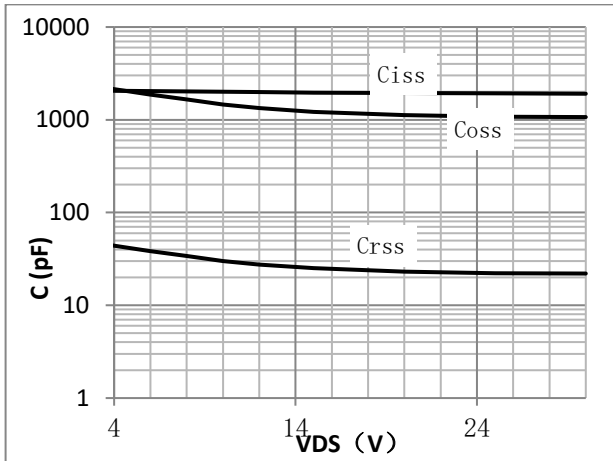

Fig.3 Power Dissipation

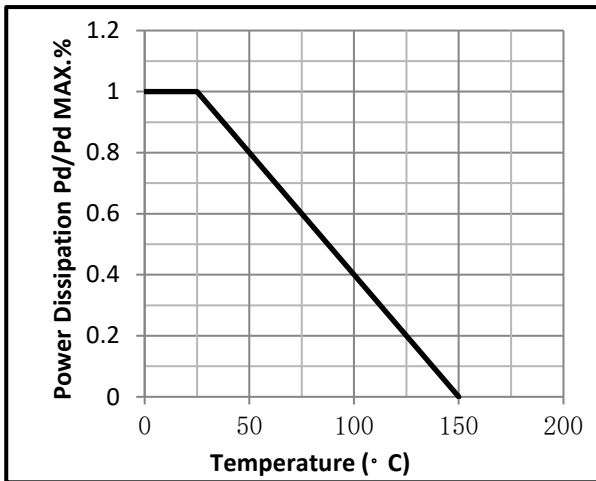

Fig.4 Typical output Characteristics

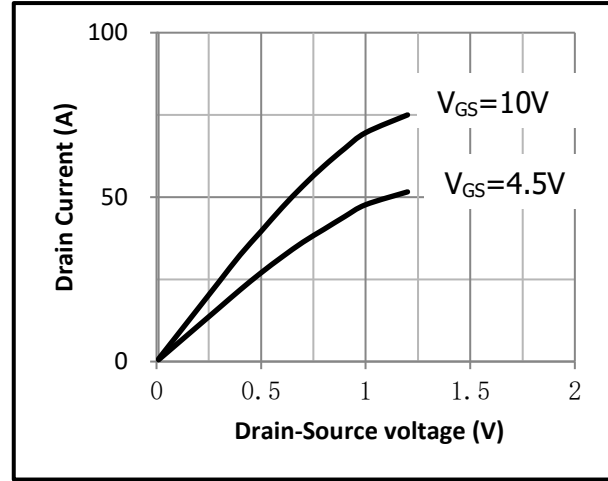

Fig.5 Threshold Voltage V.S Junction Temperature

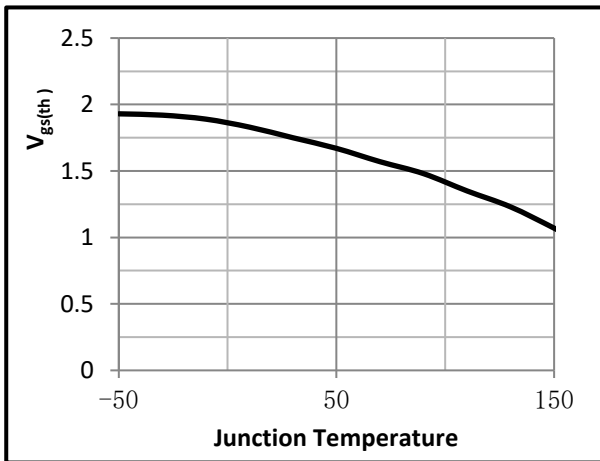

Fig.6 Resistance V.S Drain Current

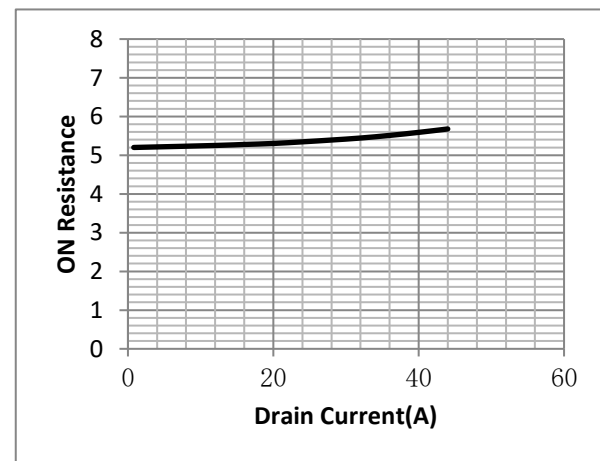

Fig.7 On-Resistance VS Gate Source Voltage

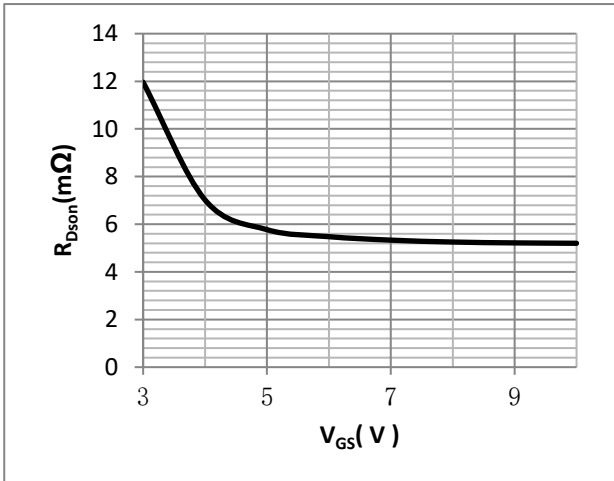

Fig.8 On-Resistance V.S Junction Temperature

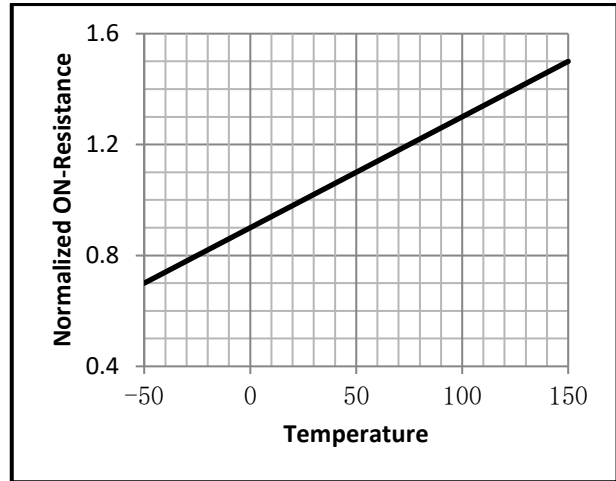

Fig.9 SOA Maximum Safe Operating Area

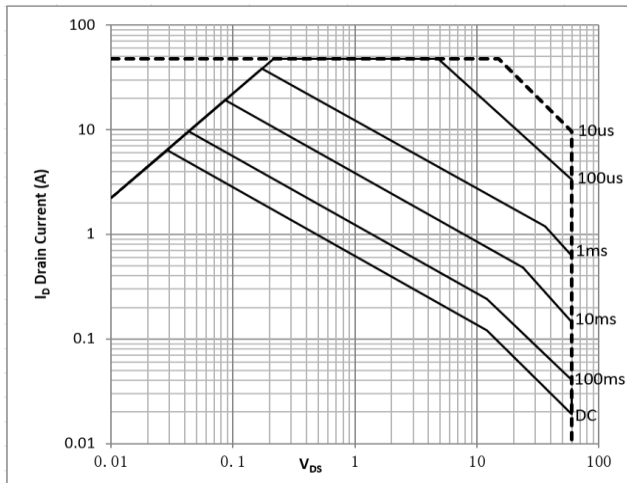

Fig.10  $I_D$ -Junction Temperature

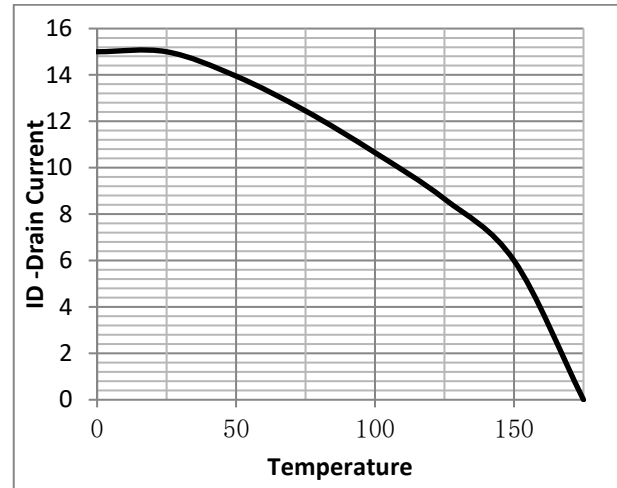

Fig.11 Switching Time Measurement Circuit

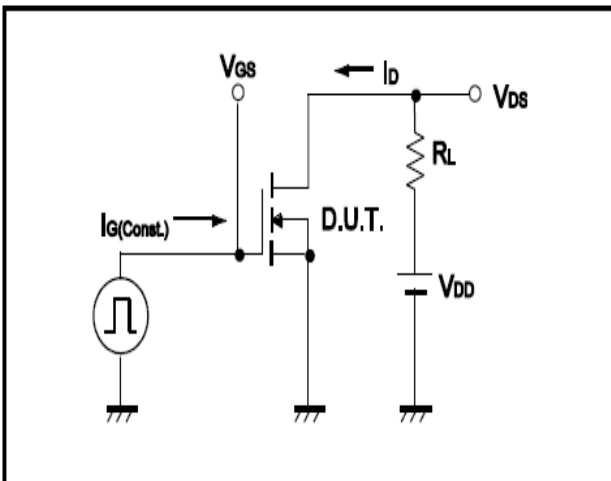

Fig.12 Gate Charge Waveform

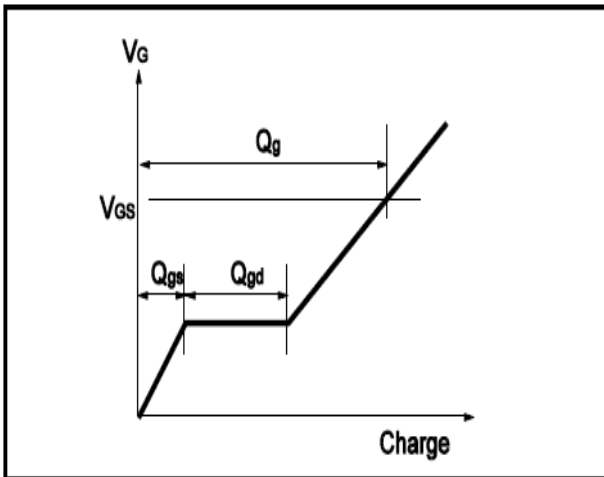

Fig.13 Switching Time Measurement Circuit

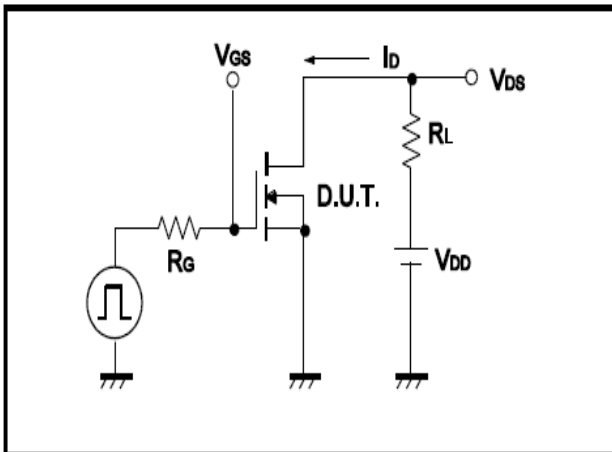
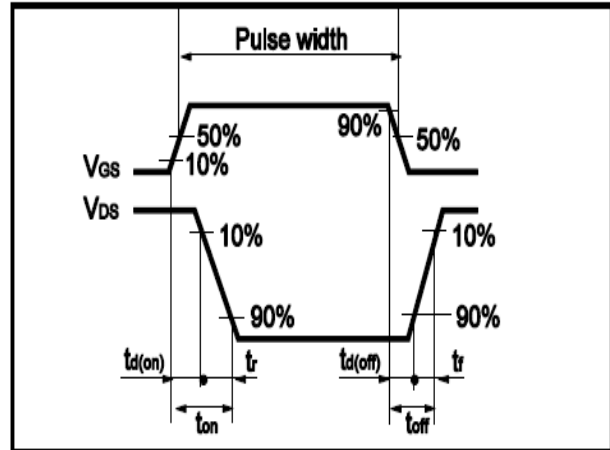

Fig.14 Gate Charge Waveform





•Dimensions (DFN5x6)

Unit: mm

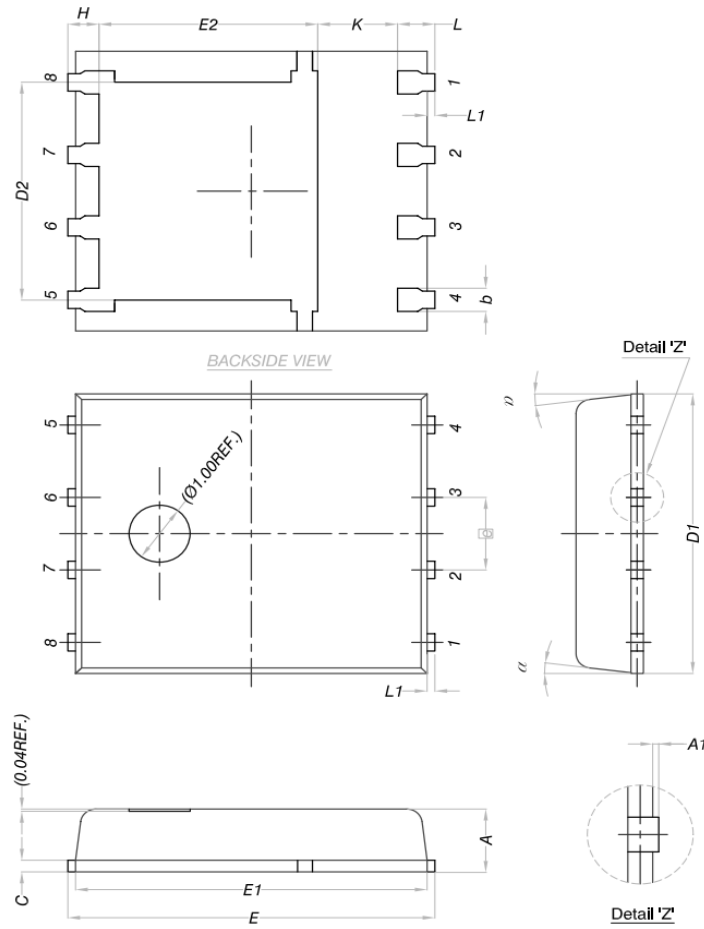

DIM.	MILLIMETERS		
	MIN.	NOM.	MAX.
A	0.90	1.00	1.10
A1	0	-	0.05
b	0.33	0.41	0.51
C	0.20	0.25	0.30
D1	4.80	4.90	5.00
D2	3.61	3.81	3.96
E	5.90	6.00	6.10
E1	5.70	5.75	5.80
E2	3.38	3.58	3.78
$\square$ e	1.27 BSC		
H	0.41	0.51	0.61
K	1.10	-	-
L	0.51	0.61	0.71
L1	0.06	0.13	0.20
α	0°	-	12°