

**• General Description**

The ZMS050N06N combines advanced trench MOSFET technology with a low resistance package to provide extremely low  $R_{DS(ON)}$ .

**• Features**

- Advance device constructure
- Low  $R_{DS(ON)}$  to minimize conduction loss
- Low Gate Charge for fast switching
- Low Thermal resistance

**• Application**

- Synchronous Rectification for AC-DC/DC-DC converter
- Oring switches
- Power Tools

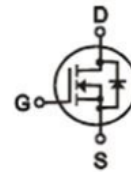
**• Product Summary**

$V_{DS} = 60V$

$R_{DS(ON)} = 5m\Omega$

$I_D = 70A$

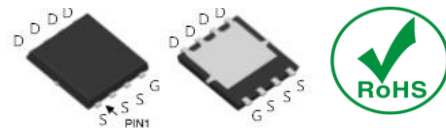
**• Ordering Information:**

Part NO.	ZMS050N06N
Marking	ZMS050N06
Packing Information	REEL TAPE
Basic ordering unit (pcs)	2500

**• Absolute Maximum Ratings ( $T_C = 25^\circ C$ )**

Parameter	Symbol	Rating	Unit
Drain-Source Voltage	$V_{DS}$	60	V
Gate-Source Voltage	$V_{GS}$	$\pm 20$	V
Continuous Drain Current	$I_D @ TC=25^\circ C$	70	A
	$I_D @ TC=75^\circ C$	53	A
	$I_D @ TC=100^\circ C$	44	A
Pulsed Drain Current ①	$I_{DM}$	210	A
Total Power Dissipation( $TC=25^\circ C$ )	$P_D @ TC=25^\circ C$	80	W
Total Power Dissipation( $TA=25^\circ C$ )	$P_D @ TA=25^\circ C$	2.5	W
Operating Junction Temperature	$T_J$	-55 to 150	$^\circ C$
Storage Temperature	$T_{STG}$	-55 to 150	$^\circ C$
Single Pulse Avalanche Energy@ $L=0.1mH$	$E_{AS}$	70	mJ

**•Thermal resistance**

Parameter	Symbol	Min.	Typ.	Max.	Unit
Thermal resistance, junction - case	R <sub>thJC</sub>	-	-	1.6	° C/W
Thermal resistance, junction - ambient	R <sub>thJA</sub>	-	-	50	° C/W
Soldering temperature, wavesoldering for 10s	T <sub>sold</sub>	-	-	265	° C

**•Electronic Characteristics**

Parameter	Symbol	Condition	Min.	Typ	Max.	Unit
Drain-Source Breakdown Voltage	BV <sub>DSS</sub>	V <sub>GS</sub> =0V, I <sub>D</sub> =250uA	60			V
Gate Threshold Voltage	V <sub>GS(TH)</sub>	V <sub>GS</sub> =V <sub>DS</sub> , I <sub>D</sub> =250uA	1.5		2.5	V
Drain-Source Leakage Current	I <sub>DSS</sub>	V <sub>DS</sub> =0.8 BV <sub>DSS</sub> , V <sub>GS</sub> =0V			1.0	uA
Gate- Source Leakage Current	I <sub>GSS</sub>	V <sub>GS</sub> =±20V, V <sub>DS</sub> =0V			±100	nA
Static Drain-source On Resistance	R <sub>DS(ON)</sub>	V <sub>GS</sub> =10V, I <sub>D</sub> =20A		5.0	6.5	mΩ
		V <sub>GS</sub> =4.5V, I <sub>D</sub> =16A		7.0	8.5	mΩ
Forward Transconductance	g <sub>FS</sub>	V <sub>DS</sub> =25V, I <sub>D</sub> =5A		20		s
Source-drain voltage	V <sub>SD</sub>	I <sub>S</sub> =20A			1.28	V

**•Electronic Characteristics**

Parameter	Symbol	Condition	Min.	Typ	Max.	Unit
Input capacitance	C <sub>iss</sub>	f = 1MHz V <sub>DS</sub> =25V	-	1650	-	pF
Output capacitance	C <sub>oss</sub>		-	930	-	
Reverse transfer capacitance	C <sub>rss</sub>		-	19	-	

**•Gate Charge characteristics(T<sub>a</sub> = 25°C)**

Parameter	Symbol	Condition	Min.	Typ	Max.	Unit
Total gate charge	Q <sub>g</sub>	V <sub>DD</sub> = 25V	-	21	-	nC
Gate - Source charge	Q <sub>gs</sub>	I <sub>D</sub> = 8A	-	4.4	-	
Gate - Drain charge	Q <sub>gd</sub>	V <sub>GS</sub> = 10V	-	2.9	-	

Note: ① Pulse Test : Pulse width ≤ 300μs, Duty cycle ≤ 2% ;

Fig.1 Gate-Charge Characteristics

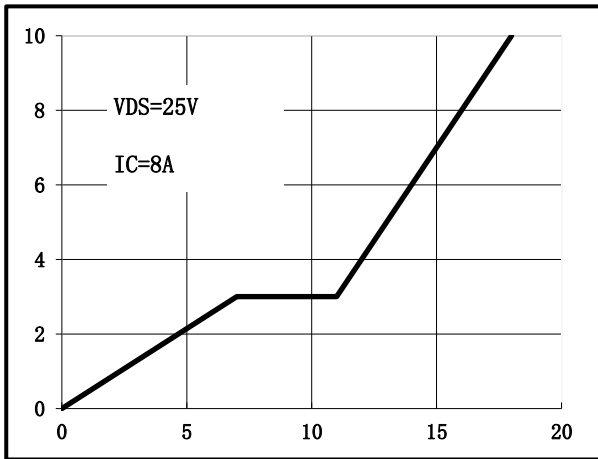

Fig.2 Capacitance Characteristics

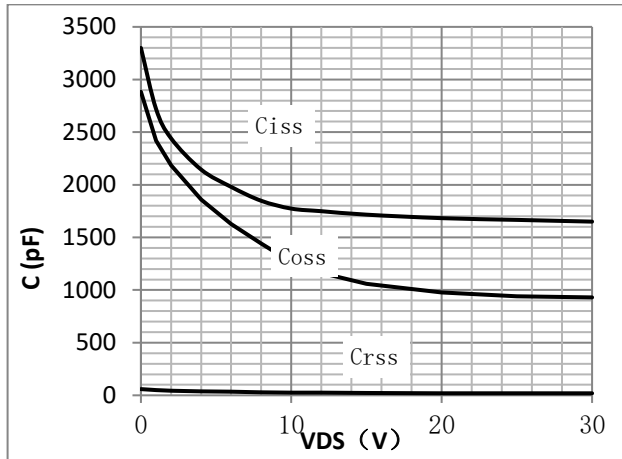

Fig.3 Power Dissipation

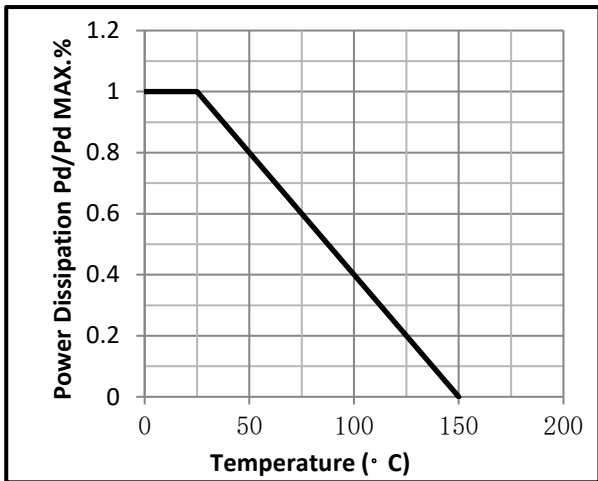

Fig.4 Typical output Characteristics

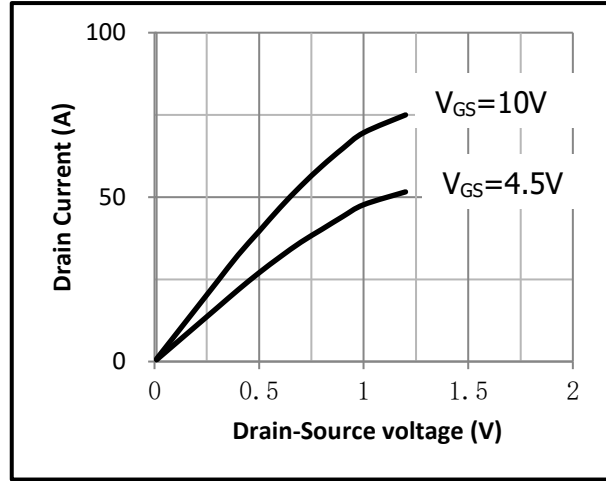

Fig.5 Threshold Voltage V.S Junction Temperature

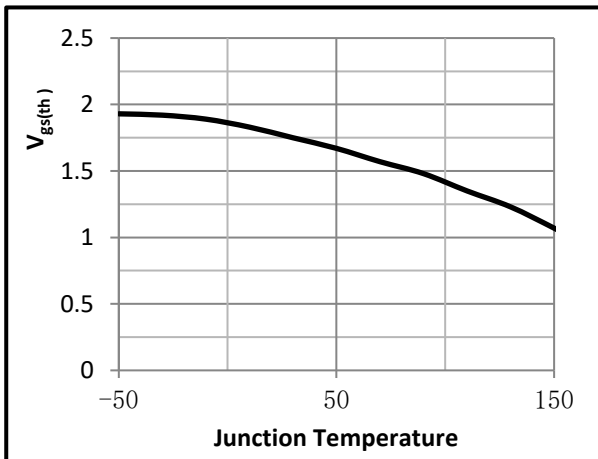

Fig.6 Resistance V.S Drain Current

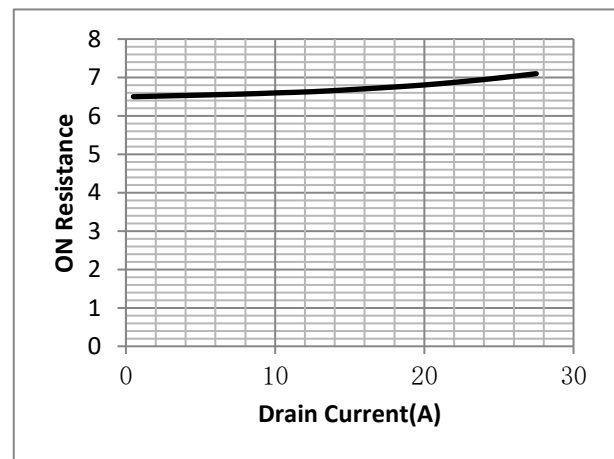

Fig.7 On-Resistance VS Gate Source Voltage

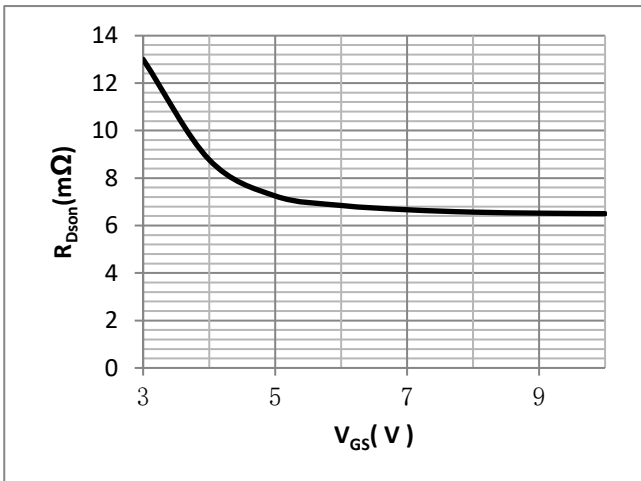

Fig.8 On-Resistance V.S Junction Temperature

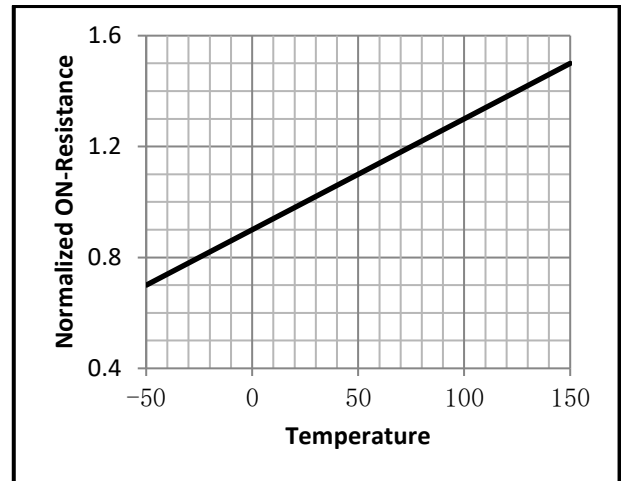

Fig.9 SOA Maximum Safe Operating Area

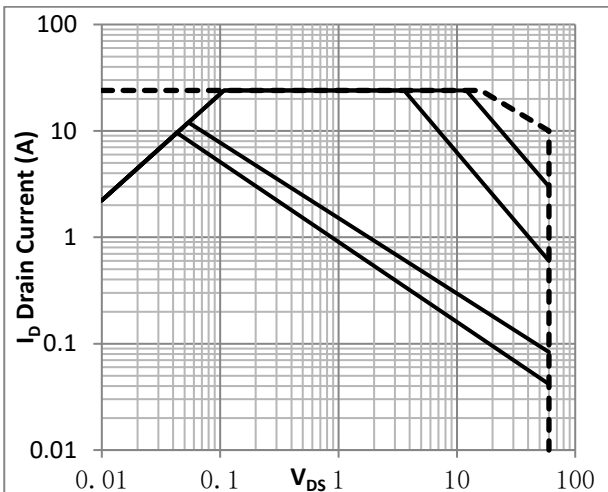

Fig.10  $I_D$ -Junction Temperature

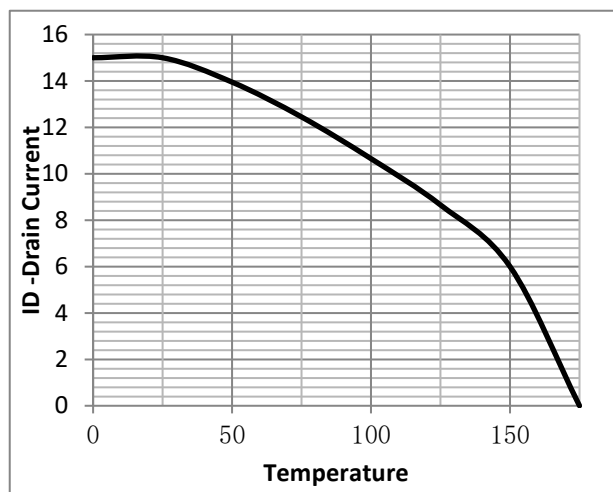

Fig.11 Switching Time Measurement Circuit

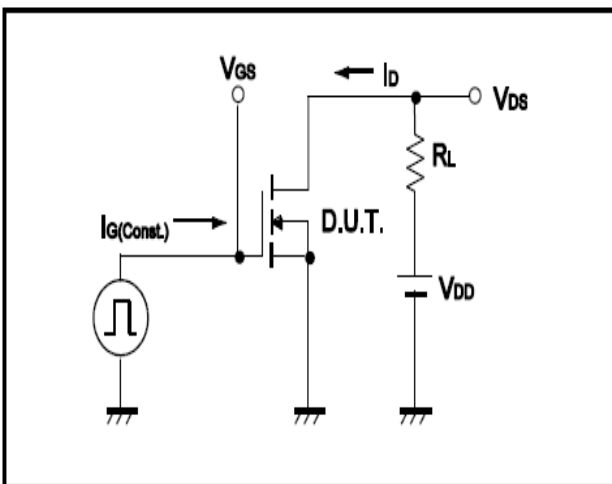

Fig.12 Gate Charge Waveform

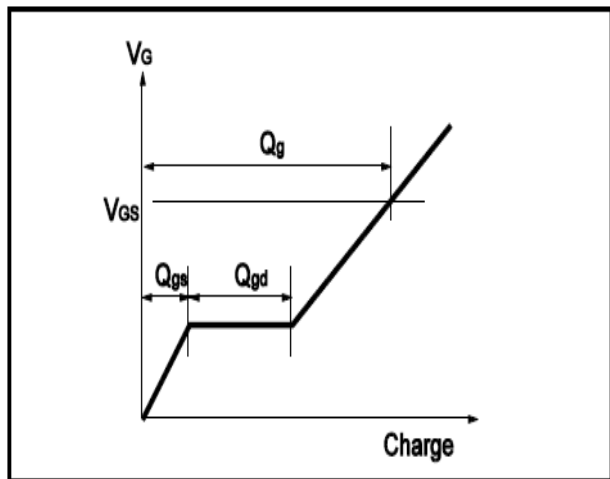

Fig.13 Switching Time Measurement Circuit

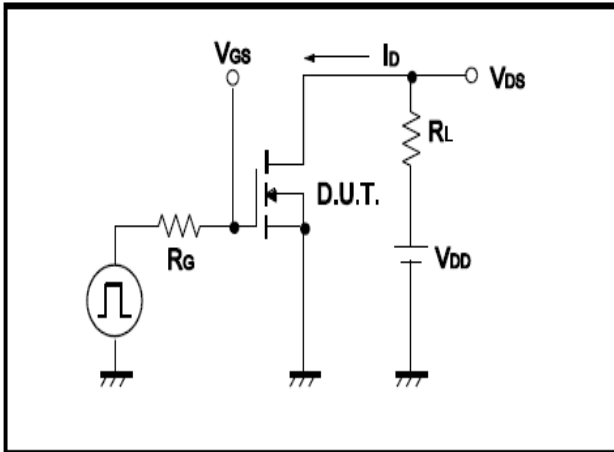
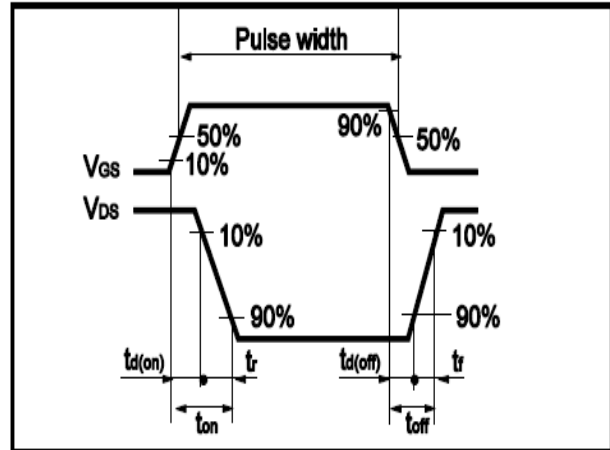

Fig.14 Gate Charge Waveform





•Dimensions (DFN5x6)

Unit: mm

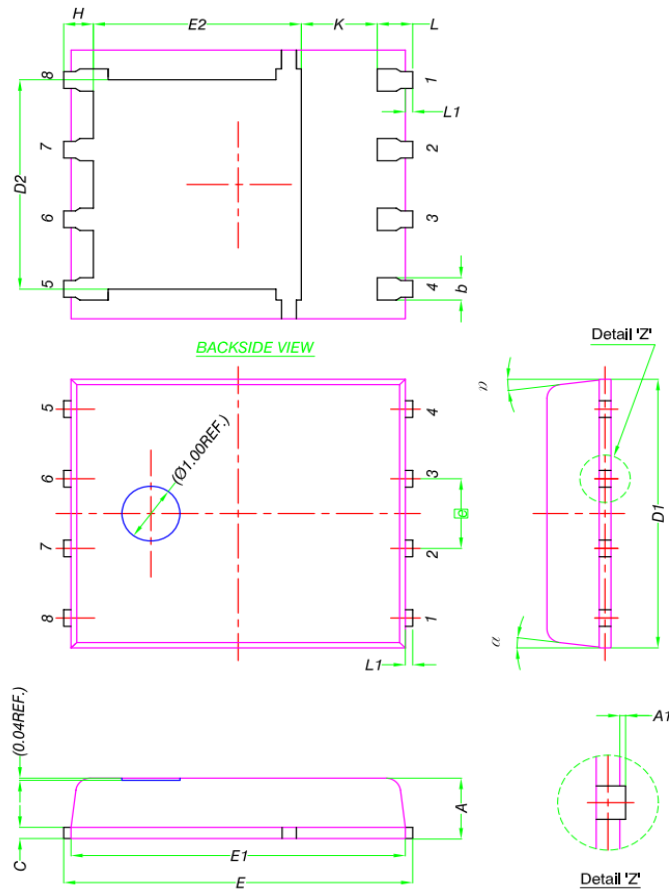

DIM.	MILLIMETERS		
	MIN.	NOM.	MAX.
A	0.90	1.00	1.10
A1	0	-	0.05
b	0.33	0.41	0.51
C	0.20	0.25	0.30
D1	4.80	4.90	5.00
D2	3.61	3.81	3.96
E	5.90	6.00	6.10
E1	5.70	5.75	5.80
E2	3.38	3.58	3.78
e	1.27 BSC		
H	0.41	0.51	0.61
K	1.10	-	-
L	0.51	0.61	0.71
L1	0.06	0.13	0.20
α	0°	-	12°