

• General Description

It combines advanced trench MOSFET technology with a low resistance package to provide extremely low $R_{DS(ON)}$.

• Features

- Advance device constructure
- Low $R_{DS(ON)}$ to minimize conduction loss
- Low Gate Charge for fast switching
- Low Thermal resistance

• Application

- Synchronous Rectification for AC-DC/DC-DC converter
- Power Tools

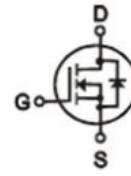
• Product Summary

$V_{DS} = 60V$

$R_{DS(ON)} = 9m\Omega$

$I_D = 50A$

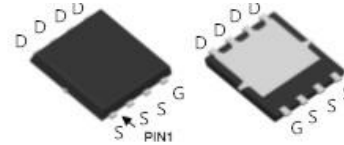

DFN5 x 6

• Ordering Information:

Part NO.	ZMS090N06N
Marking	ZMS090N06
Packing Information	REEL TAPE
Basic ordering unit (pcs)	3000

• Absolute Maximum Ratings (T_C = 25°C)

Parameter	Symbol	Rating	Unit
Drain-Source Voltage	V_{DS}	60	V
Gate-Source Voltage	V_{GS}	±20	V
Continuous Drain Current	$I_{D@TC=25^{\circ}C}$	50	A
	$I_{D@TC=75^{\circ}C}$	38	A
	$I_{D@TC=100^{\circ}C}$	31.5	A
Pulsed Drain Current ①	I_{DM}	150	A
Total Power Dissipation(TC=25°C)	$P_D@TC=25^{\circ}C$	85	W
Total Power Dissipation(TA=25°C)	$P_D@TA=25^{\circ}C$	3.4	W
Operating Junction Temperature	T_J	-55 to 150	°C
Storage Temperature	T_{STG}	-55 to 150	°C
Single Pulse Avalanche Energy@L=0.1mH	E_{AS}	85	mJ

•Thermal resistance

Parameter	Symbol	Min.	Typ.	Max.	Unit
Thermal resistance, junction - case	R _{thJC}	-	-	1.5	° C/W
Thermal resistance, junction - ambient	R _{thJA}	-	-	37	° C/W
Soldering temperature, wavesoldering for 10s	T _{sold}	-	-	265	° C

•Electronic Characteristics

Parameter	Symbol	Condition	Min.	Typ	Max.	Unit
Drain-Source Breakdown Voltage	BV _{DSS}	V _{GS} = 0V, I _D = 250uA	60			V
Gate Threshold Voltage	V _{GS(TH)}	V _{GS} = V _{DS} , I _D = 250uA	1.2		2.5	V
Drain-Source Leakage Current	I _{DSS}	V _{DS} = 60V, V _{GS} = 0V			1.0	uA
Gate- Source Leakage Current	I _{GSS}	V _{GS} = ±20V, V _{DS} = 0V			±100	nA
Static Drain-source On Resistance	R _{DS(ON)}	V _{GS} = 10V, I _D = 12A		9	11	mΩ
		V _{GS} = 4.5V, I _D = 10A		12	14	mΩ
Forward Transconductance	g _{FS}	V _{DS} = 25V, I _D = 10A		14		s
Source-drain voltage	V _{SD}	I _S = 12A			1.28	V

•Electronic Characteristics

Parameter	Symbol	Condition	Min.	Typ	Max.	Unit
Input capacitance	C _{iss}	f = 1MHz	-	960	-	pF
Output capacitance	C _{oss}		-	530	-	
Reverse transfer capacitance	C _{rss}		-	65	-	

•Gate Charge characteristics(T_a = 25°C)

Parameter	Symbol	Condition	Min.	Typ	Max.	Unit
Total gate charge	Q _g	V _{DD} = 25V	-	22	-	nC
Gate - Source charge	Q _{gs}	I _D = 8A	-	2.2	-	
Gate - Drain charge	Q _{gd}	V _{GS} = 10V	-	7	-	

Note: ① Pulse Test : Pulse width ≤ 300μs, Duty cycle ≤ 2% ;

Fig.1 Gate-Charge Characteristics

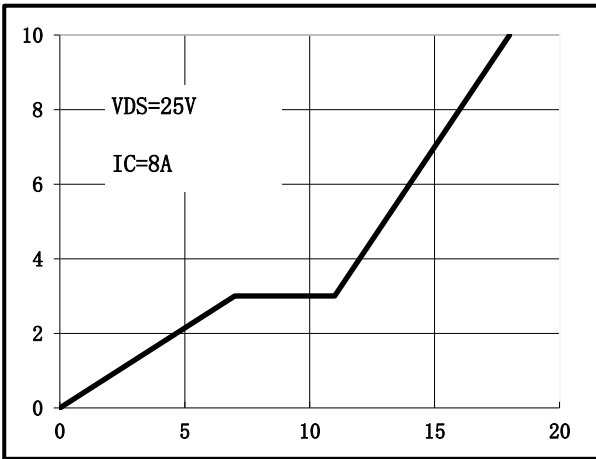

Fig.2 Capacitance Characteristics

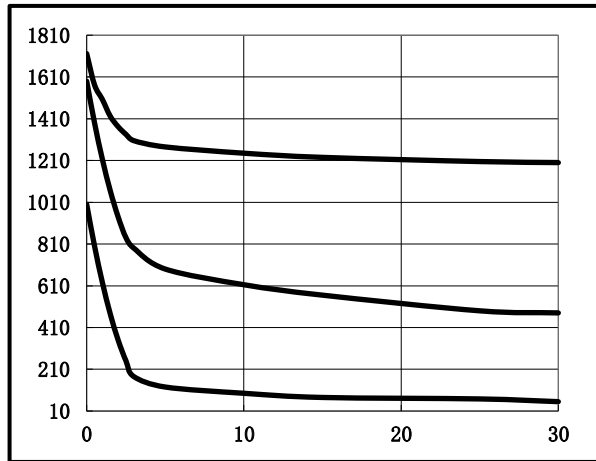

Fig.3 Power Dissipation

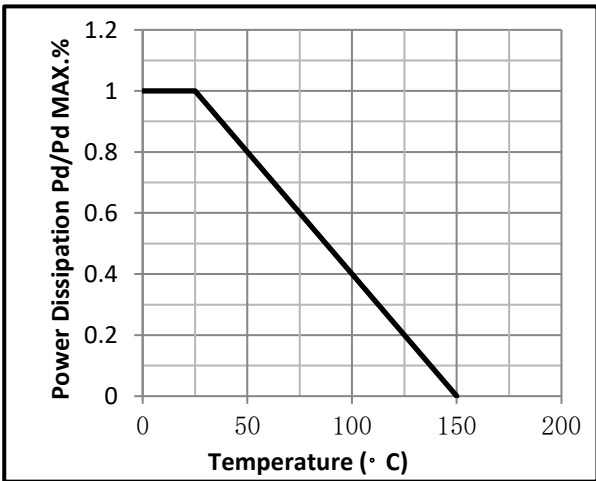

Fig.4 Typical output Characteristics

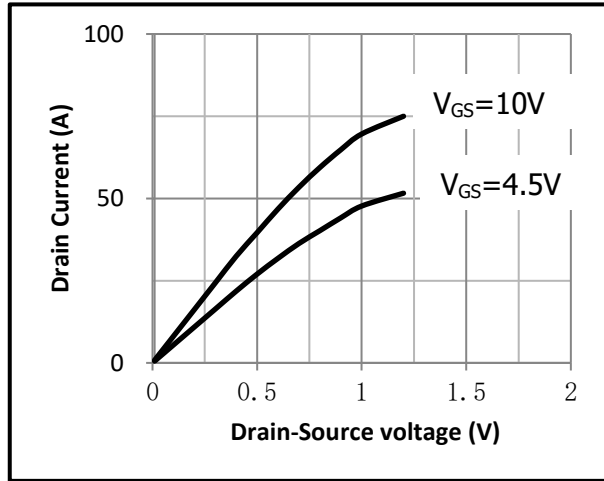

Fig.5 Threshold Voltage V.S Junction Temperature

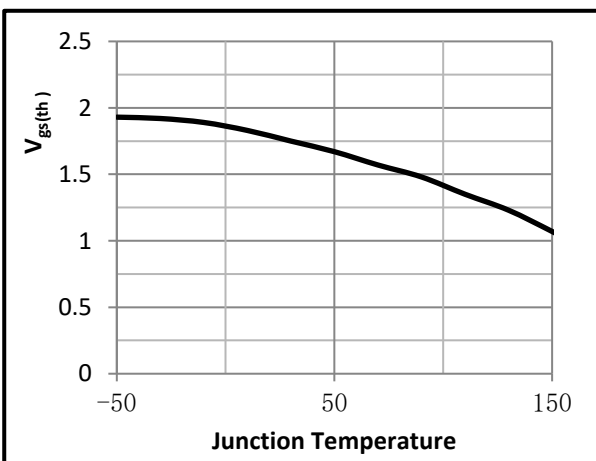

Fig.6 Resistance V.S Drain Current

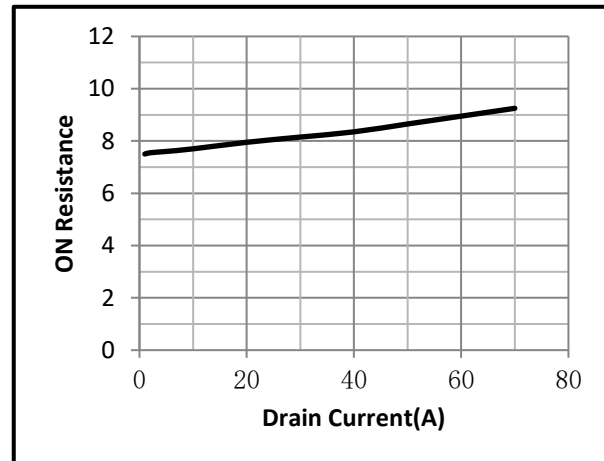

Fig.7 On-Resistance VS Gate Source Voltage

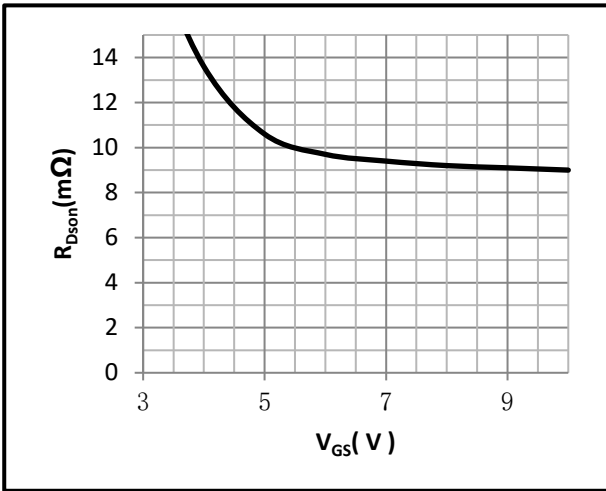

Fig.8 On-Resistance V.S Junction Temperature

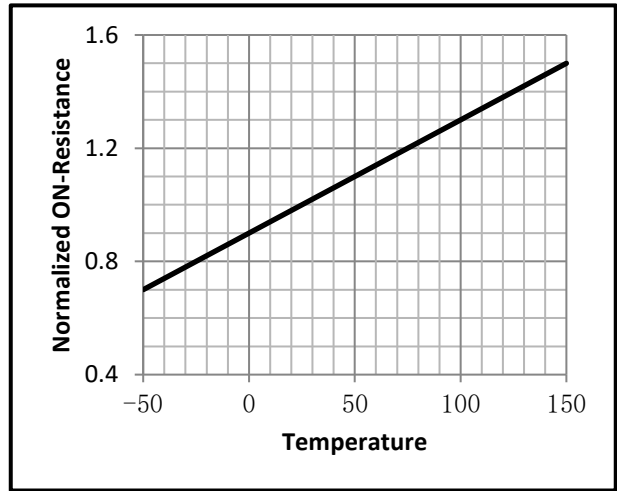

Fig.9 Switching Time Measurement Circuit

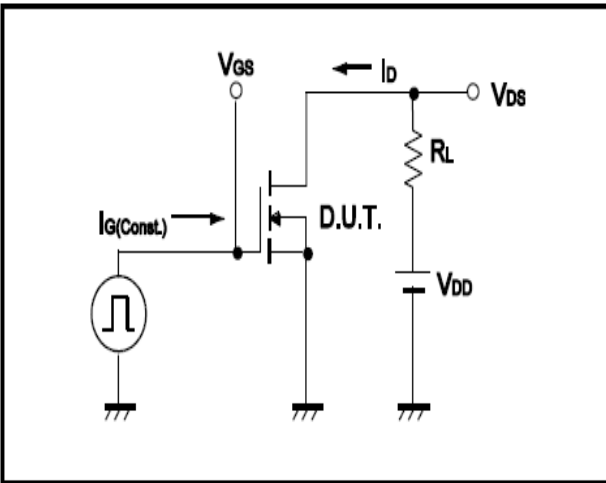

Fig.10 Gate Charge Waveform

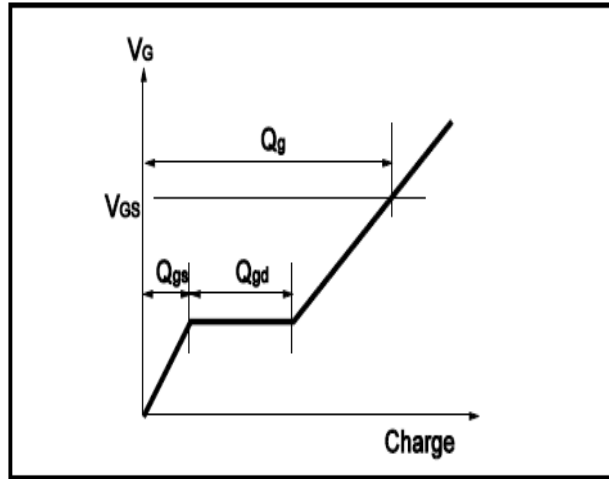

Fig.11 Switching Time Measurement Circuit

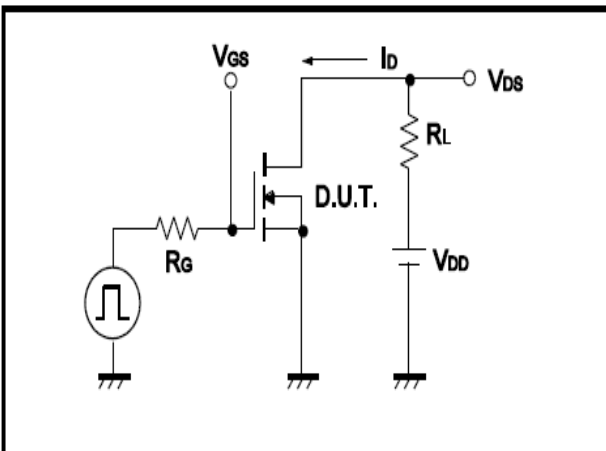
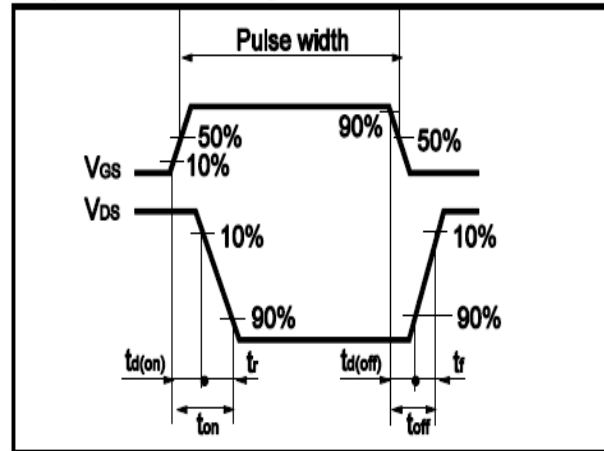

Fig.12 Gate Charge Waveform





•Dimensions (DFN5x6)

Unit: mm

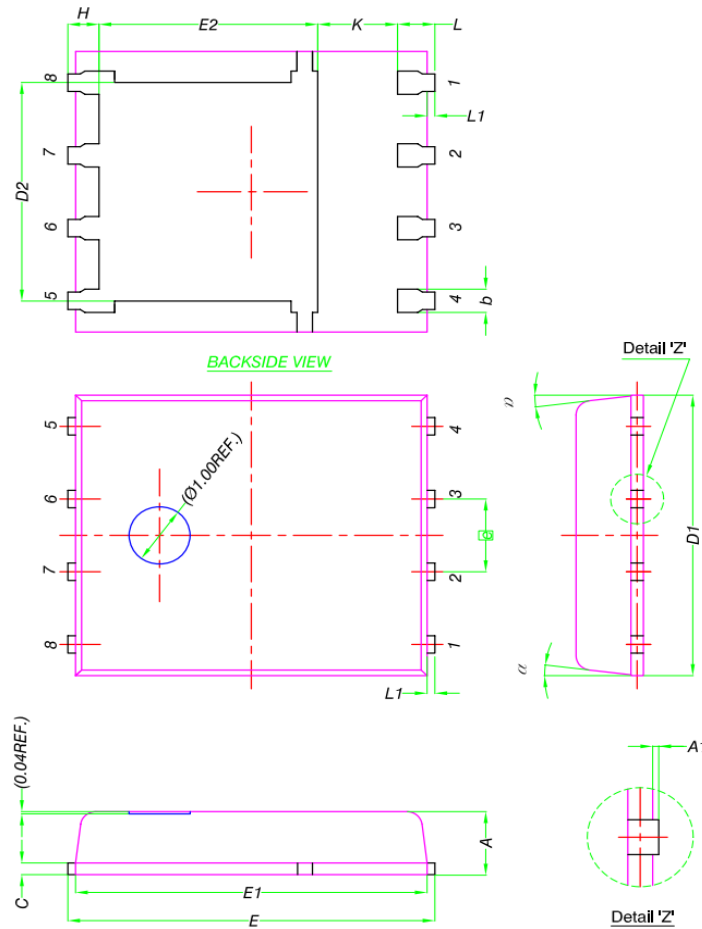

DIM.	MILLIMETERS		
	MIN.	NOM.	MAX.
A	0.90	1.00	1.10
A1	0	-	0.05
b	0.33	0.41	0.51
C	0.20	0.25	0.30
D1	4.80	4.90	5.00
D2	3.61	3.81	3.96
E	5.90	6.00	6.10
E1	5.70	5.75	5.80
E2	3.38	3.58	3.78
e	1.27 BSC		
H	0.41	0.51	0.61
K	1.10	-	-
L	0.51	0.61	0.71
L1	0.06	0.13	0.20
α	0°	-	12°