

**• General Description**

It combines advanced trench MOSFET technology with a low resistance package to provide extremely low  $R_{DS(ON)}$ .

**• Features**

- Advance device constructure
- Low  $R_{DS(ON)}$  to minimize conduction loss
- Low Gate Charge for fast switching
- Low Thermal resistance

**• Application**

- Synchronous Rectification for AC-DC/DC-DC converter
- Power Tools

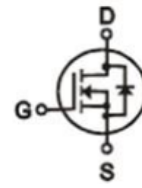
**• Product Summary**

$V_{DS} = 120V$

$R_{DS(ON)} = 12m\Omega$

$I_D = 80A$

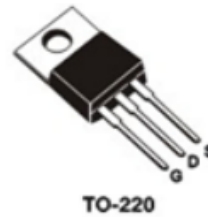
**• Ordering Information:**

Part NO.	ZMS110N12P
Marking	ZMS110N12
Packing Information	Bulk Tube
Basic ordering unit (pcs)	500

**• Absolute Maximum Ratings (T<sub>c</sub> =25°C)**

Parameter	Symbol	Rating	Unit
Drain-Source Voltage	$V_{DS}$	120	V
Gate-Source Voltage	$V_{GS}$	±20	V
Continuous Drain Current	$I_D@TC=25^\circ C$	80	A
	$I_D@TC=75^\circ C$	60	A
	$I_D@TC=100^\circ C$	50	A
Pulsed Drain Current ①	$I_{DM}$	240	A
Total Power Dissipation(TC=25°C)	$P_D@TC=25^\circ C$	125	W
Operating Junction Temperature	$T_J$	-55 to 150	°C
Storage Temperature	$T_{STG}$	-55 to 150	°C
Single Pulse Avalanche Energy@L=0.1mH	$E_{AS}$	80	mJ
Avalanche Current@L=0.1mH	$I_{AS}$	40	A

**•Thermal resistance**

Parameter	Symbol	Min.	Typ.	Max.	Unit
Thermal resistance, junction - case	R <sub>thJC</sub>	-	-	1.0	° C/W
Thermal resistance, junction - ambient	R <sub>thJA</sub>	-	-	50	° C/W
Soldering temperature, wavesoldering for 10s	T <sub>sold</sub>	-	-	265	° C

**•Electronic Characteristics**

Parameter	Symbol	Condition	Min.	Typ	Max.	Unit
Drain-Source Breakdown Voltage	BV <sub>DSS</sub>	V <sub>GS</sub> = 0V, I <sub>D</sub> = 250uA	110			V
Gate Threshold Voltage	V <sub>GS(TH)</sub>	V <sub>GS</sub> = V <sub>DS</sub> , I <sub>D</sub> = 250uA	1.3	1.7	2.5	V
Drain-Source Leakage Current	I <sub>DSS</sub>	V <sub>DS</sub> = 100V, V <sub>GS</sub> = 0V			1.0	uA
Gate- Source Leakage Current	I <sub>GSS</sub>	V <sub>GS</sub> = ±20V, V <sub>DS</sub> = 0V			±100	nA
Static Drain-source On Resistance	R <sub>DS(ON)</sub>	V <sub>GS</sub> = 10V, I <sub>D</sub> = 30A		12	15	mΩ
		V <sub>GS</sub> = 4.5V, I <sub>D</sub> = 20A		14	18	mΩ
Forward Transconductance	g <sub>FS</sub>	V <sub>DS</sub> = 10V, I <sub>D</sub> = 40A		18		s
Diode Forward Voltage	V <sub>FSD</sub>	I <sub>S</sub> = 30A			1.2	V

**•Electronic Characteristics**

Parameter	Symbol	Condition	Min.	Typ	Max.	Unit
Input capacitance	C <sub>iss</sub>	f = 1MHz	-	2420	-	pF
Output capacitance	C <sub>oss</sub>		-	960	-	
Reverse transfer capacitance	C <sub>rss</sub>		-	54	-	

**•Switching Parameters (T<sub>a</sub> = 25°C)**

Parameter	Symbol	Condition	Min.	Typ	Max.	Unit
Total gate charge	Q <sub>g</sub>	V <sub>DD</sub> = 30V I <sub>D</sub> = 10A V <sub>GS</sub> = 10V	-	28	-	nC
Gate - Source charge	Q <sub>gs</sub>		-	3.8	-	
Gate - Drain charge	Q <sub>gd</sub>		-	5.9	-	
Turn-ON Delay time	t <sub>D(on)</sub>	V <sub>GS</sub> = 10V, V <sub>DS</sub> = 50V, R = 0.75Ω, R = 6Ω		15		nS
Turn-ON Rise time	t <sub>r</sub>			17		
Turn-Off Delay time	t <sub>D(off)</sub>			96		

Turn-Off Fall time	$t_f$		76	
Body Diode Reverse Recovery Time	$t_{rr}$	IF=20A, dI/dt=100A/μs	47	nS
Body Diode Reverse Recovery Charge	$Q_{rr}$	IF=20A, dI/dt=100A/μs	38	nC

Note: ① Pulse Test : Pulse width ≤ 10μs, Duty cycle ≤ 1% ;

Fig.1 Gate-Charge Characteristics

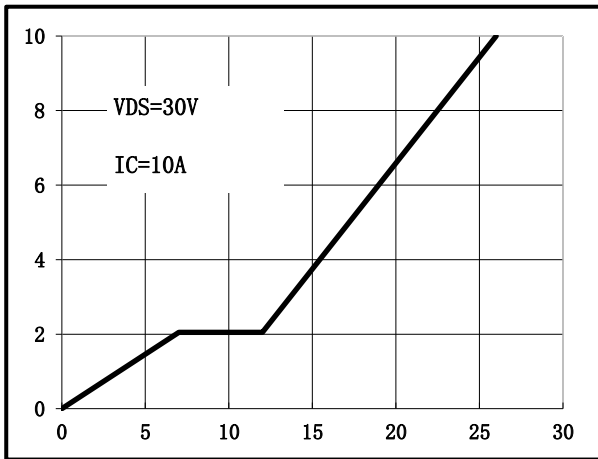

Fig.2 Capacitance Characteristics

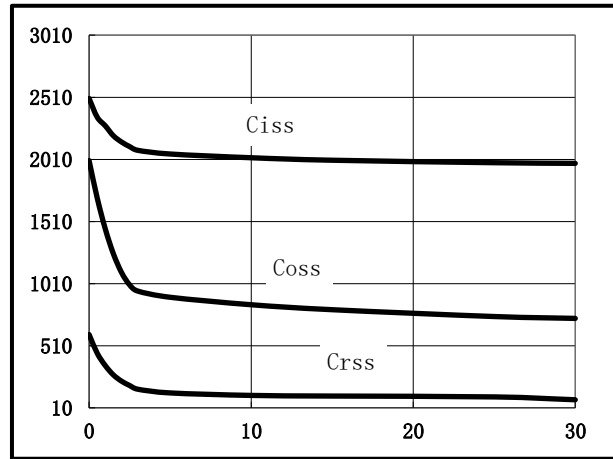

Fig.3 Power Dissipation

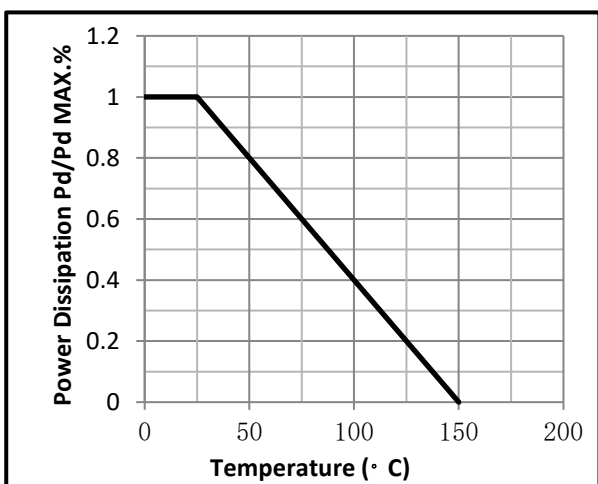

Fig.4 Typical output Characteristics

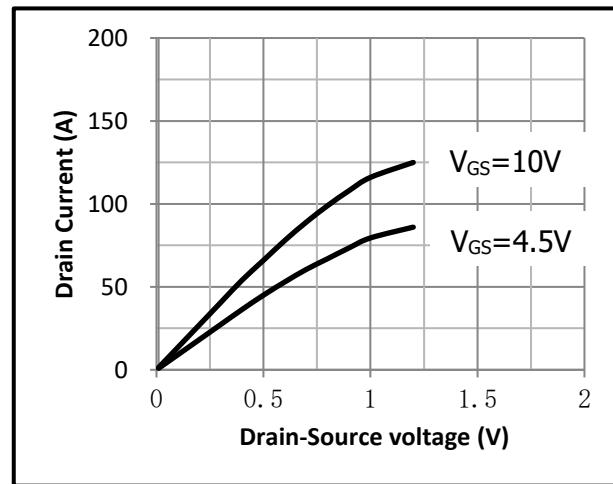

Fig.5 Threshold Voltage V.S Junction Temperature

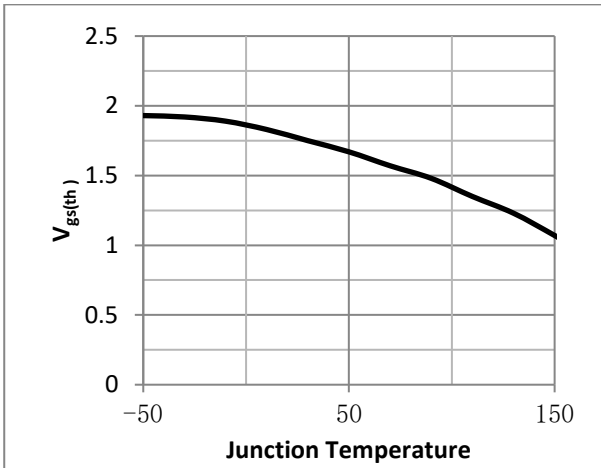

Fig.6 Resistance V.S Drain Current

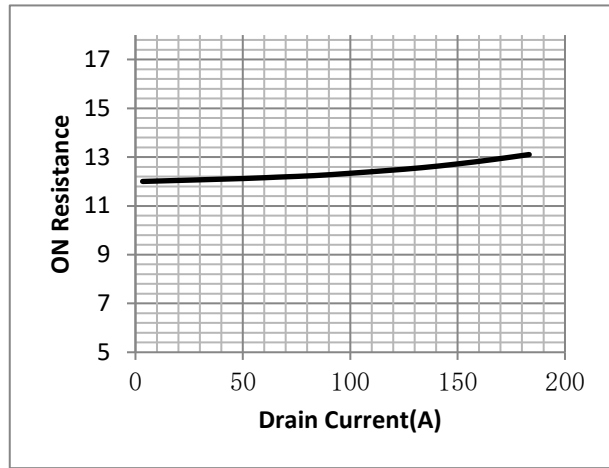

Fig.7 On-Resistance VS Gate Source Voltage

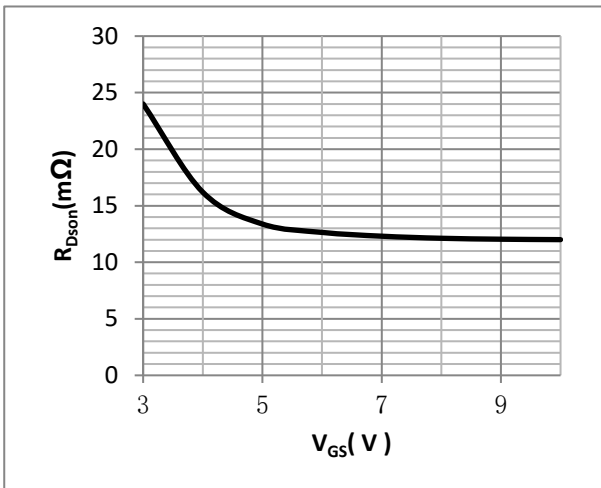

Fig.8 On-Resistance V.S Junction Temperature

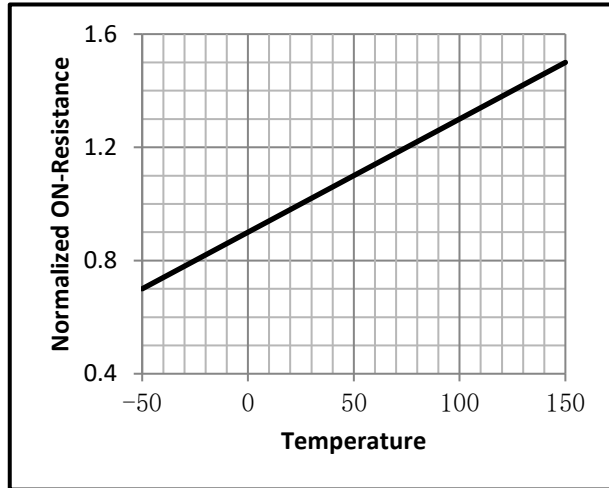

Fig.9 Switching Time Measurement Circuit

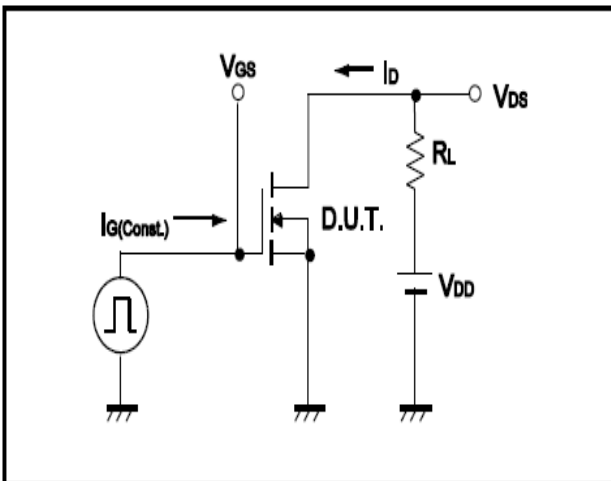

Fig.10 Gate Charge Waveform

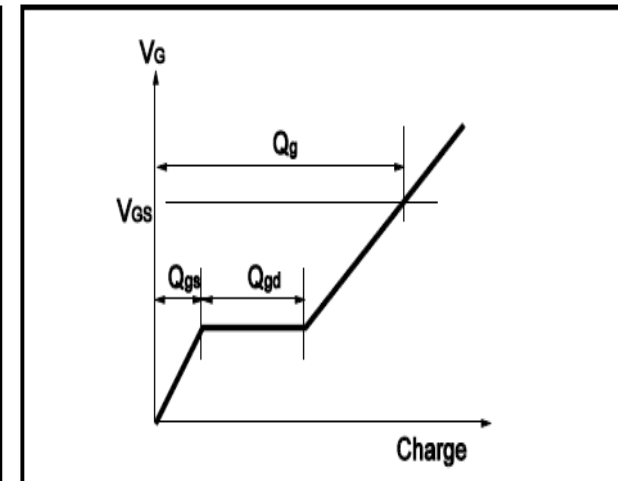

Fig.11 Switching Time Measurement Circuit

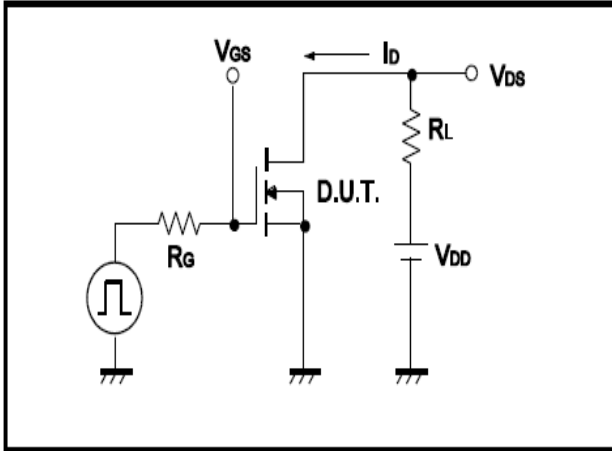
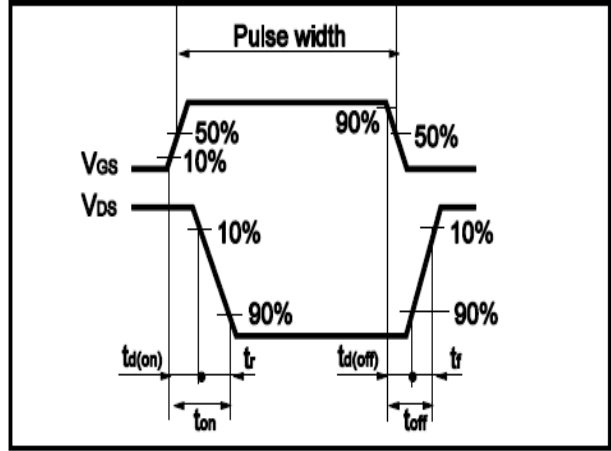

Fig.12 Gate Charge Waveform





• Dimensions (TO-220)

Unit: mm

SYMBOL	min	nom	max	SYMBOL	min	nom	max
A	4.00		4.80	E	9.90		10.70
B	1.20		1.50	e		2.54	
B1	1.00		1.40	F	1.10		1.45
b1	0.65		1.00	L	12.50		14.50
c	0.35		0.75	L1	3.00	3.50	4.00
D	15.00		16.50	Q	2.50		3.00
D1	5.90		6.90	Q1	2.00		3.00
				ΦP	3.60		3.90

