

**• General Description**

The ZMS075N10S combines advanced trench MOSFET technology with a low resistance package to provide extremely low  $R_{DS(ON)}$ .

**• Features**

- Advance device constructure
- Low  $R_{DS(ON)}$  to minimize conduction loss
- Low Gate Charge for fast switching
- Low Thermal resistance

**• Application**

- Synchronous Rectification for AC-DC/DC-DC converter
- Oring switches
- Power Tools

**• Ordering Information:**

Part NO.	ZMS075N10S
Marking	ZMS075N10
Packing Information	REEL TAPE
Basic ordering unit (pcs)	4000

**• Absolute Maximum Ratings ( $T_C = 25^\circ\text{C}$ )**

Parameter	Symbol	Rating	Unit
Drain-Source Voltage	$V_{DS}$	100	V
Gate-Source Voltage	$V_{GS}$	$\pm 20$	V
Continuous Drain Current	$I_{D@TC=25^\circ\text{C}}$	15	A
	$I_{D@TC=75^\circ\text{C}}$	11.4	A
	$I_{D@TC=100^\circ\text{C}}$	9.4	A
Pulsed Drain Current ①	$I_{DM}$	32	A
Total Power Dissipation	$P_D@TC=25^\circ\text{C}$	3.6	W
Total Power Dissipation	$P_D@TA=25^\circ\text{C}$	0.69	W
Operating Junction Temperature	$T_J$	-55 to 150	$^\circ\text{C}$
Storage Temperature	$T_{STG}$	-55 to 150	$^\circ\text{C}$
Single Pulse Avalanche Energy	$E_{AS}$	50	mJ

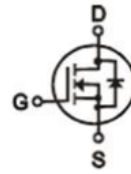
**• Product Summary**

$V_{DS} = 100\text{V}$

$R_{DS(ON)} = 7.5\text{m}\Omega$

$I_D = 15\text{A}$

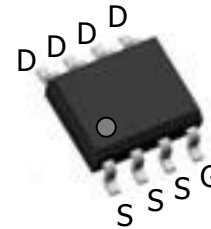

**•Thermal resistance**

Parameter	Symbol	Min.	Typ.	Max.	Unit
Thermal resistance, junction - case	R <sub>thJC</sub>	-	-	34	° C/W
Thermal resistance, junction - ambient	R <sub>thJA</sub>	-	-	180	° C/W
Soldering temperature, wavesoldering for 10s	T <sub>sold</sub>	-	-	265	° C

**•Electronic Characteristics**

Parameter	Symbol	Condition	Min.	Typ	Max.	Unit
Drain-Source Breakdown Voltage	BV <sub>DSS</sub>	V <sub>GS</sub> = 0V, I <sub>D</sub> = 250uA	100			V
Gate Threshold Voltage	V <sub>GS(TH)</sub>	V <sub>GS</sub> = V <sub>DS</sub> , I <sub>D</sub> = 250uA	1.6		2.5	V
Drain-Source Leakage Current	I <sub>DSS</sub>	V <sub>DS</sub> = 100V, V <sub>GS</sub> = 0V			1.0	uA
Gate- Source Leakage Current	I <sub>GSS</sub>	V <sub>GS</sub> = ±20V, V <sub>DS</sub> = 0V			±100	nA
Static Drain-source On Resistance	R <sub>DS(ON)</sub>	V <sub>GS</sub> = 10V, I <sub>D</sub> = 15A		7.5	9.5	mΩ
		V <sub>GS</sub> = 4.5V, I <sub>D</sub> = 10A		9.5	11.5	mΩ
Forward Transconductance	g <sub>FS</sub>	V <sub>DS</sub> = 25V, I <sub>D</sub> = 10A		16		s
Diode Forward Voltage	V <sub>FSD</sub>	I <sub>S</sub> = 15A			1.2	V

**•Electronic Characteristics**

Parameter	Symbol	Condition	Min.	Typ	Max.	Unit
Input capacitance	C <sub>iss</sub>	f = 1MHz	-	2120	-	pF
Output capacitance	C <sub>oss</sub>		-	940	-	
Reverse transfer capacitance	C <sub>rss</sub>		-	48	-	

**•Switching Parameters(T<sub>a</sub> = 25°C)**

Parameter	Symbol	Condition	Min.	Typ	Max.	Unit
Total gate charge	Q <sub>g</sub>	V <sub>DD</sub> = 25V	-	28	-	nC
Gate - Source charge	Q <sub>gs</sub>	I <sub>D</sub> = 8A	-	5.5	-	
Gate - Drain charge	Q <sub>gd</sub>	V <sub>GS</sub> = 10V	-	5.3	-	
Body Diode Reverse Recovery Time	t <sub>rr</sub>	I <sub>F</sub> = 20A, di/dt = 100A/μs		47		nS
Body Diode Reverse Recovery Charge	Q <sub>rr</sub>	I <sub>F</sub> = 20A, di/dt = 100A/μs		38		nC

Note: ① Pulse Test : Pulse width ≤ 300μs, Duty cycle ≤ 2% ;

Fig.1 Gate-Charge Characteristics

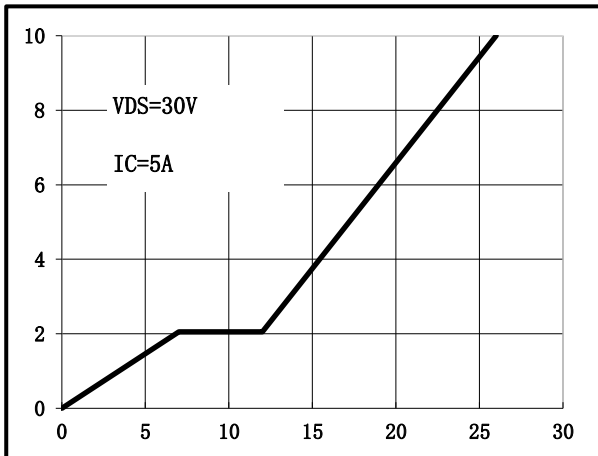

Fig.2 Capacitance Characteristics

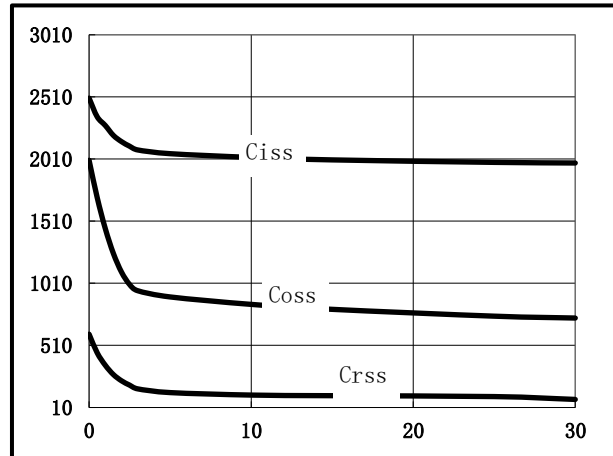

Fig.3 Power Dissipation

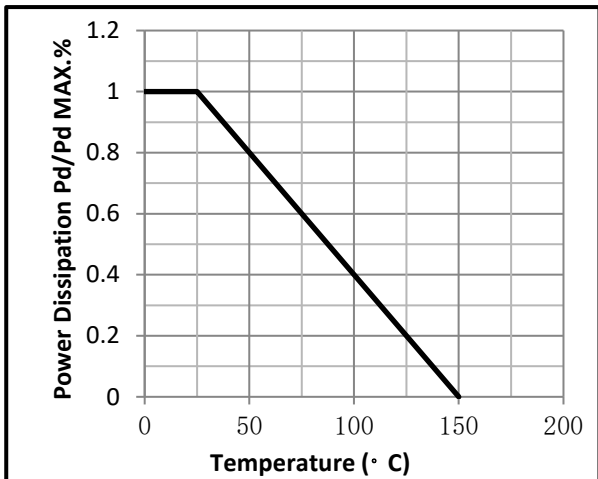

Fig.4 Typical output Characteristics

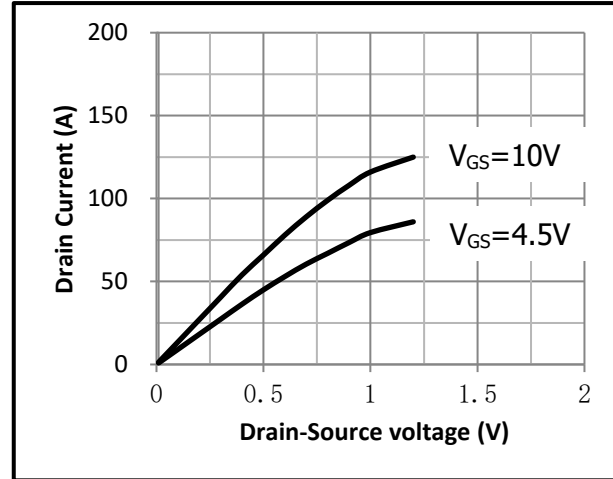

Fig.5 Threshold Voltage V.S Junction Temperature

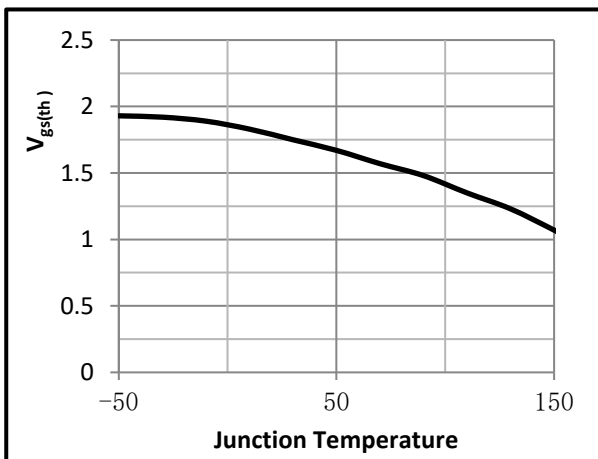

Fig.6 Resistance V.S Drain Current

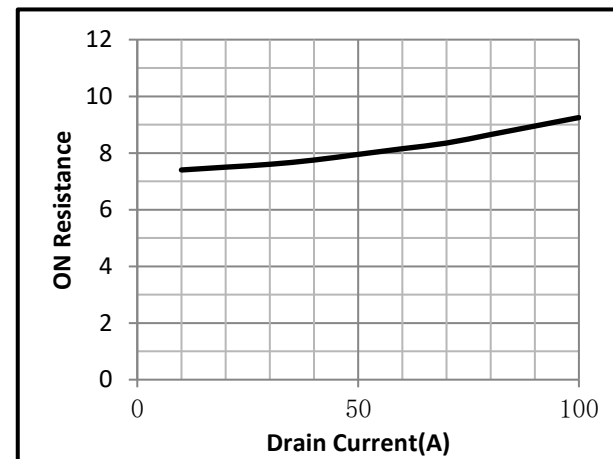

Fig.7 On-Resistance VS Gate Source Voltage

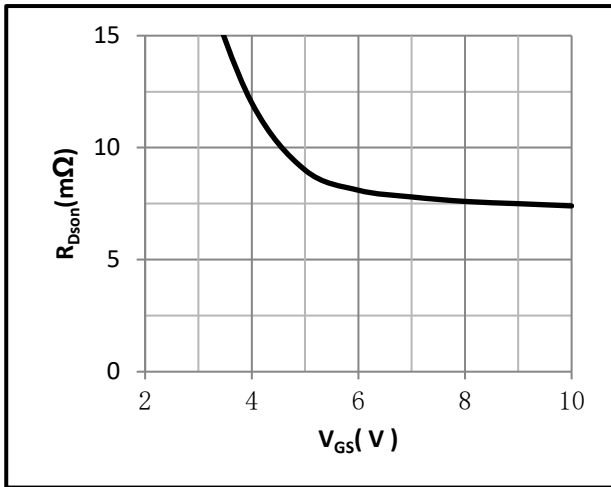

Fig.8 On-Resistance V.S Junction Temperature

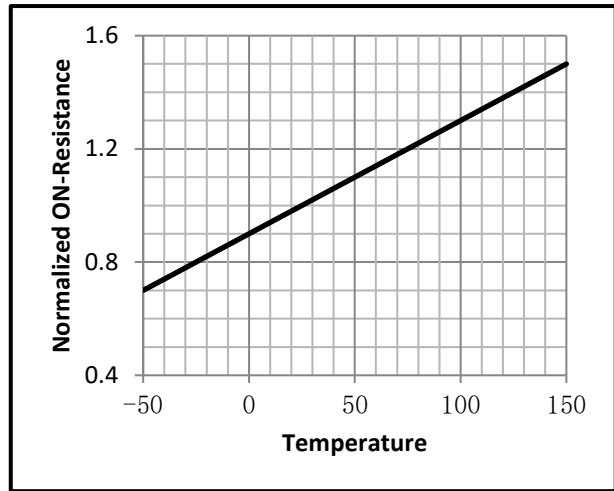

Fig.9 Switching Time Measurement Circuit

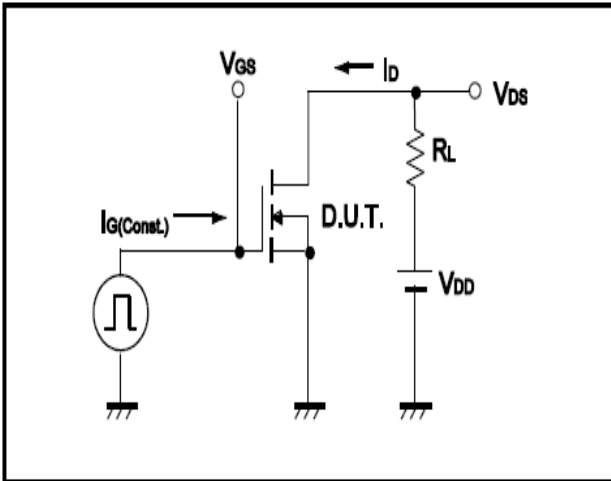

Fig.10 Gate Charge Waveform

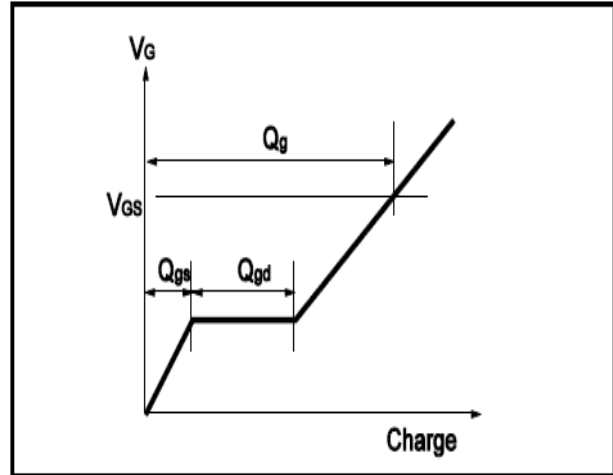

Fig.11 Switching Time Measurement Circuit

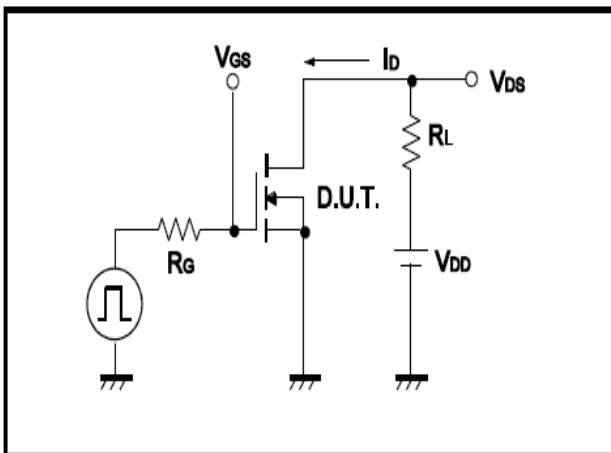
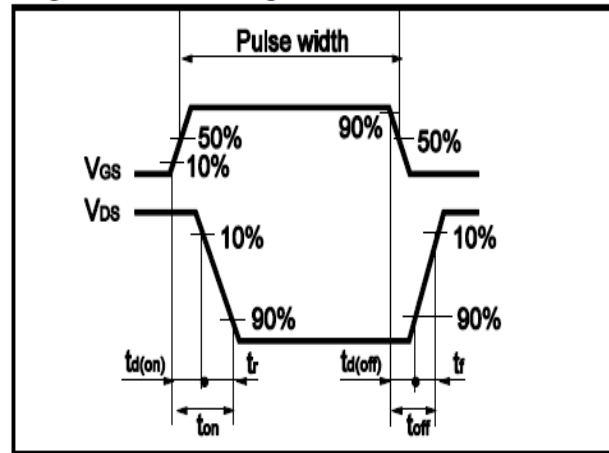

Fig.12 Gate Charge Waveform



●Dimensions(SOP8)

Unit: mm

SYMBOL	min	TYP	max	SYMBOL	min		max
A	4.80		5.25	C	1.30		1.75
A1	0.37		0.49	C1	0.55		0.75
A2		1.27		C2	0.55		0.65
A3		0.41		C3	0.05		0.20
B	5.80		6.20	C4	0.10	0.20	0.23
B1	3.80		4.10	D		1.05	
B2		5.00		D1	0.40		0.62

