

• General Description

The ZM075P03M combines advanced trench MOSFET technology with a low resistance package to provide extremely low $R_{DS(ON)}$.

• Features

- Advance high cell density Trench technology
- Low $R_{DS(ON)}$ to minimize conductive loss
- Low Gate Charge for fast switching
- Low Thermal resistance

• Application

- MB/VGA Vcore
- SMPS 2nd Synchronous Rectifier
- POL application
- BLDC Motor driver

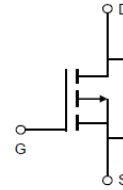
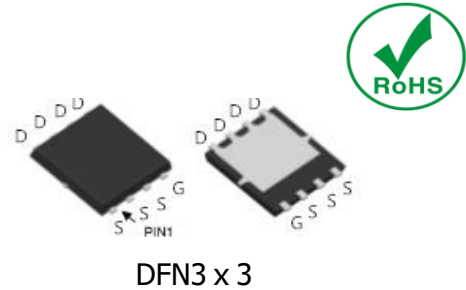
• Product Summary

 $V_{DS} = -30V$
 $R_{DS(ON)} = 7.5m\Omega$
 $I_D = -50A$

• Ordering Information:

Part NO.	ZM075P03M
Marking	075P03
Packing Information	REEL TAPE
Basic ordering unit (pcs)	5000

• Absolute Maximum Ratings ($T_C = 25^\circ C$)

Parameter	Symbol	Rating	Unit
Drain-Source Voltage	V_{DS}	-30	V
Gate-Source Voltage	V_{GS}	± 20	V
Continuous Drain Current	$I_D @ T_C = 25^\circ C$	-50	A
	$I_D @ T_C = 75^\circ C$	-38	A
	$I_D @ T_C = 100^\circ C$	-31.5	A
Pulsed Drain Current ^①	I_{DM}	-130	A
Total Power Dissipation	$P_D @ T_C = 25^\circ C$	46	W
Total Power Dissipation	$P_D @ T_A = 25^\circ C$	2.3	W
Operating Junction Temperature	T_J	-55 to 150	$^\circ C$
Storage Temperature	T_{STG}	-55 to 150	$^\circ C$
Single Pulse Avalanche Energy @ $L = 0.1mH$	E_{AS}	180	mJ
Avalanche Current @ $L = 0.1mH$	I_{AS}	60	A

•Thermal resistance

Parameter	Symbol	Min.	Typ.	Max.	Unit
Thermal resistance, junction - case	R_{thJC}	-	-	2.7	$^{\circ}C/W$
Thermal resistance, junction - ambient	R_{thJA}	-	-	53	$^{\circ}C/W$
Soldering temperature, wavesoldering for 10s	T_{sold}	-	-	265	$^{\circ}C$

•Electronic Characteristics

Parameter	Symbol	Condition	Min.	Typ	Max.	Unit
Drain-Source Breakdown Voltage	BV_{DSS}	$V_{GS}=0V, I_D=-250\mu A$	-30			V
Gate Threshold Voltage	$V_{GS(TH)}$	$V_{GS}=V_{DS}, I_D=-250\mu A$	-1.2	-1.9	-2.5	V
Drain-Source Leakage Current	I_{DSS}	$V_{DS}=-30V, V_{GS}=0V$			-1.0	μA
Gate- Source Leakage Current	I_{GSS}	$V_{GS}=\pm 20V, V_{DS}=0V$			± 100	nA
Static Drain-source On Resistance	$R_{DS(ON)}$	$V_{GS}=-10V, I_D=-20A$		7.5	8.5	$m\Omega$
		$V_{GS}=-4.5V, I_D=-10A$		11.5	14	$m\Omega$
Forward Transconductance	g_{FS}	$V_{DS}=-10V, I_D=-5A$		10		S
Source-drain voltage	V_{SD}	$I_S=-20A$			1.28	V

•Electronic Characteristics

Parameter	Symbol	Condition	Min.	Typ	Max.	Unit
Input capacitance	C_{iss}	$V_{GS}=0V, V_{DS}=-25V$ $f = 1MHz$	-	2800	-	pF
Output capacitance	C_{oss}		-	420	-	
Reverse transfer capacitance	C_{rss}		-	280	-	

•Switching Parameters($T_a = 25^{\circ}C$)

Parameter	Symbol	Condition	Min.	Typ	Max.	Unit
Total gate charge	Q_g	$V_{DD}=-25V$	-	27	-	nC
Gate - Source charge	Q_{gs}	$I_D=-8A$	-	8.6	-	
Gate - Drain charge	Q_{gd}	$V_{GS}=-10V$	-	13.8	-	
Body Diode Reverse Recovery Time	t_{rr}	$I_F=20A,$ $di/dt=100A/\mu s$		22		nS
Body Diode Reverse Recovery Charge	Q_{rr}	$I_F=20A,$ $di/dt=100A/\mu s$		105		nC

Note: ① Pulse Test : Pulse width $\leq 300\mu s$, Duty cycle $\leq 2\%$;

② Device mounted on FR-4 substrate PC board, 2oz copper, with thermal bias to bottom layer 1inch square copper plate;

Fig.1 Power Dissipation Derating Curve

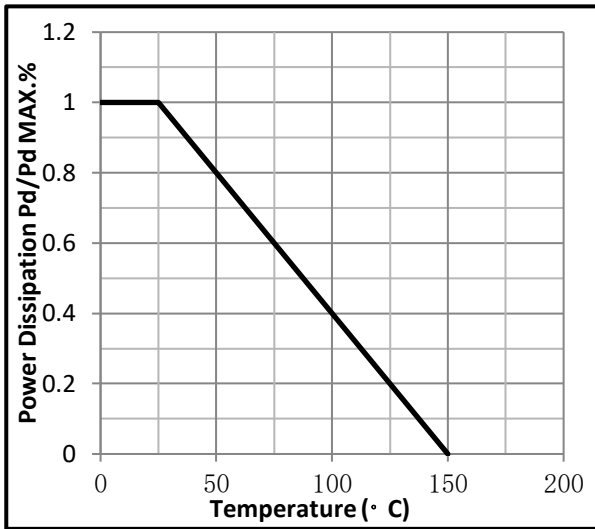

Fig.2 Typical output Characteristics

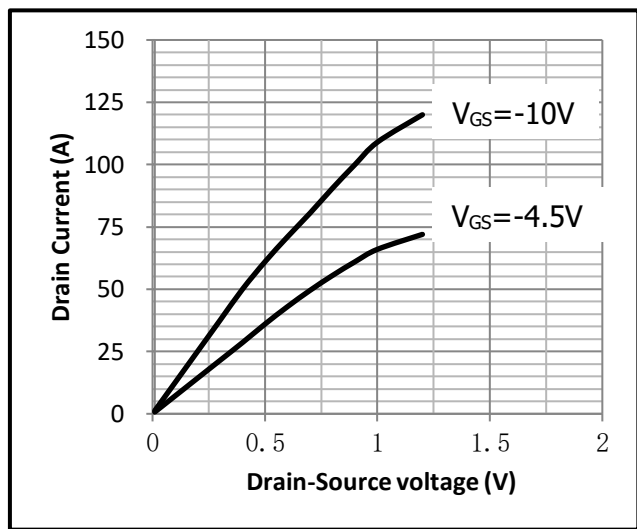

Fig.3 Threshold Voltage V.S Junction Temperature

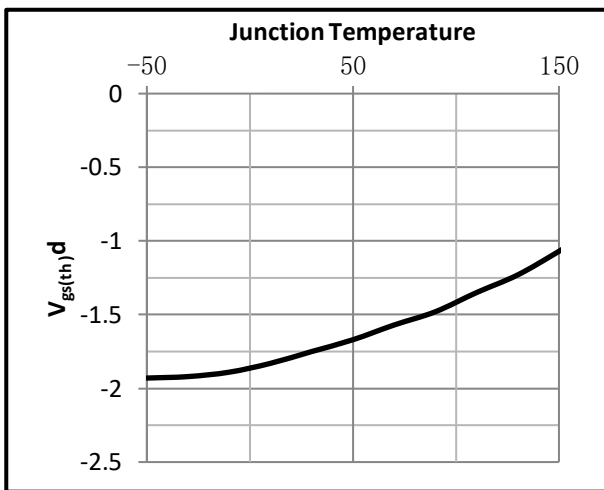

Fig.4 Resistance V.S Drain Current

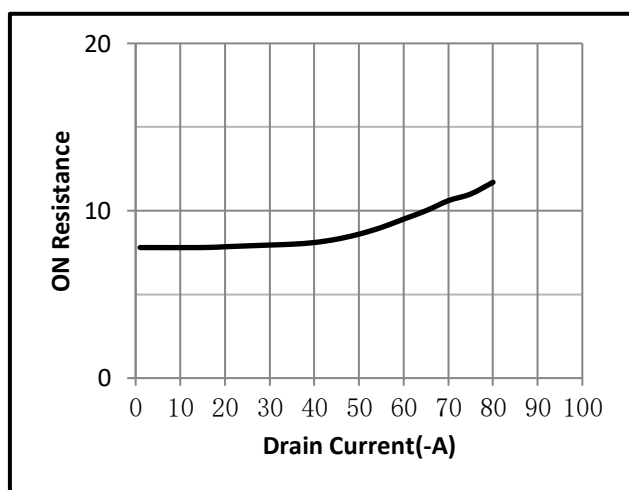

Fig.5 On-Resistance VS Gate Source Voltage

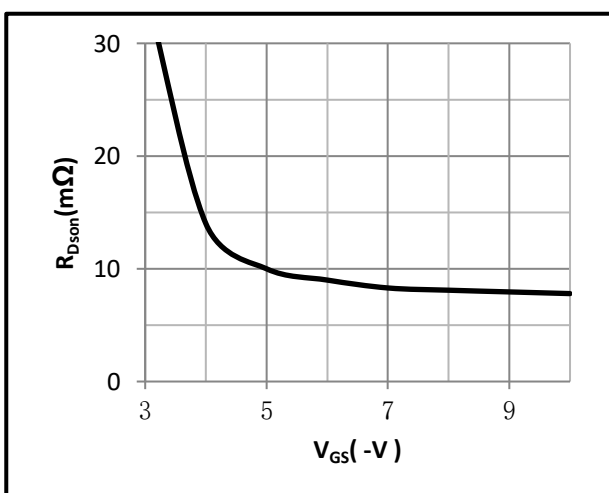

Fig.6 On-Resistance V.S Junction Temperature

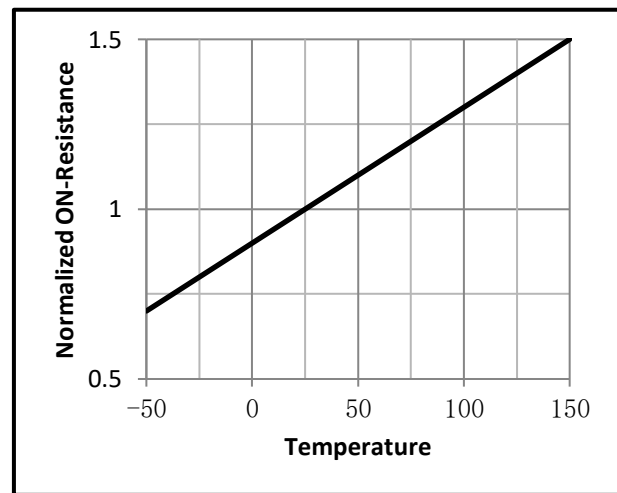

Fig.7 Gate-Charge Characteristics

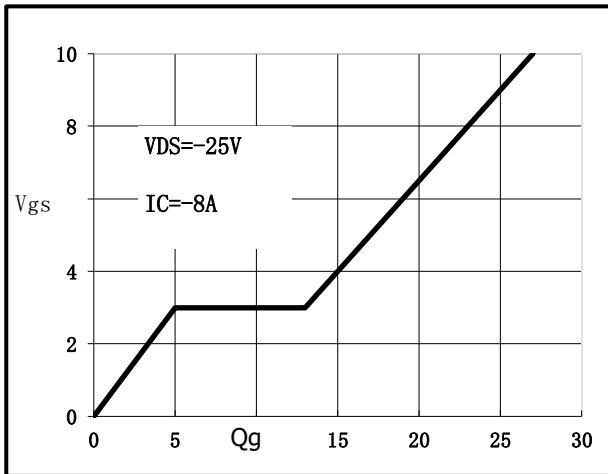

Fig.8 Capacitance Characteristics

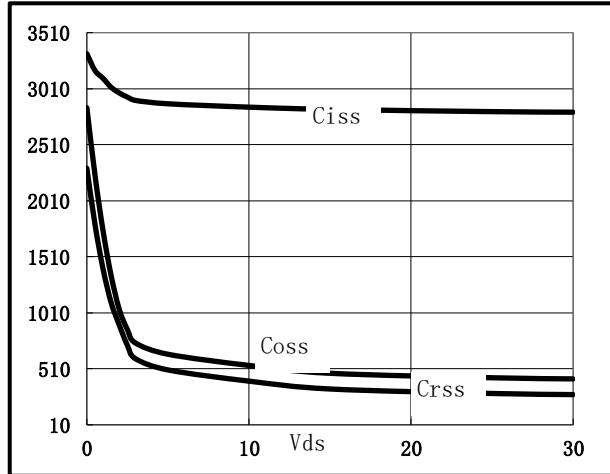

Fig.9 Switching Time Measurement Circuit

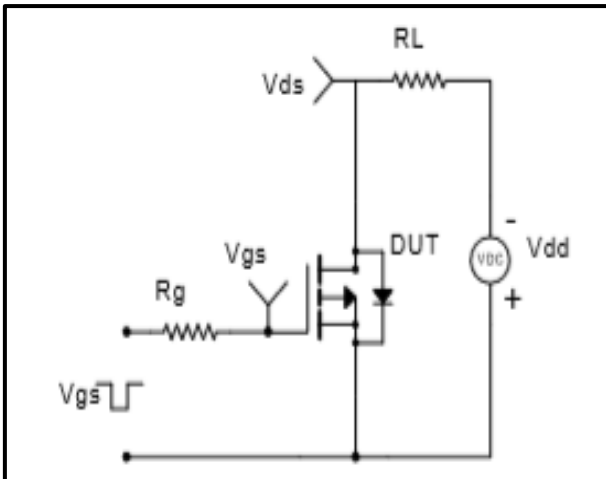

Fig.10 Gate Charge Waveform

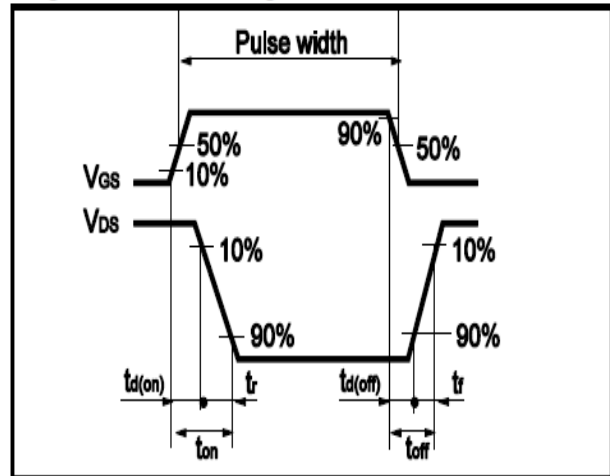

Fig.11 Avalanche Measurement Circuit

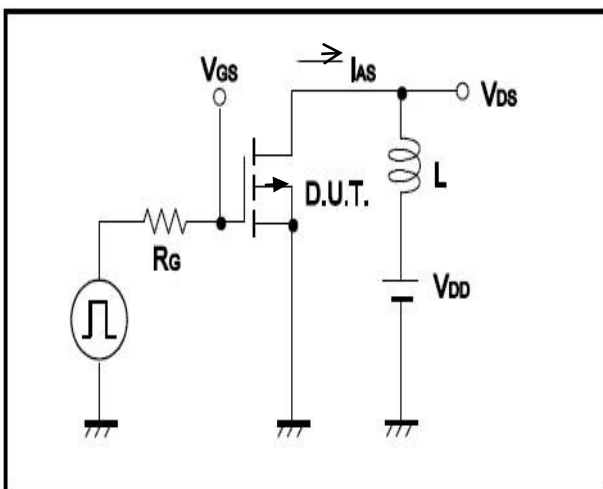
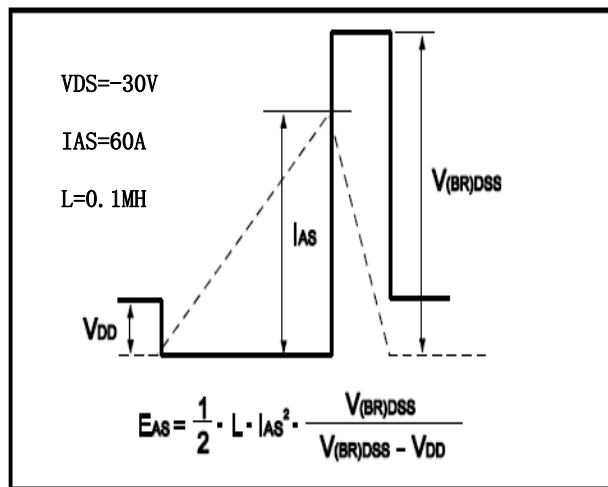

Fig.12 Avalanche Waveform





•Dimensions(DFN3×3)

Unit: mm

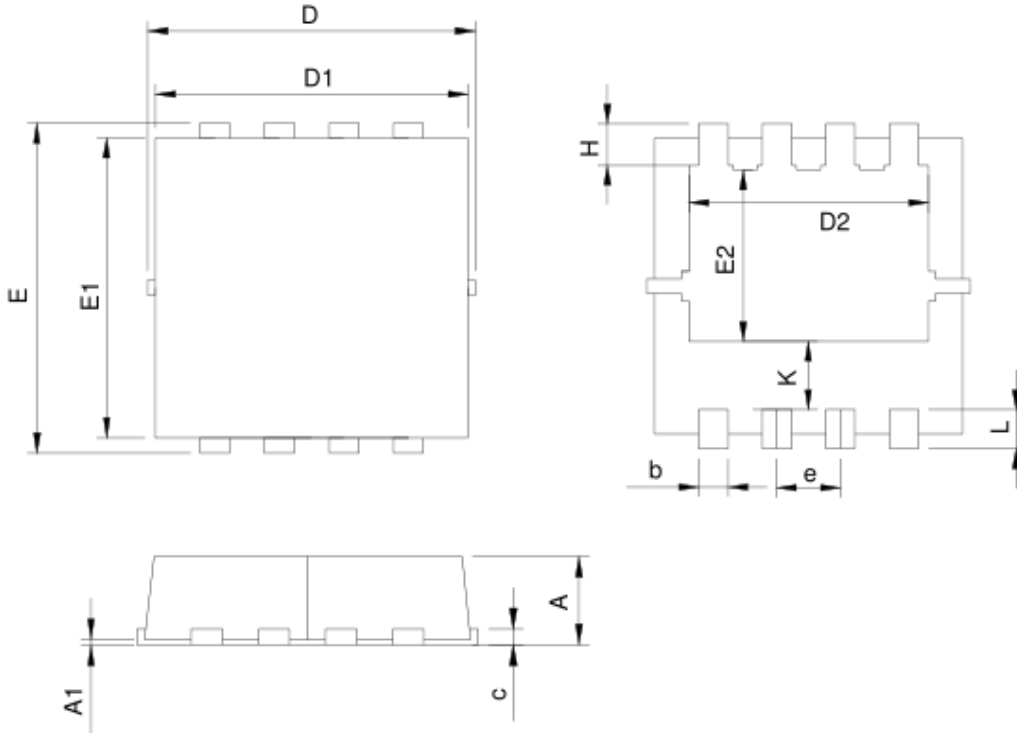

SYMBOL	DFN3.3x3.3-8			
	MILLIMETERS		INCHES	
	MIN.	MAX.	MIN.	MAX.
A	0.70	1.00	0.028	0.039
A1	0.00	0.05	0.000	0.002
b	0.25	0.35	0.010	0.014
c	0.14	0.20	0.006	0.008
D	3.10	3.50	0.122	0.138
D1	3.05	3.25	0.120	0.128
D2	2.35	2.55	0.093	0.100
E	3.10	3.50	0.122	0.138
E1	2.90	3.10	0.114	0.122
E2	1.64	1.84	0.065	0.072
e	0.65 BSC		0.026 BSC	
H	0.32	0.52	0.013	0.020
K	0.59	0.79	0.023	0.031
L	0.25	0.55	0.010	0.022

RECOMMENDED LAND PATTERN

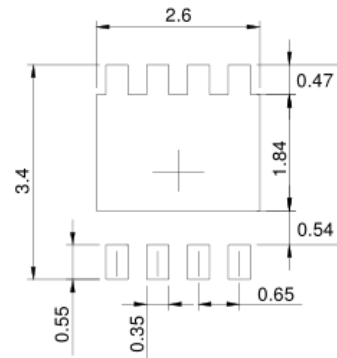

UNIT: mm