

• General Description

It combines advanced MOSFET technology with a low resistance package to provide extremely low $R_{DS(ON)}$.

• Features

- Advance device constructure
- Low $R_{DS(ON)}$ to minimize conduction loss
- Low Gate Charge for fast switching
- Low Thermal resistance

• Application

- Synchronous Rectification for AC-DC/DC-DC converter
- Power Tools

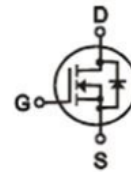
• Product Summary

$V_{DS} = 65V$

$R_{DS(ON)} = 5.2m\Omega$

$I_D = 68A$

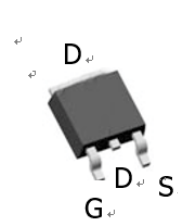

To-252

• Ordering Information:

Part NO.	ZMS052N06D
Marking	ZMS052N06
Packing Information	REEL TAPE
Basic ordering unit (pcs)	2500

• Absolute Maximum Ratings ($T_C = 25^\circ C$)

Parameter	Symbol	Rating	Unit
Drain-Source Voltage	V_{DS}	65	V
Gate-Source Voltage	V_{GS}	± 20	V
Continuous Drain Current	$I_{D@TC=25^\circ C}$	68	A
	$I_{D@TC=75^\circ C}$	52	A
	$I_{D@TC=100^\circ C}$	43	A
Pulsed Drain Current ①	I_{DM}	204	A
Total Power Dissipation	$P_D@TC=25^\circ C$	56	W
Total Power Dissipation	$P_D@TA=25^\circ C$	2.0	W
Operating Junction Temperature	T_J	-55 to 150	$^\circ C$
Storage Temperature	T_{STG}	-55 to 150	$^\circ C$
Single Pulse Avalanche Energy	E_{AS}	148	mJ

•Thermal resistance

Parameter	Symbol	Min.	Typ.	Max.	Unit
Thermal resistance, junction - case	R_{thJC}			2.2	$^{\circ}C/W$
Thermal resistance, junction - ambient	R_{thJA}	-	-	62	$^{\circ}C/W$
Soldering temperature, wavesoldering for 10s	T_{sold}	-	-	265	$^{\circ}C$

•Electronic Characteristics

Parameter	Symbol	Condition	Min.	Typ	Max.	Unit
Drain-Source Breakdown Voltage	BV_{DSS}	$V_{GS} = 0V, I_D = 250\mu A$	65			V
Gate Threshold Voltage	$V_{GS(TH)}$	$V_{GS} = V_{DS}, I_D = 250\mu A$	1.5		2.5	V
Drain-Source Leakage Current	I_{DSS}	$V_{DS} = 0.8 BV_{DSS}, V_{GS} = 0V$			1.0	μA
Gate- Source Leakage Current	I_{GSS}	$V_{GS} = \pm 20V, V_{DS} = 0V$			± 100	nA
Static Drain-source On Resistance	$R_{DS(ON)}$	$V_{GS} = 10V, I_D = 10A$		5.2	6.5	m Ω
		$V_{GS} = 4.5V, I_D = 5A$		6.8	8.5	m Ω
Forward Transconductance	g_{FS}	$V_{DS} = 25V, I_D = 10A$		16		S
Source-drain voltage	V_{SD}	$I_S = 10A$			1.28	V

•Electronic Characteristics

Parameter	Symbol	Condition	Min.	Typ	Max.	Unit
Gate Resistance	R_g	$f = 1MHz$		2.1		Ω
Input capacitance	C_{iss}	$f = 1MHz$ $V_{DS} = 25V$	-	1910	-	pF
Output capacitance	C_{oss}		-	1070	-	
Reverse transfer capacitance	C_{rss}		-	22	-	

•Gate Charge characteristics($T_a = 25^{\circ}C$)

Parameter	Symbol	Condition	Min.	Typ	Max.	Unit
Total gate charge	Q_g	$V_{DD} = 25V$	-	24	-	nC
Gate - Source charge	Q_{gs}	$I_D = 8A$	-	5	-	
Gate - Drain charge	Q_{gd}	$V_{GS} = 10V$	-	3.3	-	

Note: ① Pulse Test : Pulse width $\leq 300\mu\text{s}$, Duty cycle $\leq 2\%$;

Fig.1 Gate-Charge Characteristics

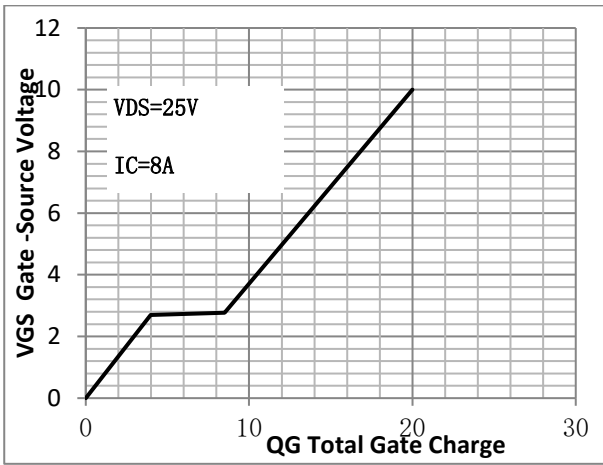

Fig.2 Capacitance Characteristics

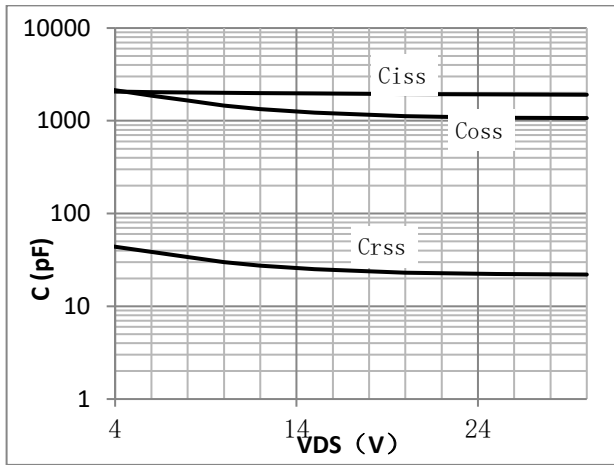

Fig.3 Power Dissipation

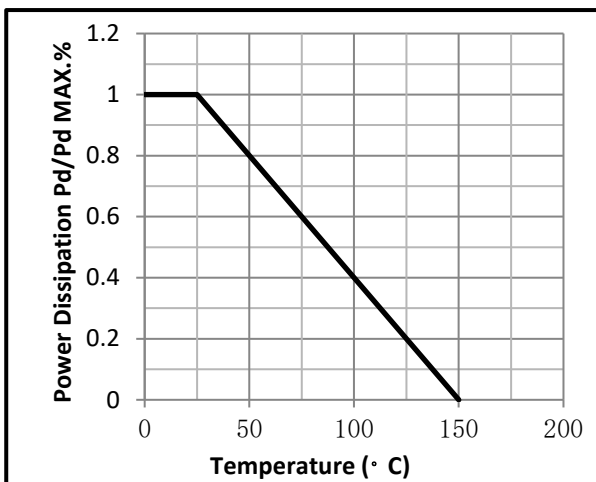

Fig.4 Typical output Characteristics

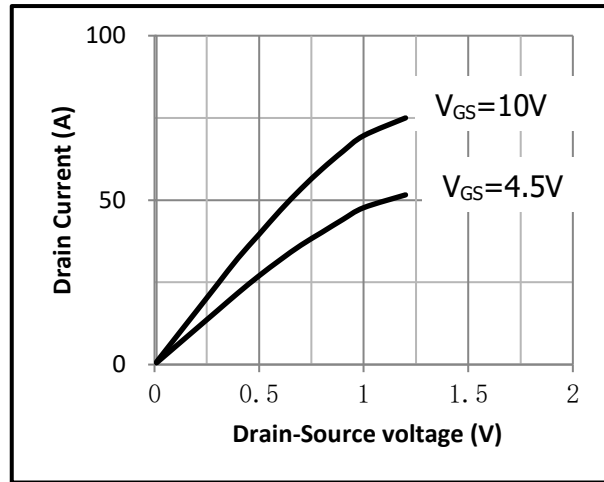

Fig.5 Threshold Voltage V.S Junction Temperature

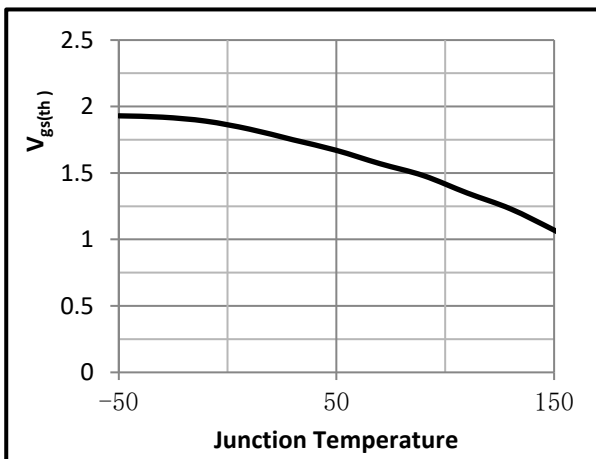

Fig.6 Resistance V.S Drain Current

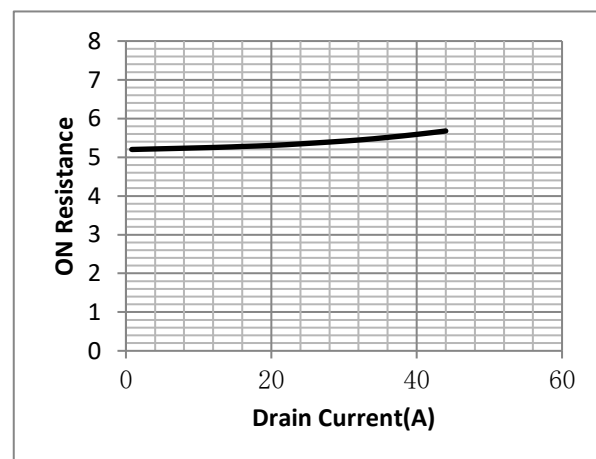

Fig.7 On-Resistance VS Gate Source Voltage

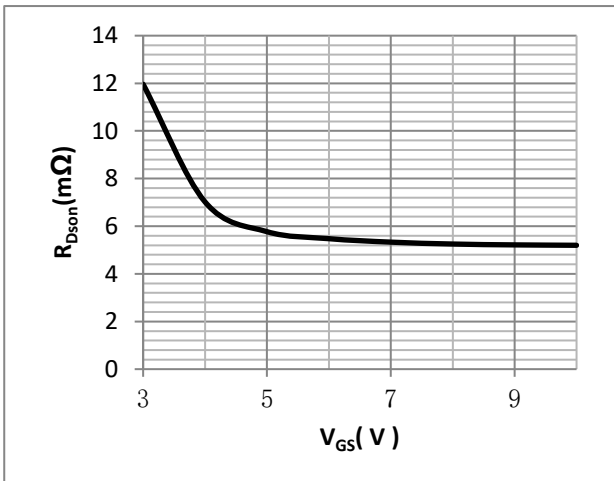

Fig.8 On-Resistance V.S Junction Temperature

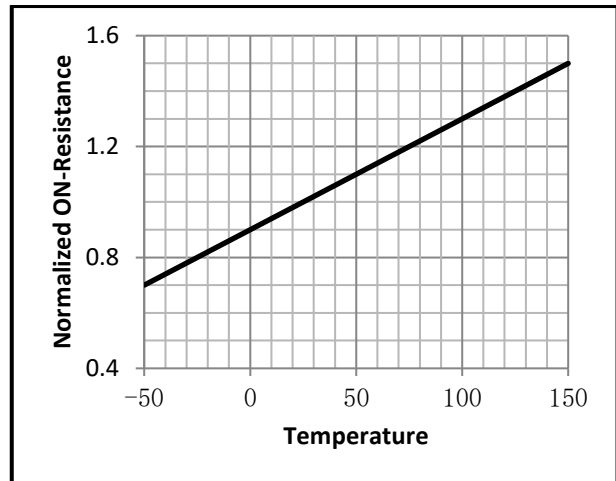

Fig.9 SOA Maximum Safe Operating Area

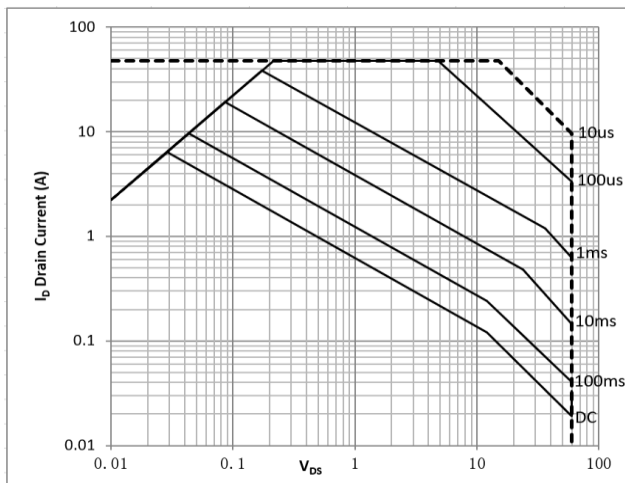

Fig.10 ID-Junction Temperature

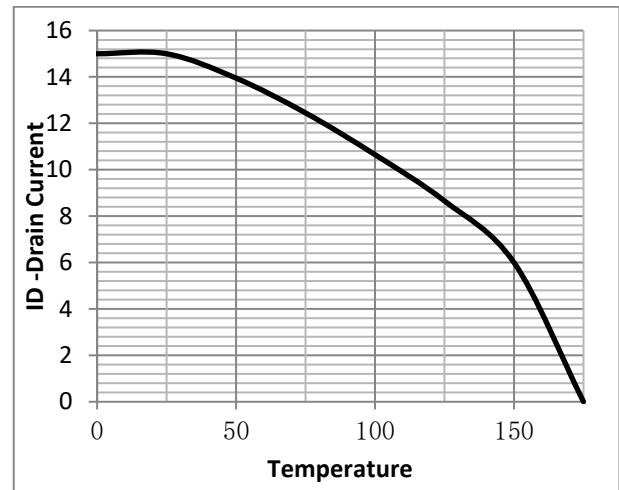

Fig.11 Switching Time Measurement Circuit

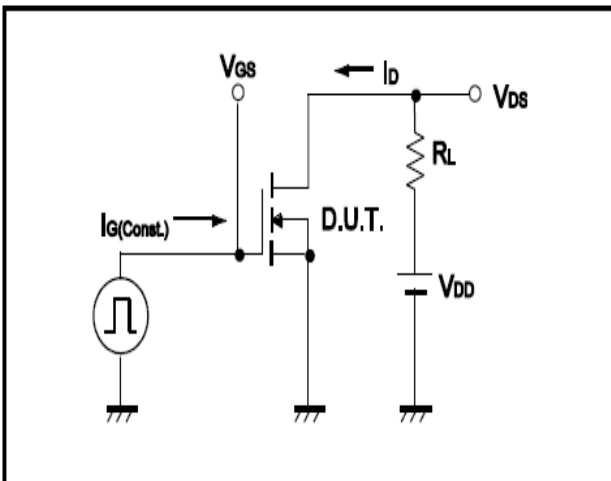

Fig.12 Gate Charge Waveform

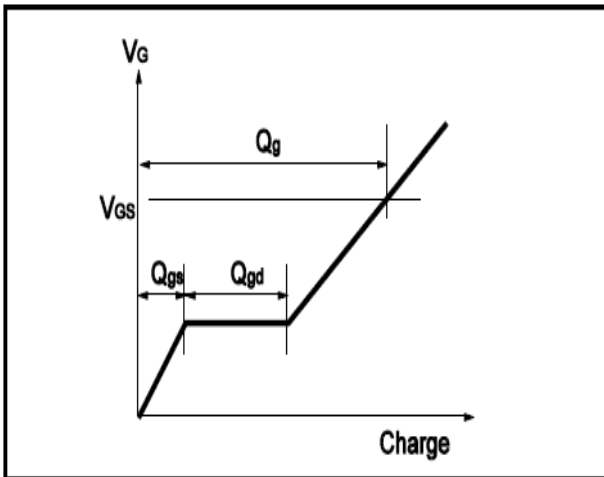

Fig.13 Switching Time Measurement Circuit

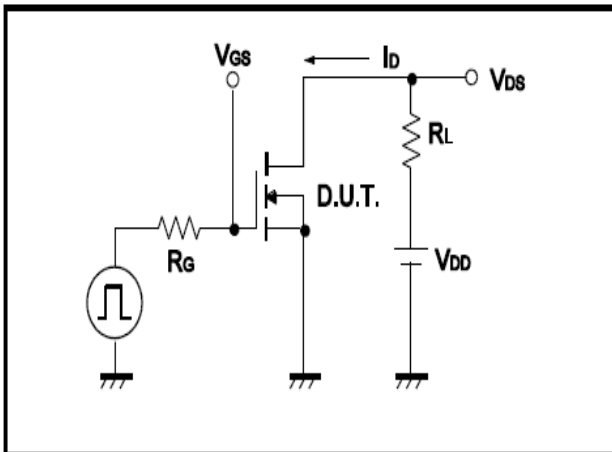
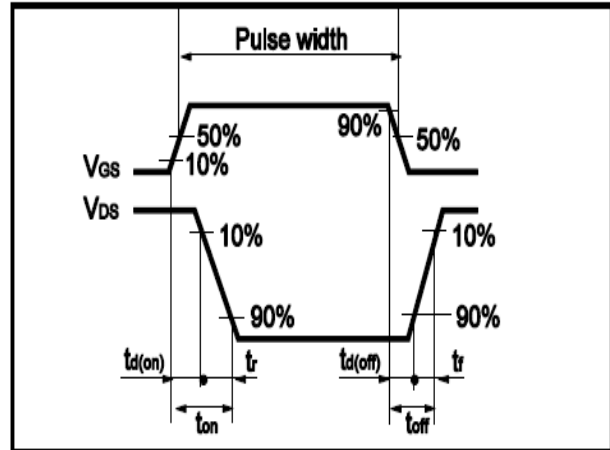

Fig.14 Gate Charge Waveform





•Dimensions(TO-252)

Unit: mm

SYMBOL	min	max	SYMBOL	min	max
A	2.10	2.50	B	0.85	1.25
b	0.50	0.80	b1	0.50	0.90
b2	0.45	0.70	C	0.45	0.70
D	6.30	6.75	D1	5.10	5.50
E	5.30	6.30	e1	2.25	2.35
L1	9.20	10.60	e2	4.45	4.75
L2	0.90	1.75	L3	0.60	1.10
K	0.00	0.23			

