

• General Description

The ZM120P04M combines advanced trench MOSFET technology with a low resistance package to provide extremely low $R_{DS(ON)}$.

• Features

- Advance high cell density Trench technology
- Low $R_{DS(ON)}$ to minimize conductive loss
- Low Gate Charge for fast switching
- Low Thermal resistance

• Application

- Load Switches
- DC/DC
- BLDC Motor driver

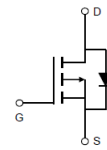
• Product Summary

$V_{DS} = -40V$

$R_{DS(ON)} = 12.0m\Omega$

$I_D = -28A$

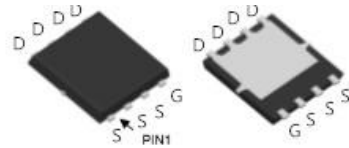
DFN3 x 3
• Ordering Information:

Part NO.	ZM120P04M
Marking	120P04
Packing Information	REEL TAPE
Basic ordering unit (pcs)	5000

• Absolute Maximum Ratings ($T_c = 25^\circ C$)

Parameter	Symbol	Rating	Unit
Drain-Source Voltage	V_{DS}	-40	V
Gate-Source Voltage	V_{GS}	± 20	V
Continuous Drain Current	$I_{D@TC=25^\circ C}$	-28	A
	$I_{D@TC=75^\circ C}$	-21	A
	$I_{D@TC=100^\circ C}$	-17.6	A
Pulsed Drain Current ①	I_{DM}	-84	A
Total Power Dissipation ②	$P_D@T_A=25^\circ C$	18	W
Total Power Dissipation	$P_D@T_A=25^\circ C$	0.9	W
Operating Junction Temperature	T_J	-55 to 150	$^\circ C$
Storage Temperature	T_{STG}	-55 to 150	$^\circ C$
Single Pulse Avalanche Energy @ $L=0.1mH$	E_{AS}	125	mJ

•Thermal resistance

Parameter	Symbol	Min.	Typ.	Max.	Unit
Thermal resistance, junction - case ^②	R _{thJC}	-	-	7.1	° C/W
Thermal resistance, junction - ambient	R _{thJA}	-	-	140	° C/W
Soldering temperature, wave soldering for 10s	T _{sold}	-	-	265	° C

•Electronic Characteristics

Parameter	Symbol	Condition	Min.	Typ	Max.	Unit
Drain-Source Breakdown Voltage	BV _{DSS}	V _{GS} =0V, I _D =-250uA	-40			V
Gate Threshold Voltage	V _{GS(TH)}	V _{GS} =V _{DS} , I _D =-250uA	-1.2		-2.5	V
Drain-Source Leakage Current	I _{DSS}	V _{DS} =-40V, V _{GS} =0V			-1.0	uA
Gate- Source Leakage Current	I _{GSS}	V _{GS} =±20V, V _{DS} =0V			±100	nA
Static Drain-source On Resistance	R _{DS(ON)}	V _{GS} =-10V, I _D =-15A		12	16	mΩ
		V _{GS} =-4.5V, I _D =-10A		17	21	mΩ
Forward Transconductance	g _{FS}	V _{DS} =-10V, I _D =-5A		18		s
Source-drain voltage	VSD	I _S =-15A			1.28	V

•Electronic Characteristics

Parameter	Symbol	Condition	Min.	Typ	Max.	Unit
Input capacitance	C _{iss}	V _{GS} =0V, V _{DS} =-15V f = 1MHz	-	2750	-	pF
Output capacitance	C _{oss}		-	185	-	
Reverse transfer capacitance	C _{rss}		-	135	-	

•Gate Charge characteristics(T_a = 25°C)

Parameter	Symbol	Condition	Min.	Typ	Max.	Unit
Total gate charge	Q _g	V _{DD} =-15V	-	30	-	nC
Gate - Source charge	Q _{gs}	I _D = -10A	-	9	-	
Gate - Drain charge	Q _{gd}	V _{GS} = -4.5V	-	15	-	

Note: ① Pulse Test : Pulse width ≤ 300μs, Duty cycle ≤ 2% ;

② Device mounted on FR-4 substrate PC board, 2oz copper, with thermal bias to bottom layer 1inch square copper plate;

Fig.1 Gate-Charge Characteristics

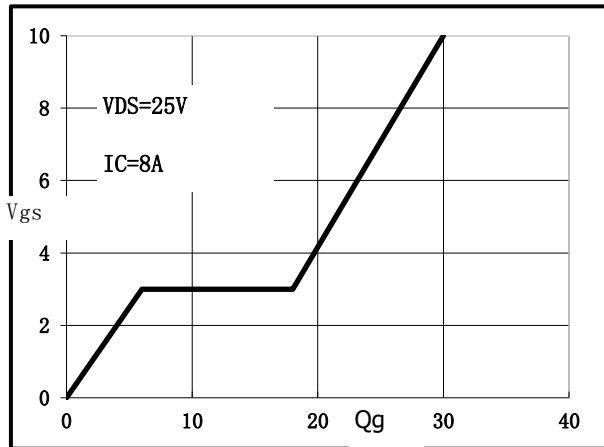

Fig.2 Capacitance Characteristics

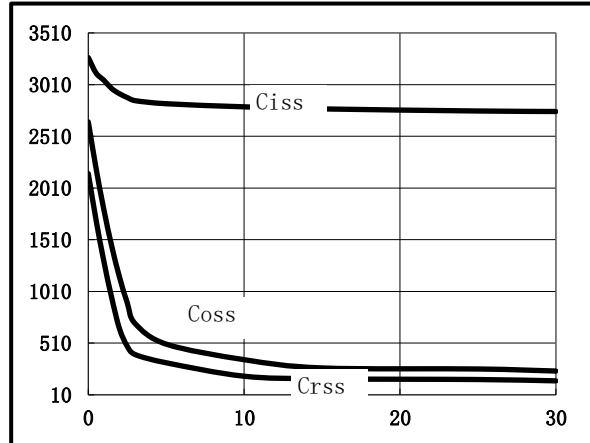

Fig.3 Power Dissipation Derating Curve

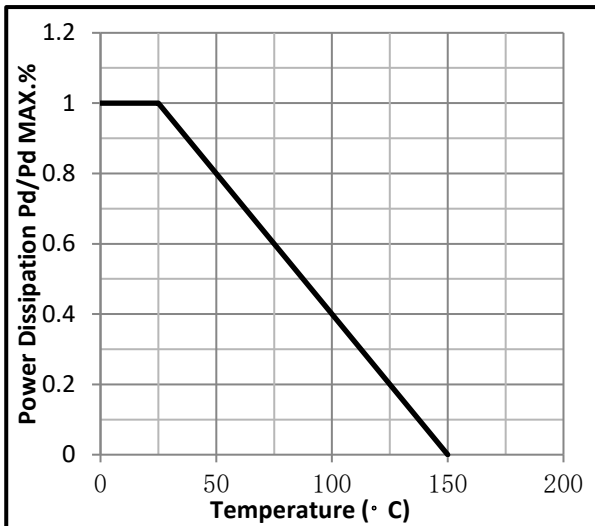

Fig.4 Typical output Characteristics

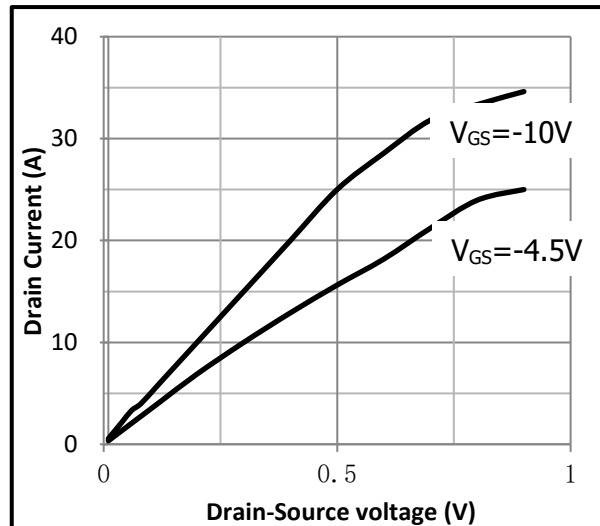

Fig.5 Threshold Voltage V.S Junction Temperature

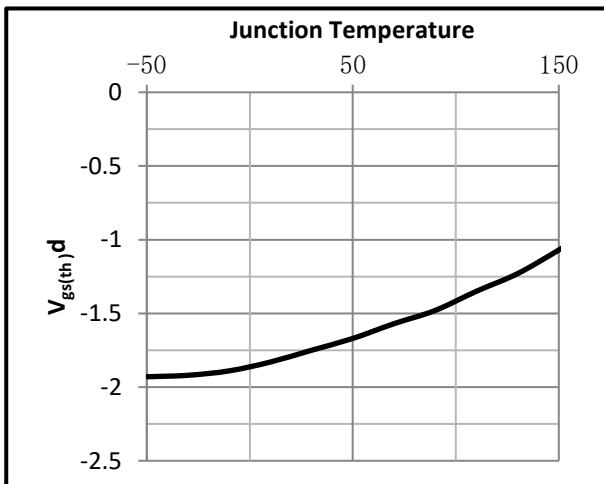

Fig.6 Resistance V.S Drain Current

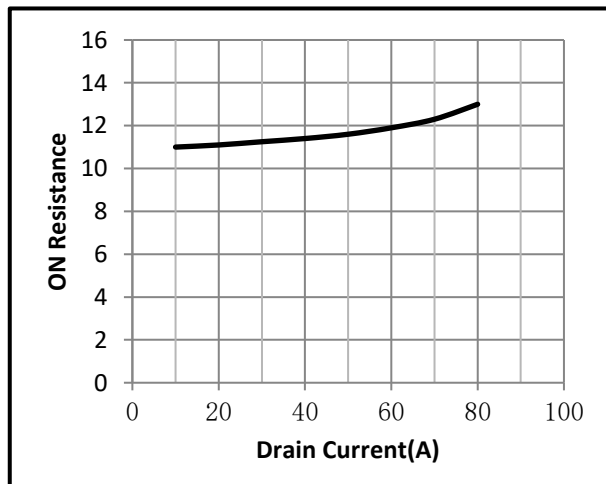

Fig.7 On-Resistance VS Gate Source Voltage

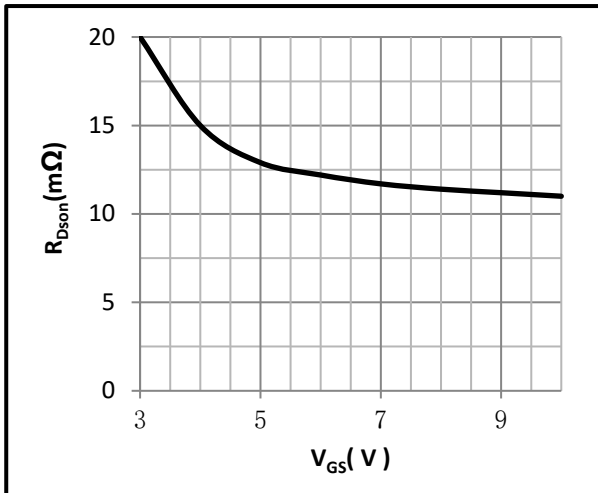

Fig.8 On-Resistance V.S Junction Temperature

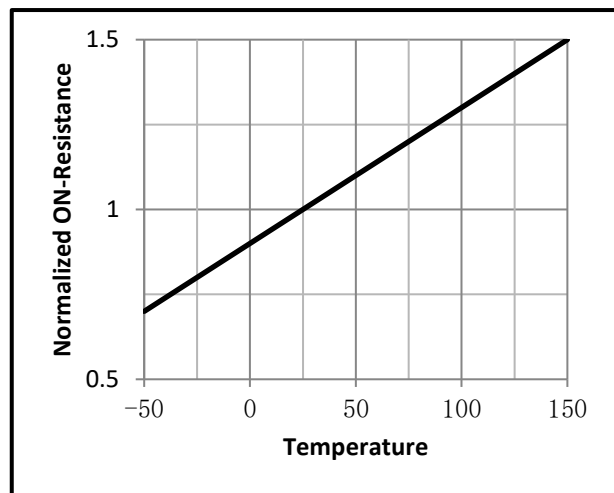

Fig.9 Switching Time Measurement Circuit

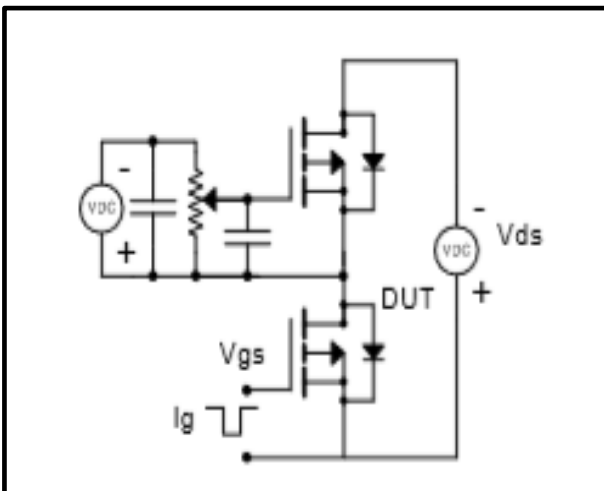

Fig.10 Gate Charge Waveform

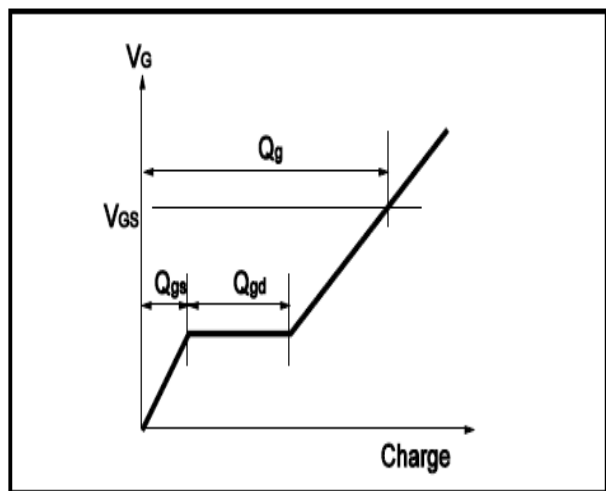

Fig.11 Switching Time Measurement Circuit

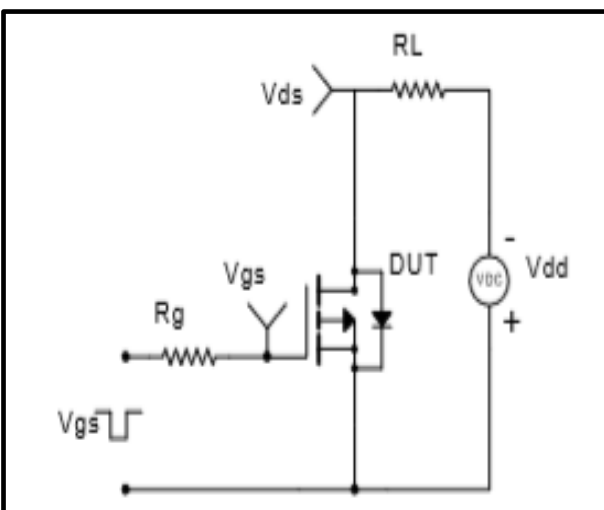
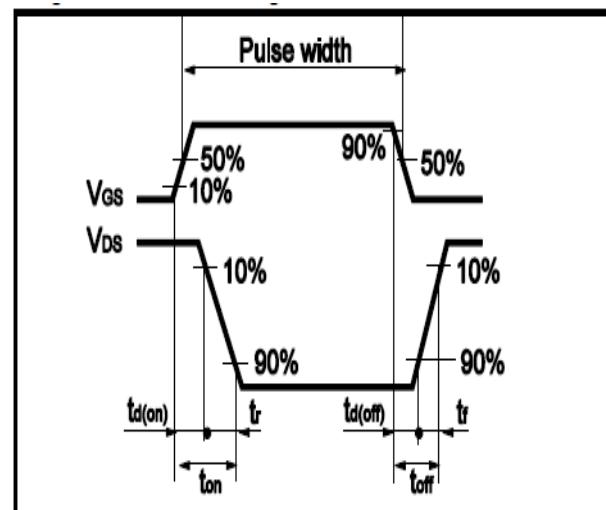

Fig.12 Gate Charge Waveform





•Dimensions(DFN3x3)

Unit: mm

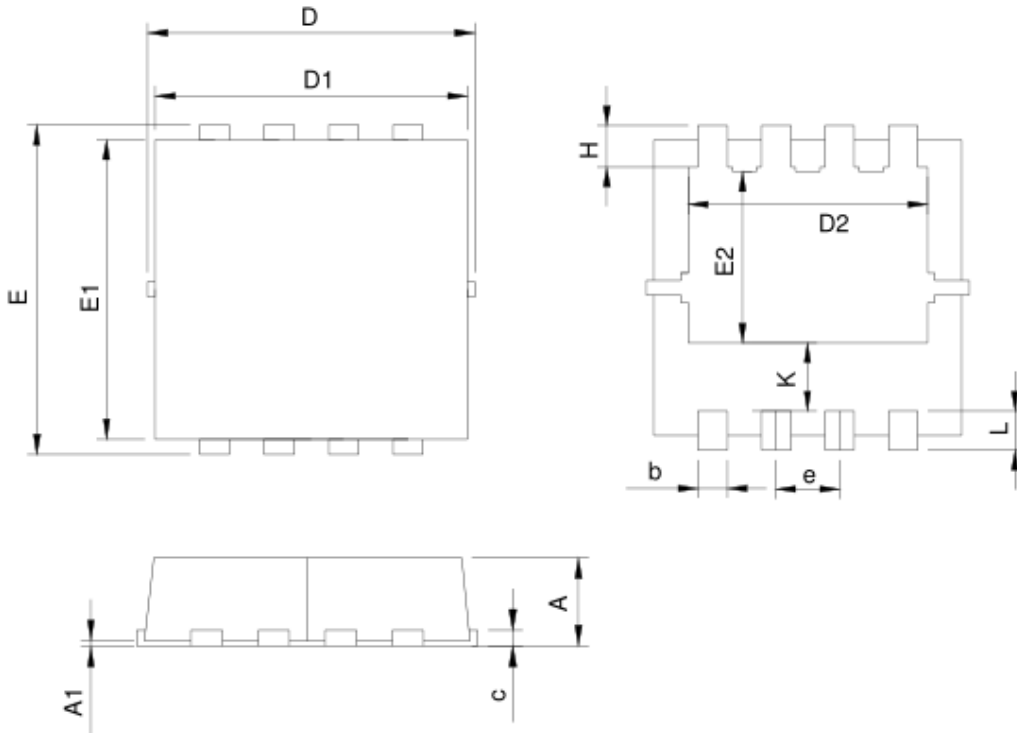

SYMBOL	DFN3.3x3.3-8			
	MILLIMETERS		INCHES	
	MIN.	MAX.	MIN.	MAX.
A	0.70	1.00	0.028	0.039
A1	0.00	0.05	0.000	0.002
b	0.25	0.35	0.010	0.014
c	0.14	0.20	0.006	0.008
D	3.10	3.50	0.122	0.138
D1	3.05	3.25	0.120	0.128
D2	2.35	2.55	0.093	0.100
E	3.10	3.50	0.122	0.138
E1	2.90	3.10	0.114	0.122
E2	1.64	1.84	0.065	0.072
e	0.65 BSC		0.026 BSC	
H	0.32	0.52	0.013	0.020
K	0.59	0.79	0.023	0.031
L	0.25	0.55	0.010	0.022

RECOMMENDED LAND PATTERN

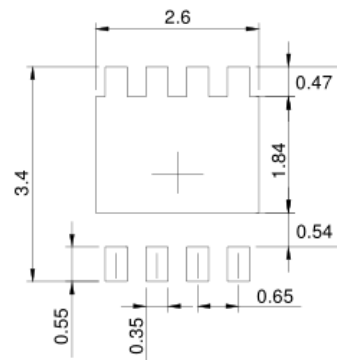

UNIT: mm