

• General Description

The ZM023N04N combines advanced trench MOSFET technology with a low resistance package to provide extremely low $R_{DS(ON)}$.

• Features

- Advance high cell density Trench technology
- Low $R_{DS(ON)}$ to minimize conductive loss
- Low Gate Charge for fast switching
- Low Thermal resistance

• Application

- Synchronous Rectification for AC-DC/DC-DC converter
- BLDC Motor driver

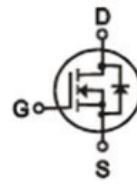
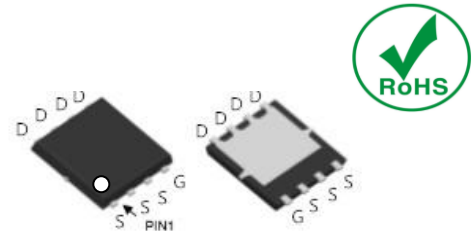
• Product Summary

 $V_{DS}=40V$
 $R_{DS(ON)} = 2.3m\Omega$
 $I_D=100A$

DFN5 x 6
• Ordering Information:

Part NO.	ZM023N04N
Marking	ZM023N04
Packing Information	REEL TAPE
Basic ordering unit (pcs)	3000

• Absolute Maximum Ratings ($T_C = 25^\circ C$)

Parameter	Symbol	Rating	Unit
Drain-Source Voltage	V_{DS}	40	V
Gate-Source Voltage	V_{GS}	± 20	V
Continuous Drain Current	$I_D@TC=25^\circ C$	100	A
	$I_D@TC=75^\circ C$	76	A
	$I_D@TC=100^\circ C$	63	A
Pulsed Drain Current ①	I_{DM}	200	A
Total Power Dissipation	$P_D@TC=25^\circ C$	85	W
Total Power Dissipation	$P_D@TA=25^\circ C$	3.4	W
Operating Junction Temperature	T_J	-55 to 150	$^\circ C$
Storage Temperature	T_{STG}	-55 to 150	$^\circ C$
Single Pulse Avalanche Energy ($L=0.5mH, V_{GS}=10V, R_g=25\Omega, T_J=25$)	EAS	590	mJ
Single Pulse Avalanche Energy ($L=0.1mH, V_{GS}=10V, R_g=25\Omega, T_J=25$)	EAS	308	mJ

•Thermal resistance

Parameter	Symbol	Min.	Typ.	Max.	Unit
Thermal resistance, junction - case	R_{thJC}	-	-	1.5	$^{\circ}C/W$
Thermal resistance, junction - ambient	R_{thJA}	-	-	37	$^{\circ}C/W$
Soldering temperature, wave soldering for 10s	T_{sold}	-	-	265	$^{\circ}C$

•Electronic Characteristics

Parameter	Symbol	Condition	Min.	Typ	Max.	Unit
Drain-Source Breakdown Voltage	BV_{DSS}	$V_{GS}=0V, I_D=250\mu A$	40			V
Gate Threshold Voltage	$V_{GS(TH)}$	$V_{GS}=V_{DS}, I_D=250\mu A$	1.2		2.5	V
Drain-Source Leakage Current	I_{DSS}	$V_{DS}=40V, V_{GS}=0V$			1.0	μA
Gate- Source Leakage Current	I_{GSS}	$V_{GS}=\pm 20V, V_{DS}=0V$			± 100	nA
Static Drain-source On Resistance	$R_{DS(ON)}$	$V_{GS}=10V, I_D=24A$		2.3	3.2	m Ω
		$V_{GS}=4.5V, I_D=12A$		3.4	4.5	m Ω
Forward Transconductance	g_{FS}	$V_{DS}=25V, I_D=10A$		20		S
Source-drain voltage	V_{SD}	$I_S=24A$			1.28	V

•Electronic Characteristics

Parameter	Symbol	Condition	Min.	Typ	Max.	Unit
Input capacitance	C_{iss}	$V_{GS}=0V, V_{DS}=25V$ $f = 1MHz$	-	5340	-	pF
Output capacitance	C_{oss}		-	480	-	
Reverse transfer capacitance	C_{rss}		-	300	-	

•Gate Charge characteristics($T_a = 25^{\circ}C$)

Parameter	Symbol	Condition	Min.	Typ	Max.	Unit
Gate Resistance	R_g	$f = 1MHz$		1.0		Ω
Total gate charge	Q_g	$V_{DD} = 30V$ $I_D = 20A$ $V_{GS} = 10V$	-	76	-	nC
Gate - Source charge	Q_{gs}		-	12	-	
Gate - Drain charge	Q_{gd}		-	13	-	

Turn-ON Delay time	$t_{D(on)}$	$V_{GS}=10V, V_{DS}=15V$ $R_G = 3.3\Omega,$ $I_D = 20A$	12	ns
Turn-ON Rise time	t_r		7	ns
Turn-Off Delay time	$t_{D(off)}$		53	ns
Turn-Off Fall time	t_f		14	ns
Reverse Recovery Time	t_{RR}	$V_{DD} = 20 V,$ $dI_S/dt = 100 A/s,$ $I_S = 30 A$	19.3	ns
Charge Time	t_a		10.9	ns
Discharge Time	t_b		8.4	ns
Reverse Recovery Charge	Q_{RR}		9.5	ns

Note: ① Pulse Test : Pulse width $\leq 300\mu s$, Duty cycle $\leq 2\%$;

Fig.1 Gate-Charge Characteristics

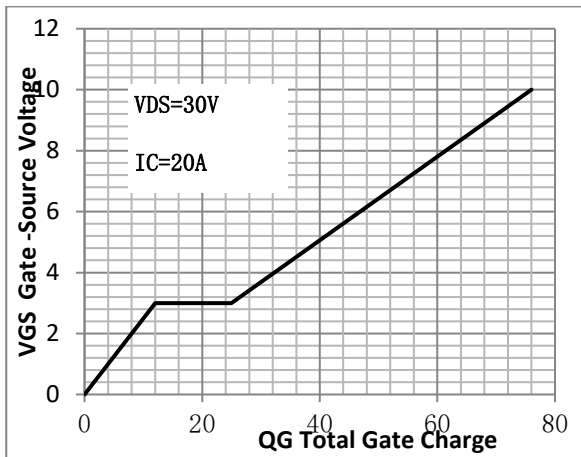

Fig.2 Capacitance Characteristics

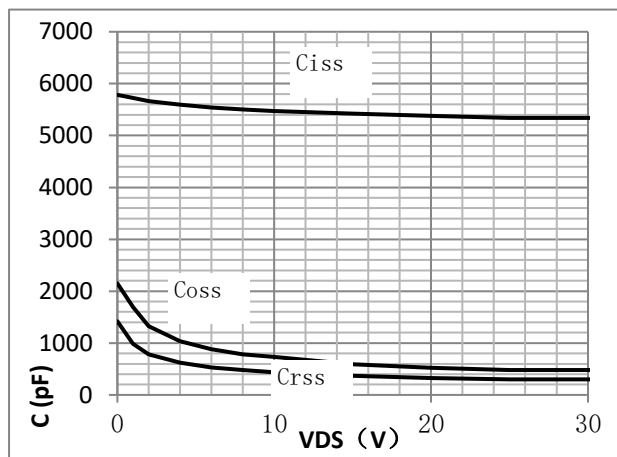

Fig.3 Power Dissipation

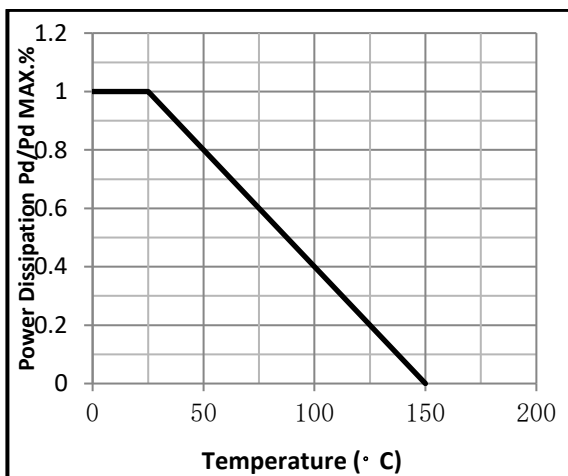

Fig.4 Typical output Characteristics

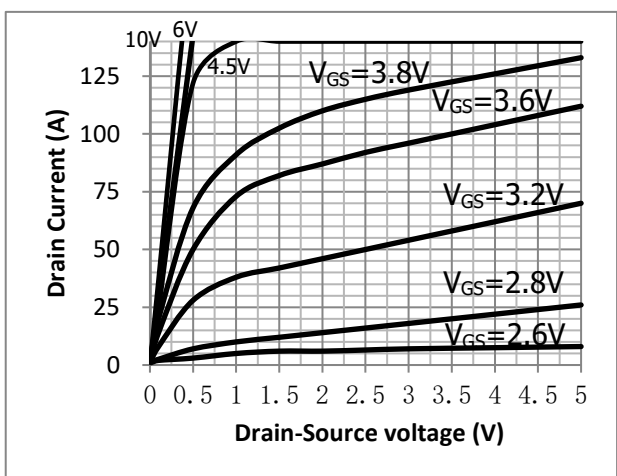

Fig.5 Threshold Voltage V.S Junction Temperature Fig.6 Resistance V.S Drain Current

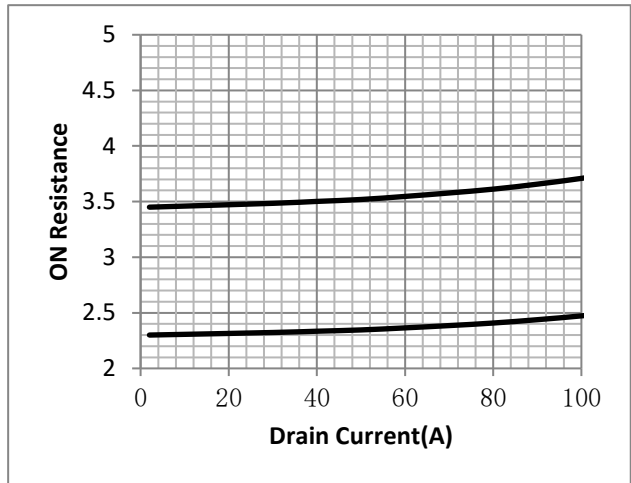
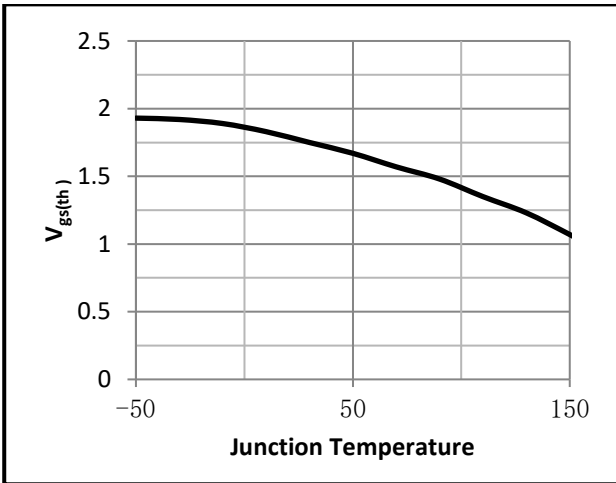

Fig.7 On-Resistance VS Gate Source Voltage

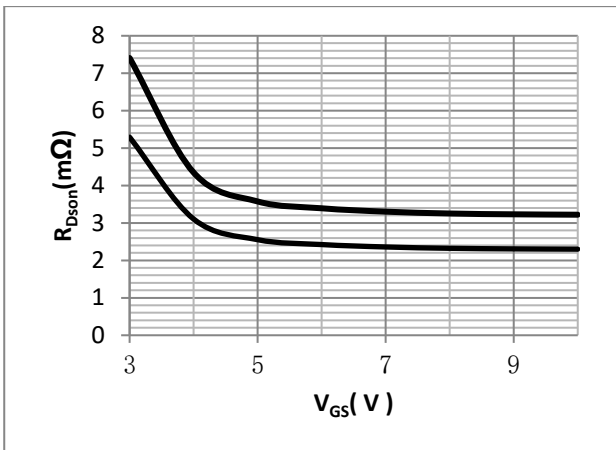

Fig.8 On-Resistance V.S Junction Temperature

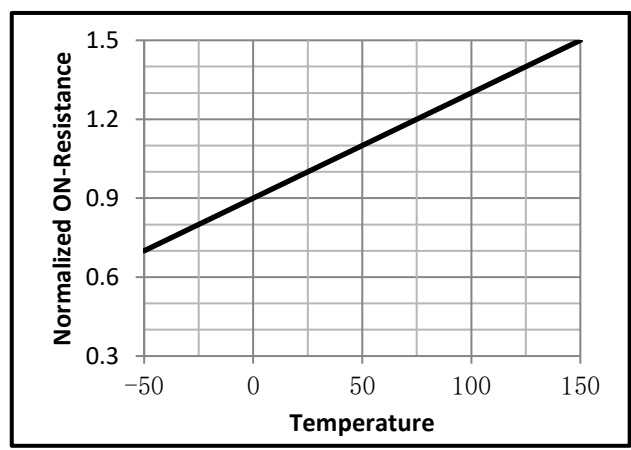

Figure 9. Diode Forward Voltage vs. Current

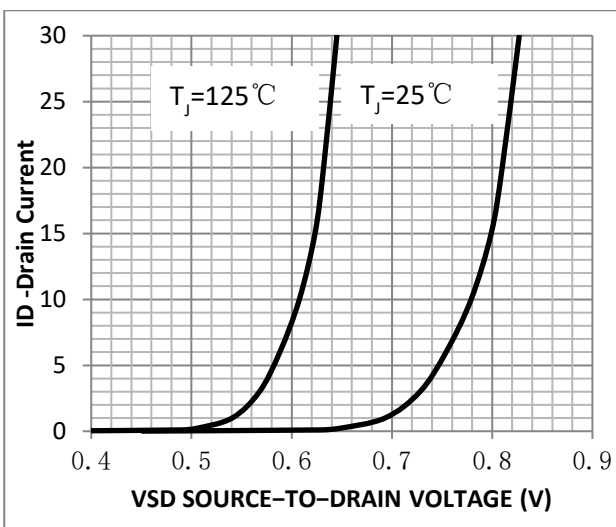

Figure 10. Transfer Characteristics

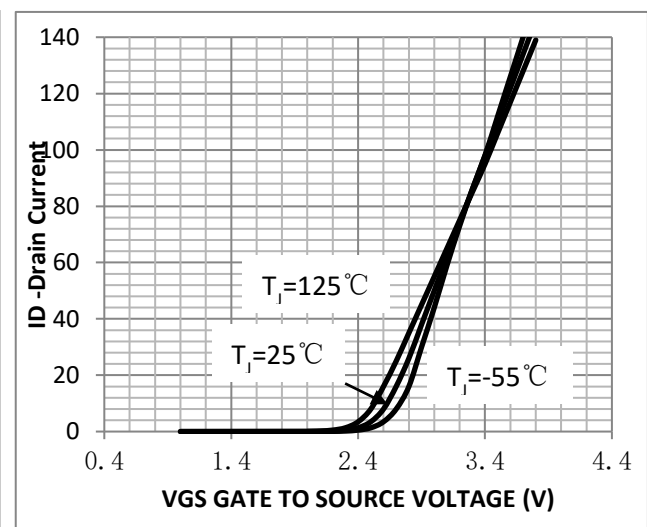

Fig.11 SOA Maximum Safe Operating Area

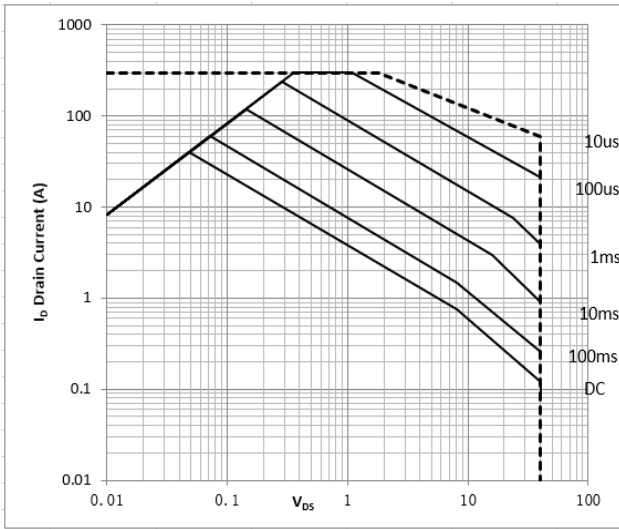

Fig.12 I_D vs. Junction Temperature

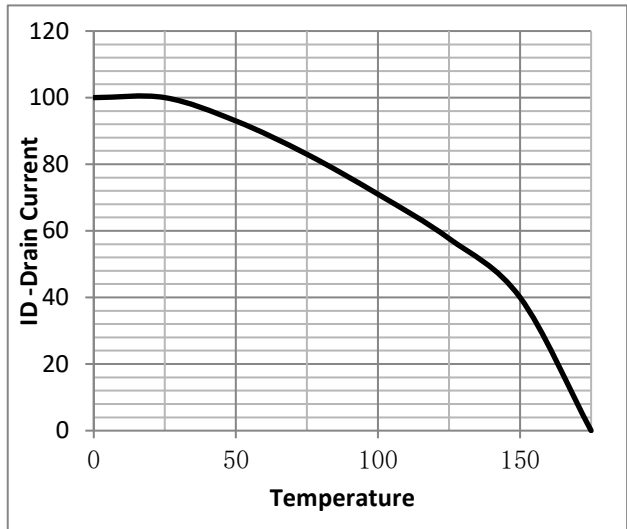

Fig.9 Switching Time Measurement Circuit

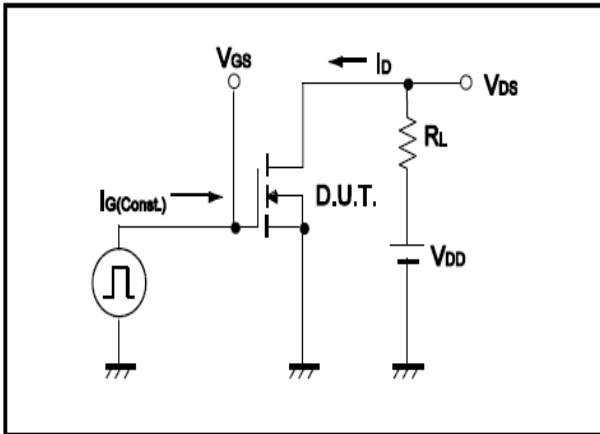

Fig.10 Gate Charge Waveform

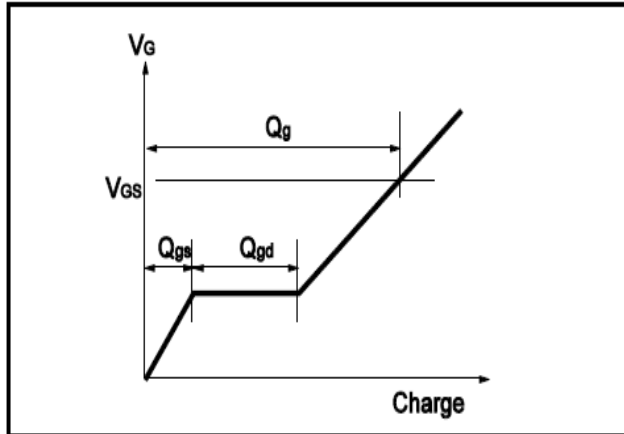

Fig.11 Switching Time Measurement Circuit

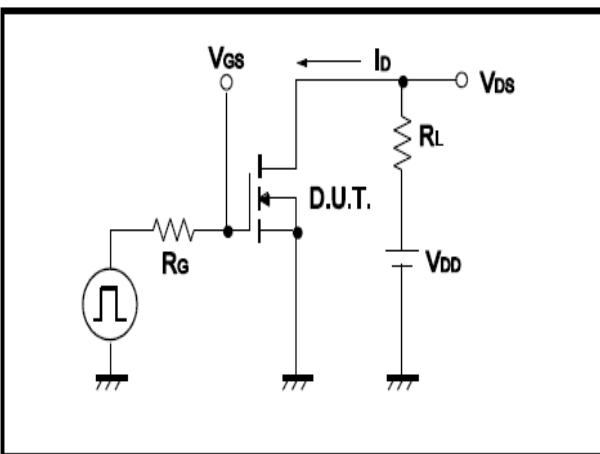
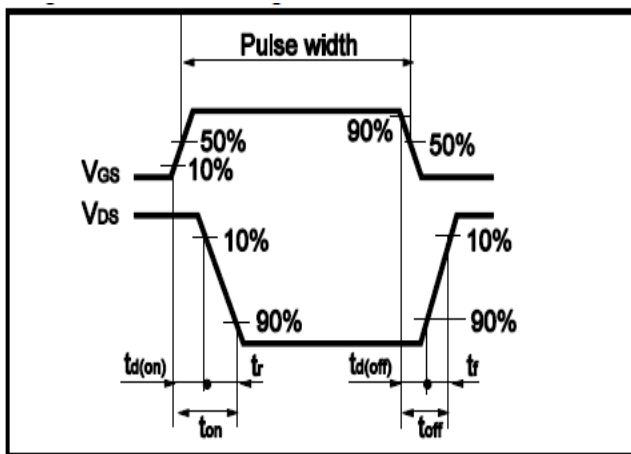

Fig.12 Gate Charge Waveform





•Dimensions (DFN5x6)

Unit: mm

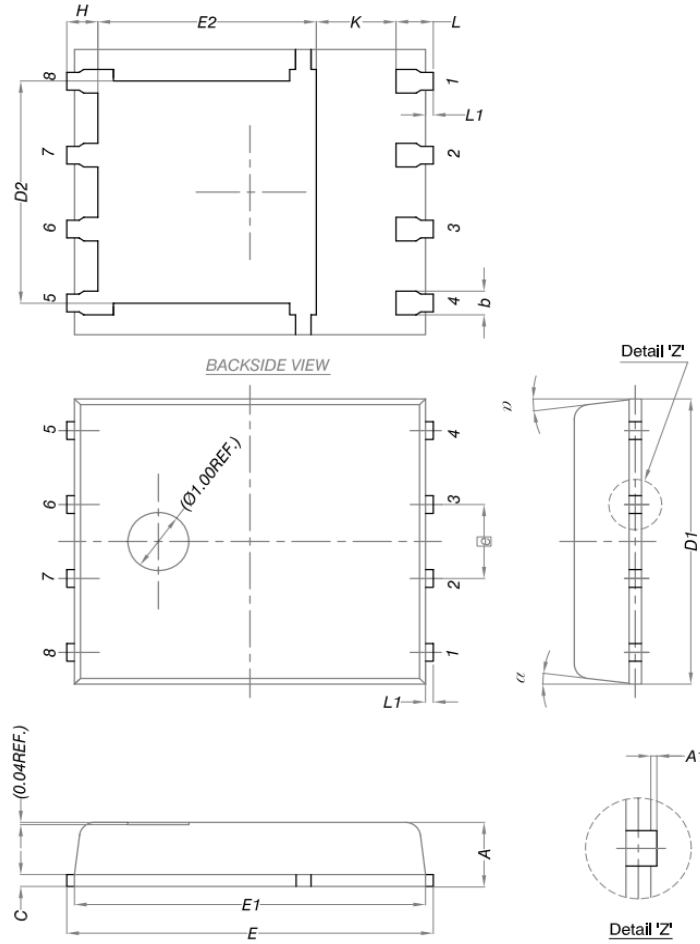

DIM.	MILLIMETERS		
	MIN.	NOM.	MAX.
A	0.90	1.00	1.10
A1	0	-	0.05
b	0.33	0.41	0.51
C	0.20	0.25	0.30
D1	4.80	4.90	5.00
D2	3.61	3.81	3.96
E	5.90	6.00	6.10
E1	5.70	5.75	5.80
E2	3.38	3.58	3.78
\square e	1.27 BSC		
H	0.41	0.51	0.61
K	1.10	-	-
L	0.51	0.61	0.71
L1	0.06	0.13	0.20
α	0°	-	12°