

• General Description

It combines advanced MOSFET technology with a low resistance package to provide extremely low $R_{DS(ON)}$.

• Features

- Advance device constructure
- Low $R_{DS(ON)}$ to minimize conduction loss
- Low Gate Charge for fast switching
- Low Thermal resistance

• Application

- Synchronous Rectification for AC-DC/DC-DC converter
- Power Tools

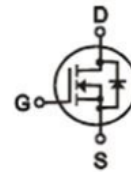
• Product Summary

$V_{DS} = 60V$

$R_{DS(ON)} = 5.2m\Omega$

$I_D = 80A$

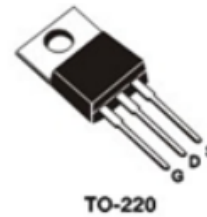
• Ordering Information:

Part NO.	ZMS052N06P
Marking	ZMS052N06
Packing Information	TUBE
Basic ordering unit (pcs)	500

• Absolute Maximum Ratings (T_C = 25°C)

Parameter	Symbol	Rating	Unit
Drain-Source Voltage	V_{DS}	60	V
Gate-Source Voltage	V_{GS}	±20	V
Continuous Drain Current	$I_{D@TC=25^{\circ}C}$	80	A
	$I_{D@TC=75^{\circ}C}$	61	A
	$I_{D@TC=100^{\circ}C}$	50	A
Pulsed Drain Current ①	I_{DM}	240	A
Total Power Dissipation	$P_D@TC=25^{\circ}C$	125	W
Total Power Dissipation	$P_D@TA=25^{\circ}C$	3.4	W
Operating Junction Temperature	T_J	-55 to 150	°C
Storage Temperature	T_{STG}	-55 to 150	°C
Single Pulse Avalanche Energy	E_{AS}	280	mJ

•Thermal resistance

Parameter	Symbol	Min.	Typ.	Max.	Unit
Thermal resistance, junction - case	R_{thJC}			1.0	° C/W
Thermal resistance, junction - ambient	R_{thJA}	-	-	37	° C/W
Soldering temperature, wavesoldering for 10s	T_{sold}	-	-	265	° C

•Electronic Characteristics

Parameter	Symbol	Condition	Min.	Typ	Max.	Unit
Drain-Source Breakdown Voltage	BV_{DSS}	$V_{GS} = 0V, I_D = 250\mu A$	60			V
Gate Threshold Voltage	$V_{GS(TH)}$	$V_{GS} = V_{DS}, I_D = 250\mu A$	1.5		2.5	V
Drain-Source Leakage Current	I_{DSS}	$V_{DS} = 0.8 BV_{DSS}, V_{GS} = 0V$			1.0	μA
Gate- Source Leakage Current	I_{GSS}	$V_{GS} = \pm 20V, V_{DS} = 0V$			± 100	nA
Static Drain-source On Resistance	$R_{DS(ON)}$	$V_{GS} = 10V, I_D = 10A$		5.2	6.5	m Ω
		$V_{GS} = 4.5V, I_D = 5A$		6.8	8.5	m Ω
Forward Transconductance	g_{FS}	$V_{DS} = 25V, I_D = 10A$		16		s
Source-drain voltage	V_{SD}	$I_S = 10A$			1.28	V

•Electronic Characteristics

Parameter	Symbol	Condition	Min.	Typ	Max.	Unit
Input capacitance	C_{iss}	$f = 1MHz$ $V_{DS} = 25V$	-	1910	-	pF
Output capacitance	C_{oss}		-	1070	-	
Reverse transfer capacitance	C_{rss}		-	22	-	

•Gate Charge characteristics($T_a = 25^\circ C$)

Parameter	Symbol	Condition	Min.	Typ	Max.	Unit
Total gate charge	Q_g	$V_{DD} = 25V$	-	24	-	nC
Gate - Source charge	Q_{gs}	$I_D = 8A$	-	5	-	
Gate - Drain charge	Q_{gd}	$V_{GS} = 10V$	-	3.3	-	

Note: ① Pulse Test : Pulse width $\leq 300\mu s$, Duty cycle $\leq 2\%$;

Fig.1 Gate-Charge Characteristics

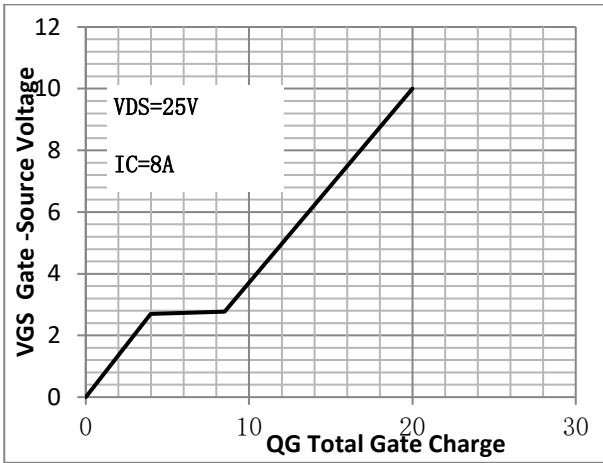

Fig.2 Capacitance Characteristics

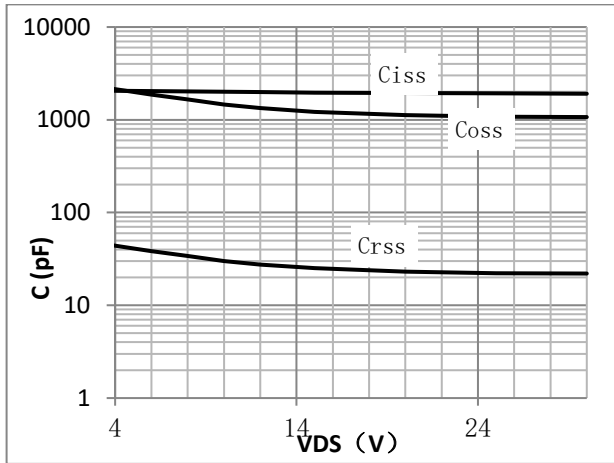

Fig.3 Power Dissipation

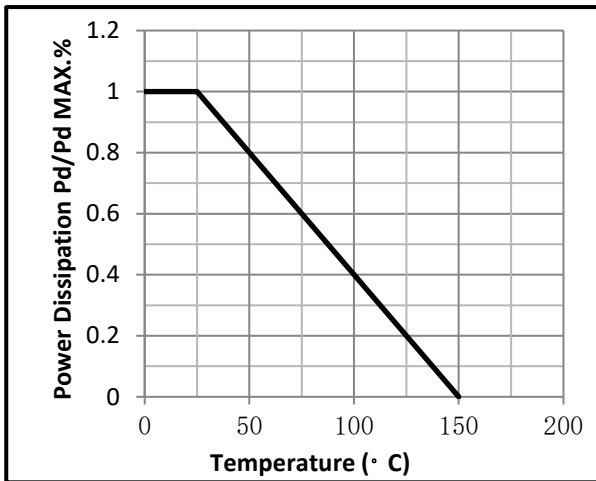

Fig.4 Typical output Characteristics

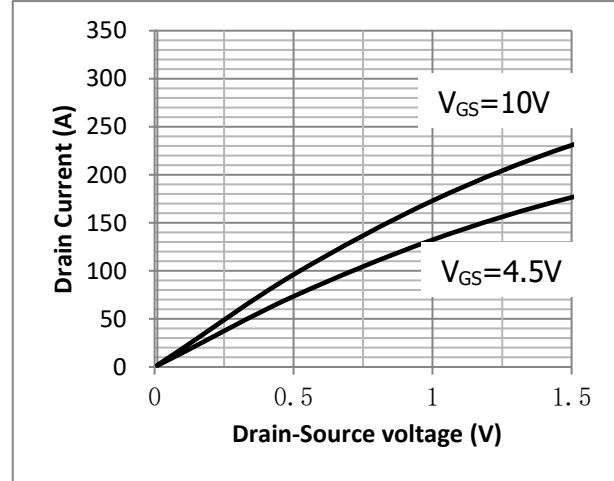

Fig.5 Threshold Voltage V.S Junction Temperature

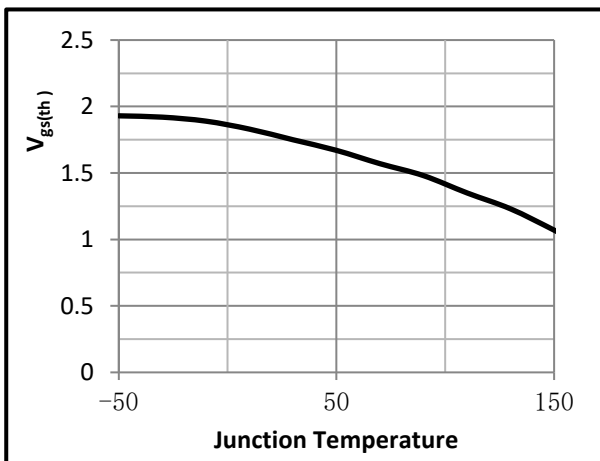

Fig.6 Resistance V.S Drain Current

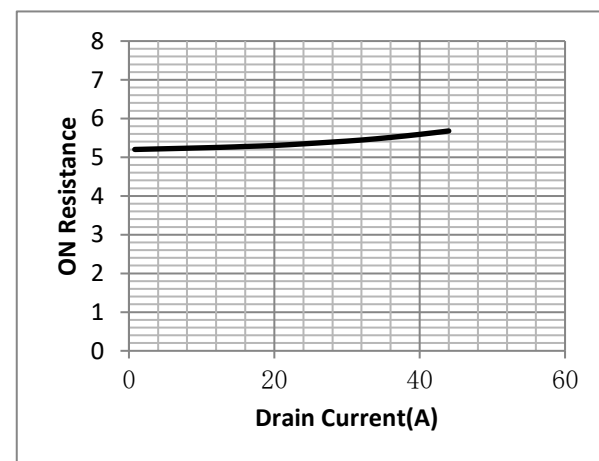

Fig.7 On-Resistance VS Gate Source Voltage

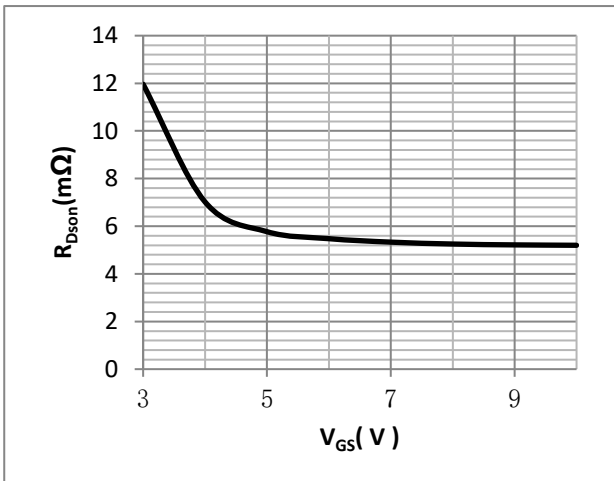

Fig.8 On-Resistance V.S Junction Temperature

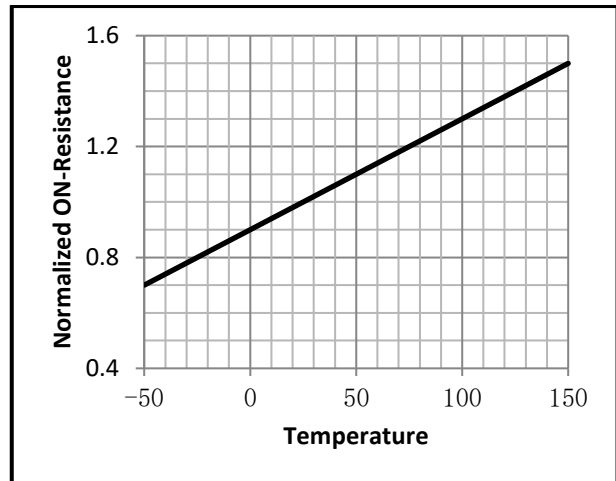

Fig.9 SOA Maximum Safe Operating Area

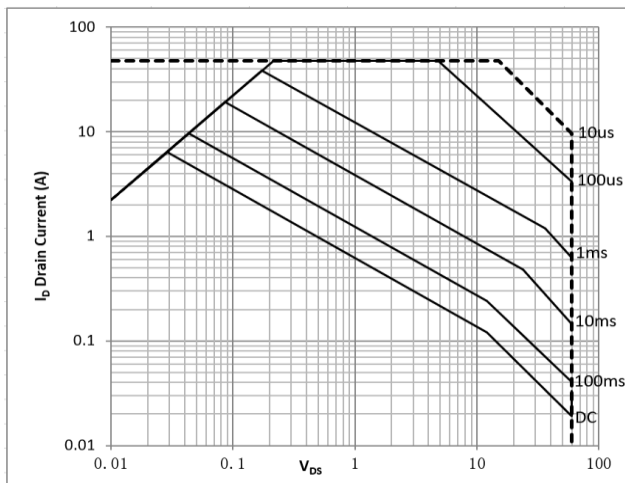

Fig.10 I_D-Junction Temperature

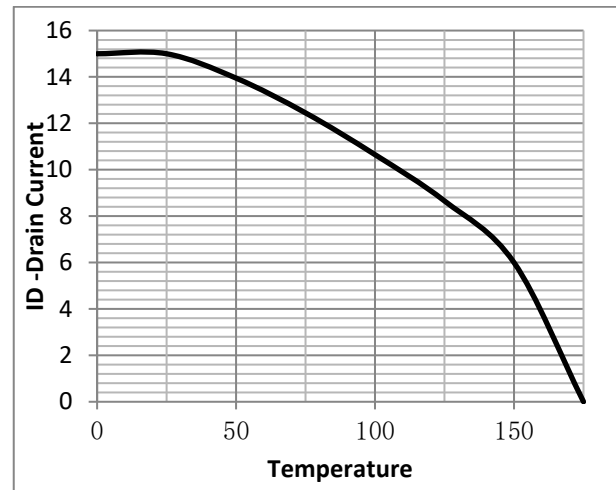

Fig.11 Switching Time Measurement Circuit

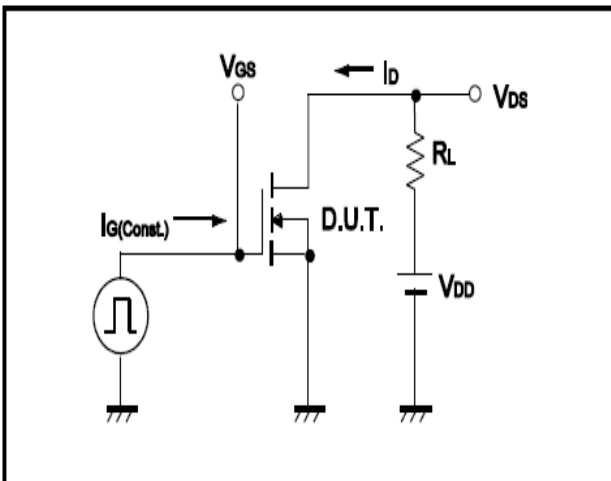

Fig.12 Gate Charge Waveform

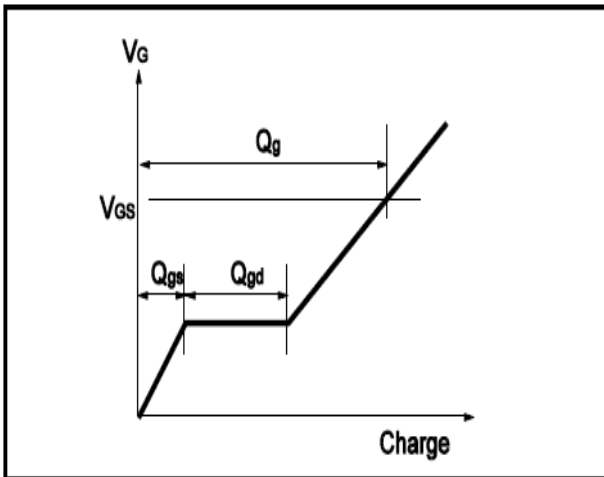

Fig.13 Switching Time Measurement Circuit

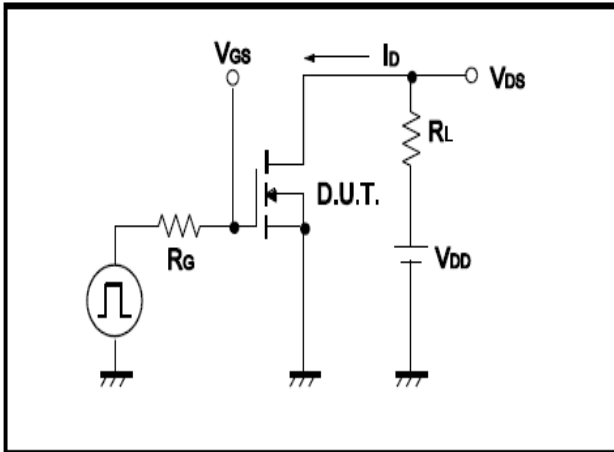
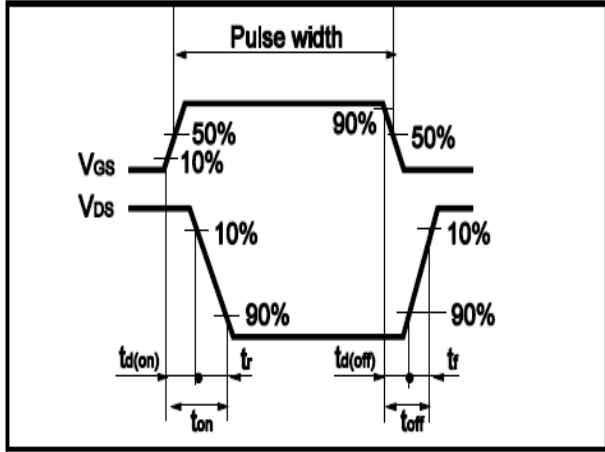

Fig.14 Gate Charge Waveform





• Dimensions (TO-220)

Unit: mm

SYMBOL	min	nom	max	SYMBOL	min	nom	max
A	4.00		4.80	E	9.90		10.70
B	1.20		1.50	e		2.54	
B1	1.00		1.40	F	1.10		1.45
b1	0.65		1.00	L	12.50		14.50
c	0.35		0.75	L1	3.00	3.50	4.00
D	15.00		16.50	Q	2.50		3.00
D1	5.90		6.90	Q1	2.00		3.00
				ΦP	3.60		3.90

