

• General Description

It combines advanced trench MOSFET technology with a low resistance package to provide extremely low $R_{DS(ON)}$.

• Features

- Advance high cell density Trench technology
- Low $R_{DS(ON)}$ to minimize conductive loss
- Low Gate Charge for fast switching
- Low Thermal resistance

• Application

- SMPS 2nd Synchronous Rectifier
- BLDC Motor driver

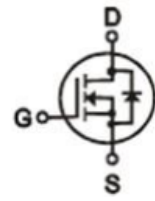
• Product Summary

$V_{DS} = 100V$

$R_{DS(ON)} = 10m\Omega$

$I_D = 12A$

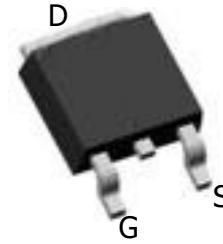

TO-252

• Ordering Information:

Part NO.	ZMS100N10D
Marking	ZMS100N10
Packing Information	REEL TAPE
Basic ordering unit (pcs)	2500

• Absolute Maximum Ratings ($T_C = 25^\circ C$)

Parameter	Symbol	Rating	Unit
Drain-Source Voltage	V_{DS}	100	V
Gate-Source Voltage	V_{GS}	± 20	V
Continuous Drain Current ^②	$I_D @ TC=25^\circ C$	12	A
	$I_D @ TC=75^\circ C$	10.6	A
	$I_D @ TC=100^\circ C$	8.8	A
Pulsed Drain Current ^①	I_{DM}	42	A
Total Power Dissipation ^②	$P_D @ TC=25^\circ C$	60	W
Total Power Dissipation	$P_D @ TA=25^\circ C$	2.0	W
Operating Junction Temperature	T_J	-55 to 150	$^\circ C$
Storage Temperature	T_{STG}	-55 to 150	$^\circ C$
Single Pulse Avalanche Energy @ $L=0.1mH$	E_{AS}	100	mJ

•Thermal resistance

Parameter	Symbol	Min.	Typ.	Max.	Unit
Thermal resistance, junction - case ^②	R _{thJC}	-	-	2.2	° C/W
Thermal resistance, junction - ambient	R _{thJA}	-	-	64	° C/W
Soldering temperature, wavesoldering for 10s	T _{sold}	-	-	265	° C

•Electronic Characteristics

Parameter	Symbol	Condition	Min.	Typ	Max.	Unit
Drain-Source Breakdown Voltage	BV _{DSS}	V _{GS} =0V, I _D =250uA	100			V
Gate Threshold Voltage	V _{GS(TH)}	V _{GS} =V _{DS} , I _D =250uA	1.3		2.5	V
Drain-Source Leakage Current	I _{DSS}	V _{DS} =100V, V _{GS} =0V			1.0	uA
Gate- Source Leakage Current	I _{GSS}	V _{GS} =±20V, V _{DS} =0V			±100	nA
Static Drain-source On Resistance	R _{DS(ON)}	V _{GS} =10V, I _D =20A		10	12.8	mΩ
	R _{DS(ON)}	V _{GS} =4.5V, I _D =16A		12.5	15	mΩ
Forward Transconductance	g _{FS}	V _{DS} =25V, I _D =15A		15		s

•Electronic Characteristics

Parameter	Symbol	Condition	Min.	Typ	Max.	Unit
Input capacitance	C _{iss}	f = 1MHz	-	1400	-	pF
Output capacitance	C _{oss}		-	630	-	
Reverse transfer capacitance	C _{rss}		-	33	-	

Gate Charge characteristics(Ta= 25°C)

Parameter	Symbol	Condition	Min.	Typ	Max.	Unit
Total gate charge	Q _g	V _{DD} =30V	-	20	-	nC
Gate - Source charge	Q _{gs}	I _D = 8A	-	3.6	-	
Gate - Drain charge	Q _{gd}	V _{GS} = 10V	-	2.8	-	

Note: ① Pulse Test : Pulse width ≤ 300μs, Duty cycle ≤ 2% ;

② Device mounted on FR-4 substrate PC board, 2oz copper, with thermal bias to bottom layer 1inch square copper plate;

Fig.1 Gate-Charge Characteristics

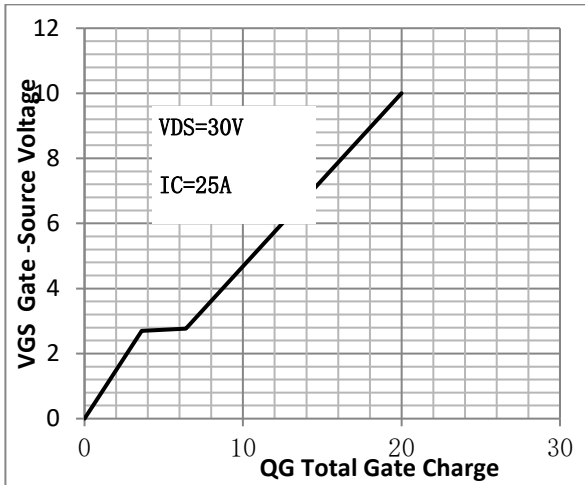

Fig.2 Capacitance Characteristics

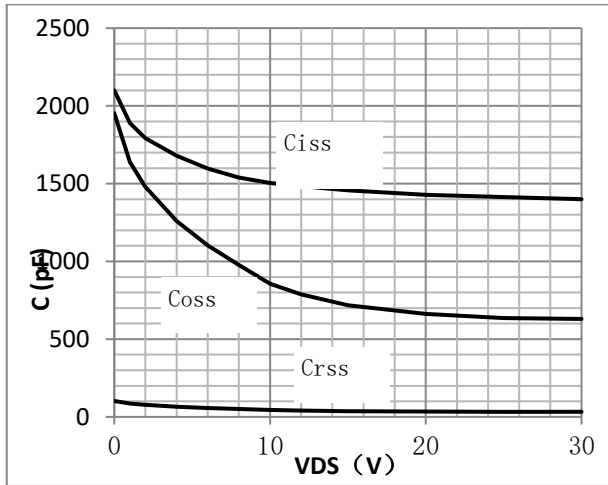

Fig.3 Power Dissipation

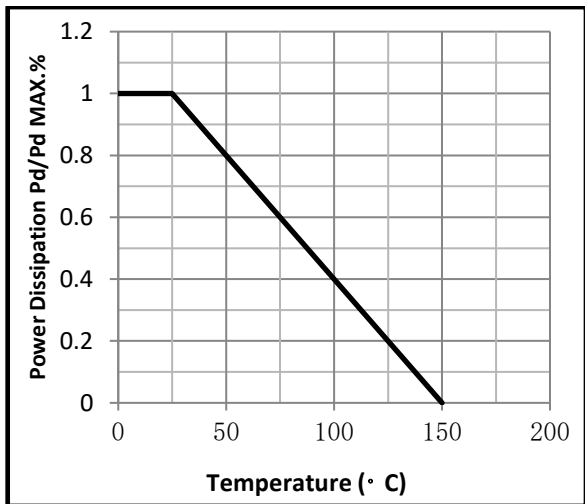

Fig.4 Typical output Characteristics

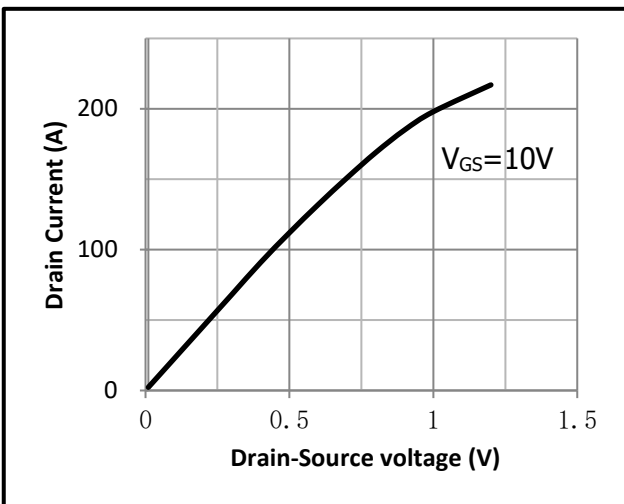

Fig.5 Threshold Voltage V.S Junction Temperature

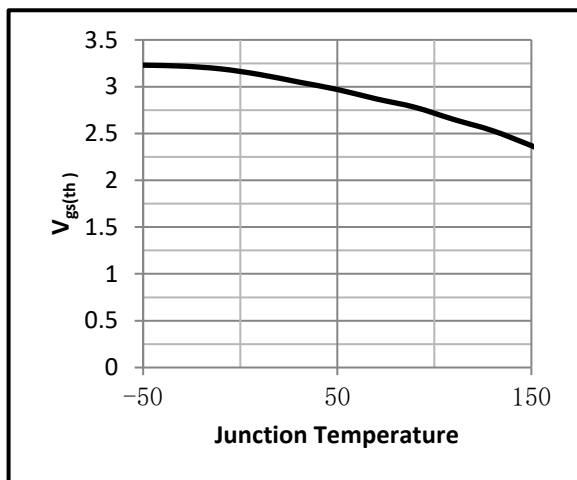

Fig.6 Resistance V.S Drain Current

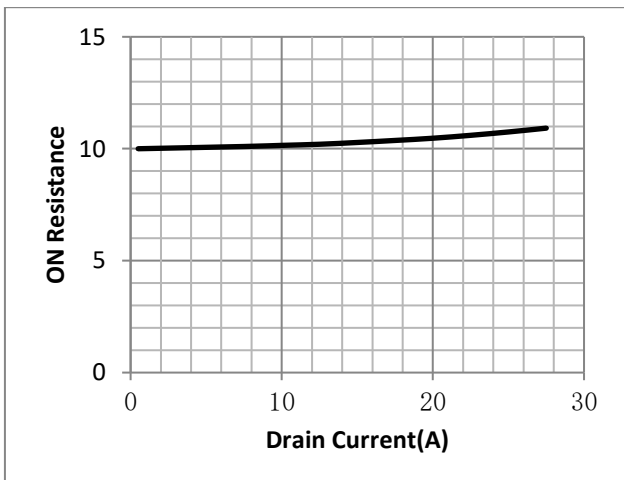

Fig.7 On-Resistance VS Gate Source Voltage

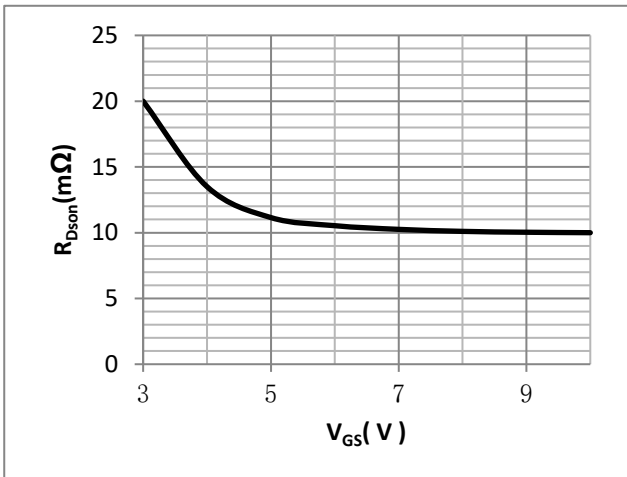

Fig.8 On-Resistance V.S Junction Temperature

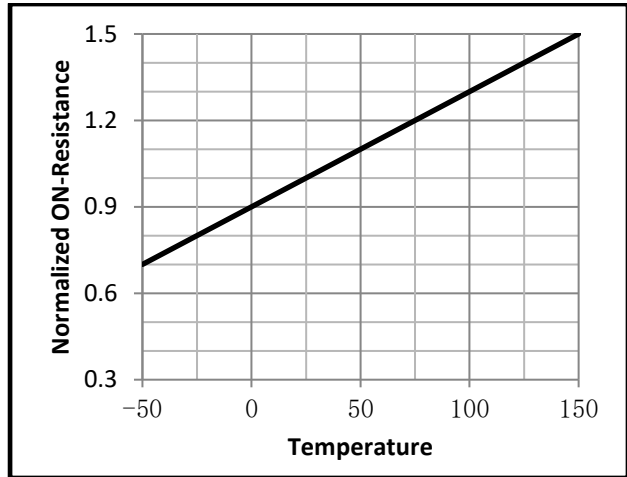

Fig.9 Switching Time Measurement Circuit

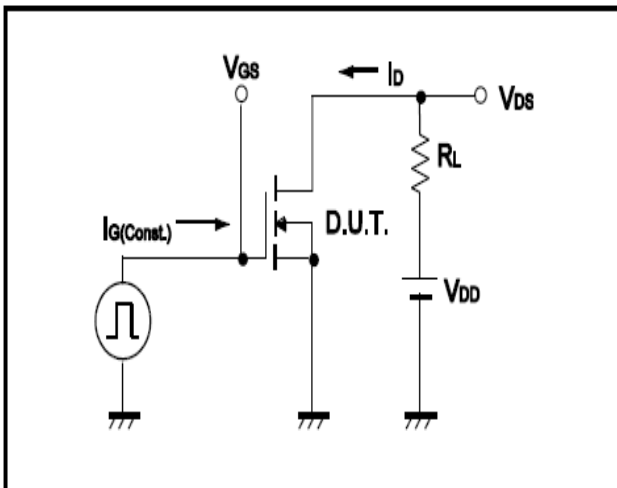

Fig.10 Gate Charge Waveform

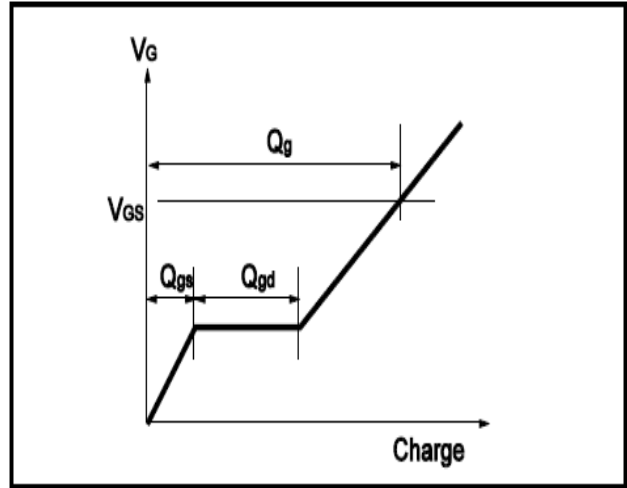

Fig.11 Switching Time Measurement Circuit

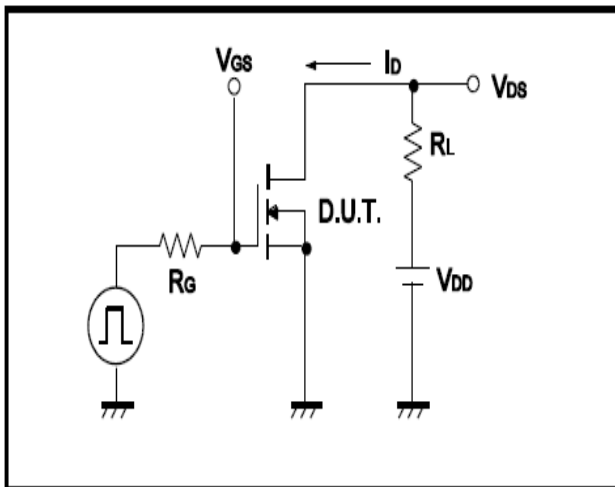
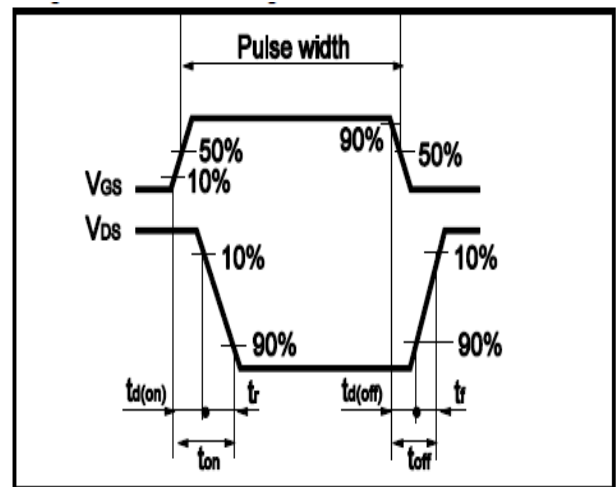

Fig.12 Gate Charge Waveform





• Dimensions (TO-252)

Unit: mm

SYMBOL	min	max	SYMBOL	min	max
A	2.10	2.50	B	0.85	1.25
b	0.50	0.80	b1	0.50	0.90
b2	0.45	0.70	C	0.45	0.70
D	6.30	6.75	D1	5.10	5.50
E	5.30	6.30	e1	2.25	2.35
L1	9.20	10.60	e2	4.45	4.75
L2	0.90	1.75	L3	0.60	1.10
K	0.00	0.23			

