

**General Description**

It combines advanced trench MOSFET technology with a low resistance package to provide extremely low $R_{DS(ON)}$. This device is ideal for load switch and battery protection applications.

Features

- Advance high cell density Trench technology
- Low $R_{DS(ON)}$ to minimize conductive loss
- Low Gate Charge for fast switching
- Low Thermal resistance

Application

- MB/VGA Vcore
- SMPS 2nd Synchronous Rectifier
- POL application
- BLDC Motor driver

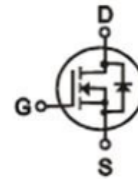
Product Summary

$V_{DS} = 30V$

$R_{DS(ON)} = 0.65m\Omega$

$I_D = 340A$

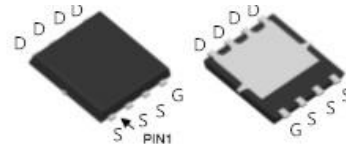

DFN5 x 6

Ordering Information:

Part NO.	ZMS006N03NC
Marking	ZMS006N03
Packing Information	REEL TAPE
Basic ordering unit (pcs)	3000

Absolute Maximum Ratings (T_C=25°C)

Parameter	Symbol	Rating	Unit
Drain-Source Voltage	V_{DS}	30	V
Gate-Source Voltage	V_{GS}	±20	V
Continuous Drain Current	$I_D @ T_C=25^\circ C$	340	A
	$I_D @ T_C=75^\circ C$	258	A
	$I_D @ T_C=100^\circ C$	214	A
Pulsed Drain Current ①	I_{DM}	1020	A
Total Power Dissipation	$P_D @ T_C=25^\circ C$	138	W
Total Power Dissipation	$P_D @ T_A=25^\circ C$	3.5	W
Operating Junction Temperature	T_J	-55 to 150	°C
Storage Temperature	T_{STG}	-55 to 150	°C
Single Pulse Avalanche Energy (L=0.5mH, VGS=10V, Rg=25Ω, TJ=25)	E_{AS}	1120	mJ



Single Pulse Avalanche Energy (L=0.1mH, VGS=10V, Rg=25Ω, TJ=25)	E_{AS}	450	mJ
--	----------	-----	----

• Thermal resistance

Parameter	Symbol	Min.	Typ.	Max.	Unit
Thermal resistance, junction - case	R_{thJC}	-	-	0.9	° C/W
Thermal resistance, junction - ambient	R_{thJA}	-	-	36	° C/W
Soldering temperature, wave soldering for 10s	T_{sold}	-	-	265	° C

• Electronic Characteristics

Parameter	Symbol	Condition	Min.	Typ	Max.	Unit
Drain-Source Breakdown Voltage	BV_{DSS}	$V_{GS} = 0V, I_D = 250\mu A$	30			V
Gate Threshold Voltage	$V_{GS(TH)}$	$V_{GS} = V_{DS}, I_D = 250\mu A$	1.2		2.5	V
Drain-Source Leakage Current	I_{DSS}	$V_{DS} = 30V, V_{GS} = 0V$			1.0	μA
Gate- Source Leakage Current	I_{GSS}	$V_{GS} = \pm 20V, V_{DS} = 0V$			± 100	nA
Static Drain-source On Resistance	$R_{DS(ON)}$	$V_{GS} = 10V, I_D = 100A$		0.65	0.85	mΩ
		$V_{GS} = 4.5V, I_D = 70A$		0.84	1.1	mΩ
Forward Transconductance	g_{FS}	$V_{DS} = 25V, I_D = 100A$		32		s
Source-drain voltage	V_{SD}	$I_S = 24A$			1.28	V

• Electronic Characteristics

Parameter	Symbol	Condition	Min.	Typ	Max.	Unit
Input capacitance	C_{iss}	$f = 1MHz$ $V_{DS} = 25V$	-	4890	-	pF
Output capacitance	C_{oss}		-	1347	-	
Reverse transfer capacitance	C_{rss}		-	115	-	

• Gate Charge characteristics ($T_a = 25^\circ C$)

Parameter	Symbol	Condition	Min.	Typ	Max.	Unit
Gate Resistance	R_g	$f = 1MHz$		2.3		Ω
Total gate charge	Q_g	$V_{DD} = 25V$ $I_D = 8A$ $V_{GS} = 10V$	-	89	-	nC
Gate - Source charge	Q_{gs}		-	18.6	-	
Gate - Drain charge	Q_{gd}		-	9.7	-	



Note: ① Pulse Test : Pulse width $\leq 300\mu s$, Duty cycle $\leq 2\%$;

Fig.1 Power Dissipation

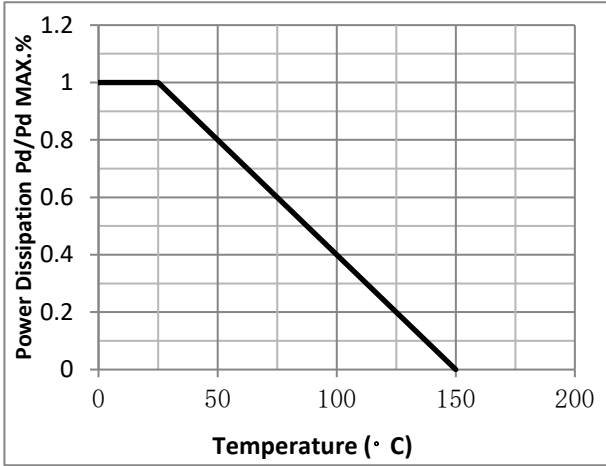

Fig.2 Typical output Characteristics

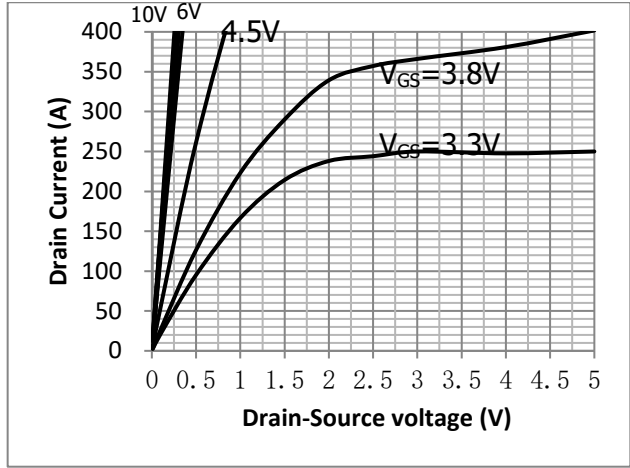

Fig.3 Threshold Voltage V.S Junction Temperature

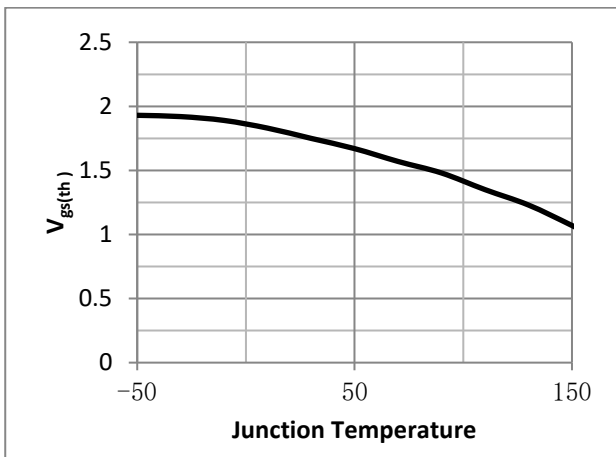

Fig.4 Resistance V.S Drain Current

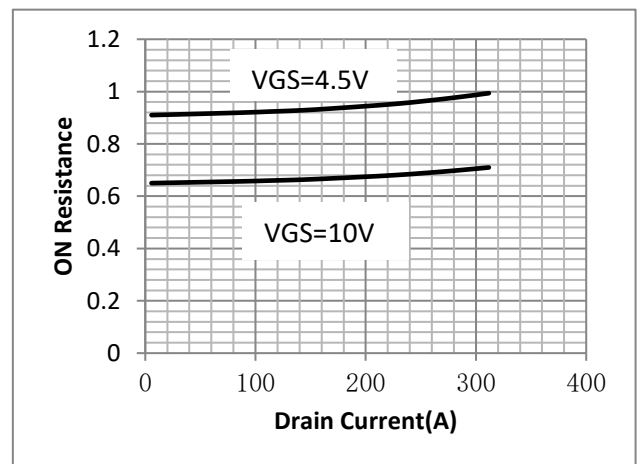

Fig.5 On-Resistance VS Gate Source Voltage

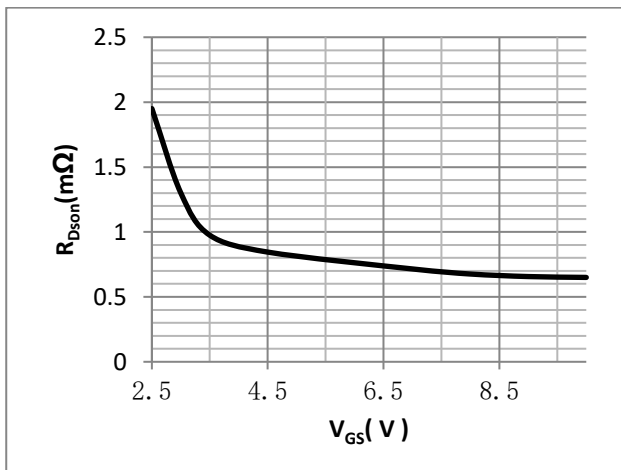

Fig.6 On-Resistance V.S Junction Temperature

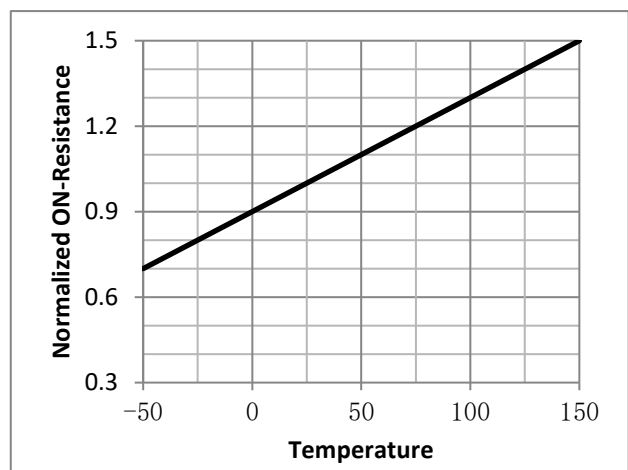



Fig.7 Gate Charge Characteristics

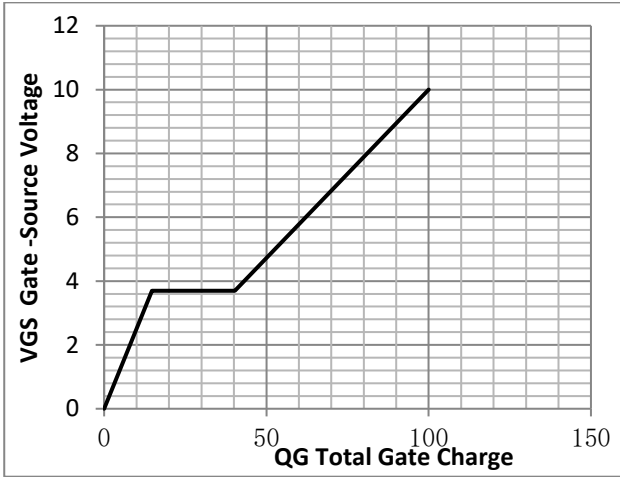

Fig.8 Capacitance vs Vds

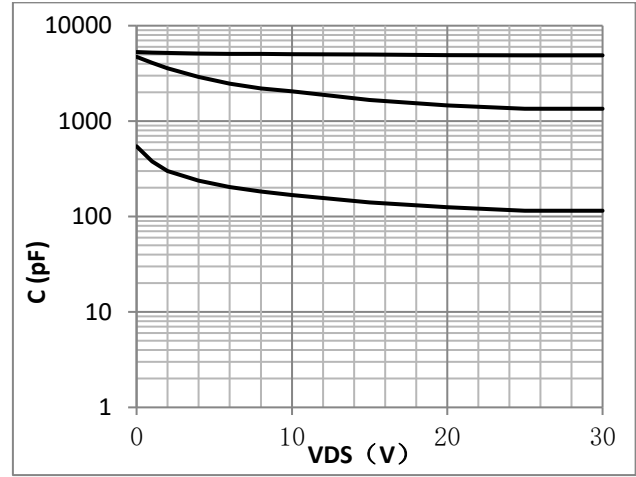

Fig.9 Diode Forward Voltage vs. Current

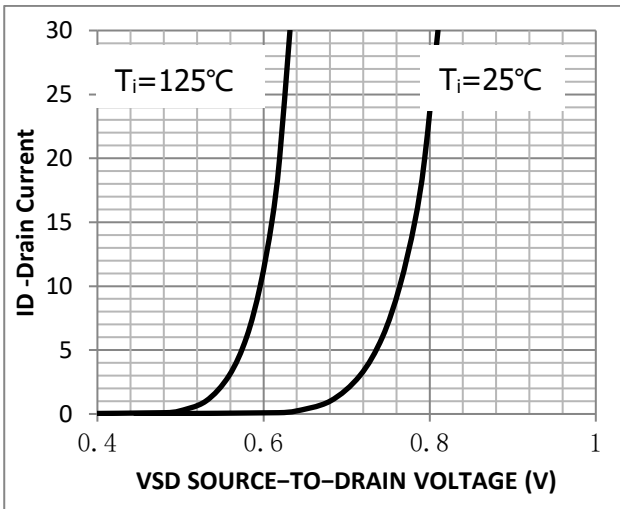

Fig.10 Capacitance Variation

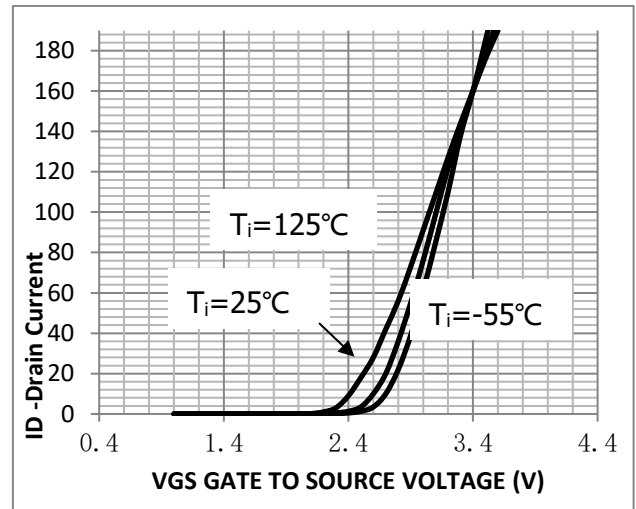

Fig.11 SOA Maximum Safe Operating Area

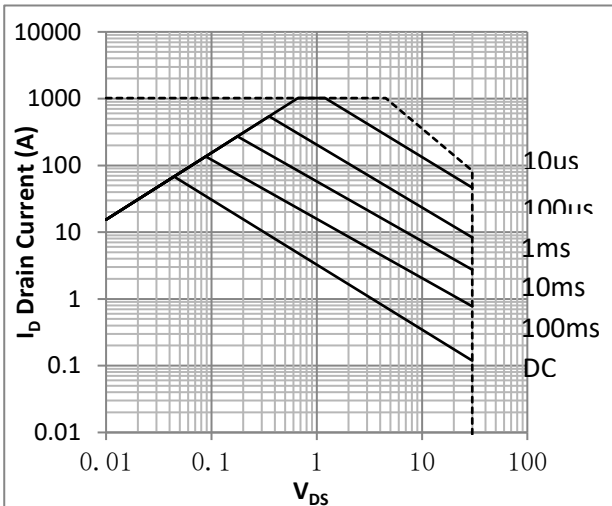

Fig.12 ID-Junction Temperature

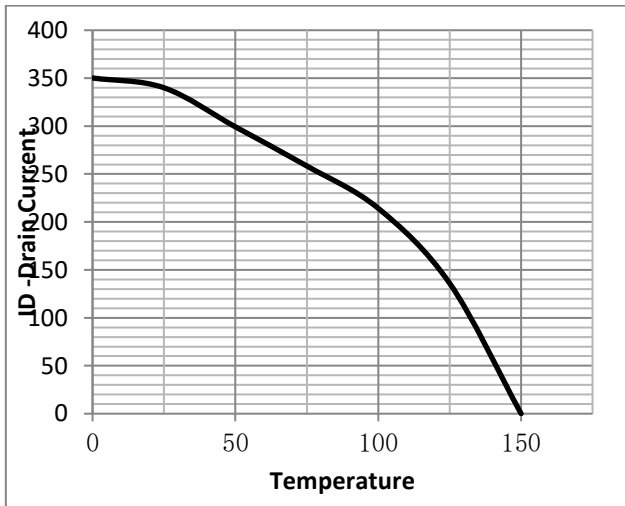

Fig.13 Switching Time Measurement Circuit

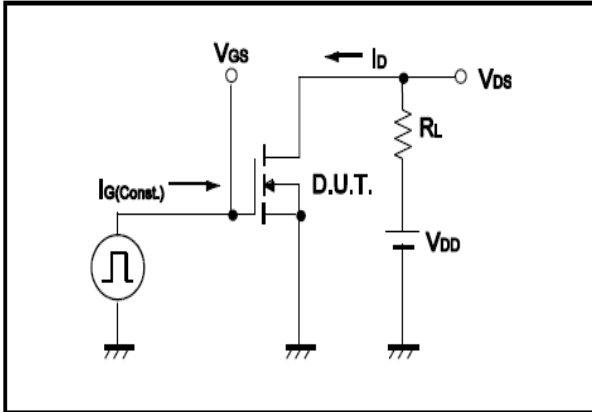

Fig.14 Gate Charge Waveform

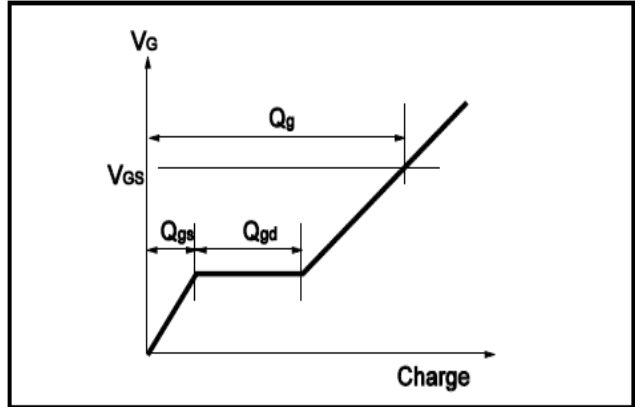

Fig.15 Resistive Switching Test Circuit

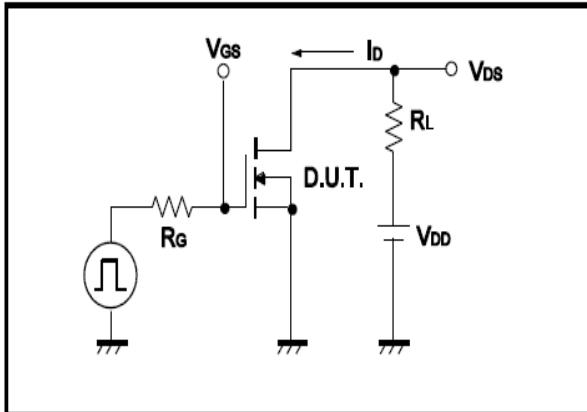

Fig.16 Resistive Switching Test Waveform

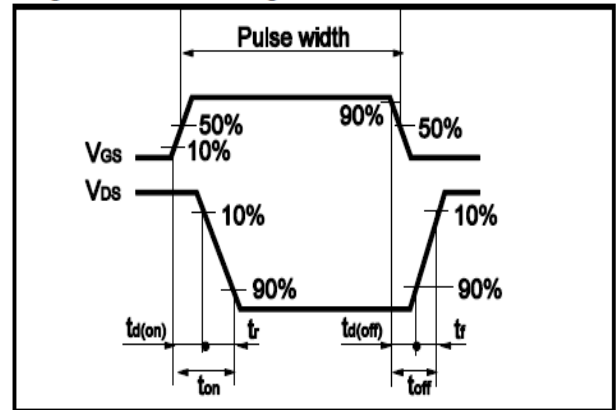

Fig.17 Avalanche Measurement Circuit

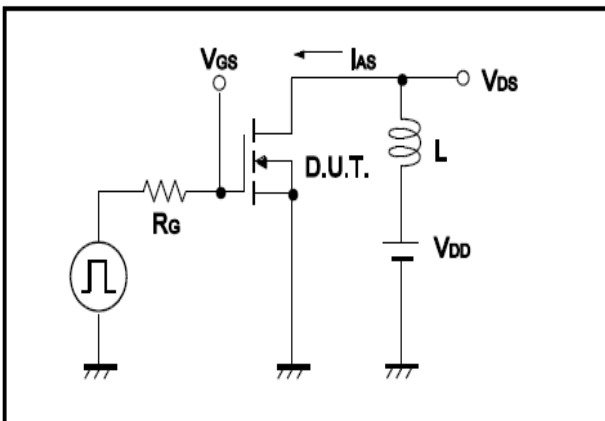
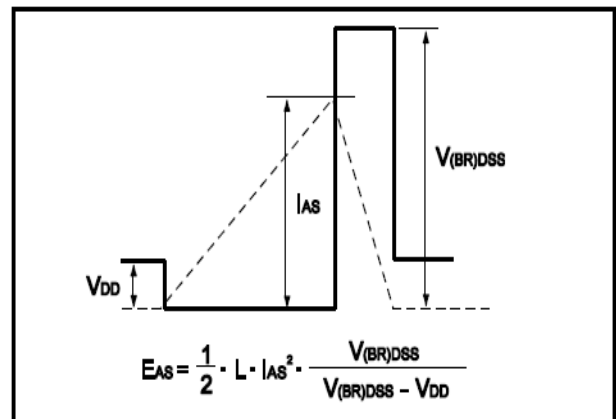

Fig.18 Avalanche Waveform





•Dimensions (DFN5x6)

Unit: mm

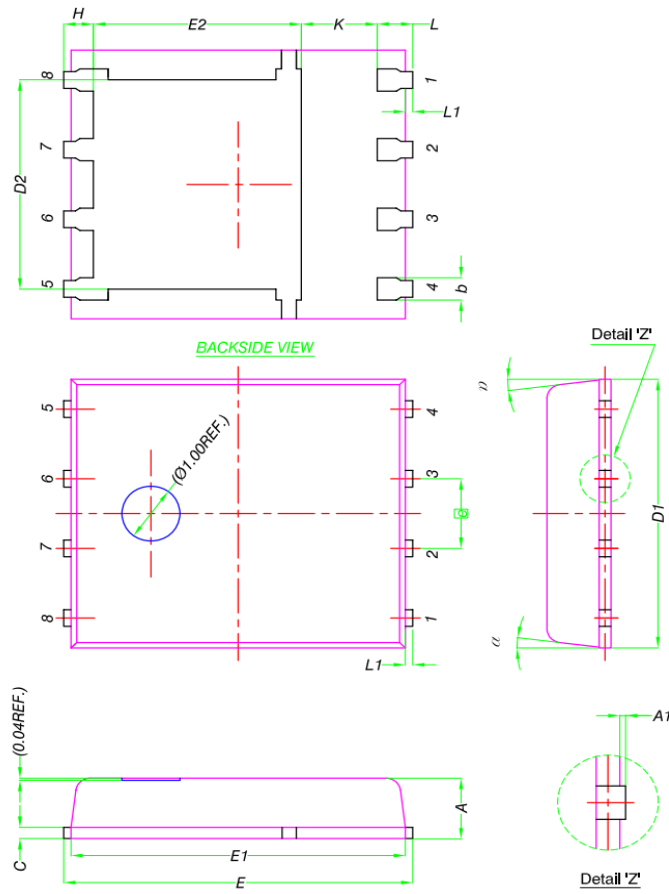

DIM.	MILLIMETERS		
	MIN.	NOM.	MAX.
A	0.90	1.00	1.10
A1	0	-	0.05
b	0.33	0.41	0.51
C	0.20	0.25	0.30
D1	4.80	4.90	5.00
D2	3.61	3.81	3.96
E	5.90	6.00	6.10
E1	5.70	5.75	5.80
E2	3.38	3.58	3.78
e	1.27 BSC		
H	0.41	0.51	0.61
K	1.10	-	-
L	0.51	0.61	0.71
L1	0.06	0.13	0.20
α	0°	-	12°