

• General Description

It combines advanced trench MOSFET technology with a low resistance package to provide extremely low $R_{DS(ON)}$.

• Features

- Advance device constructure
- Low $R_{DS(ON)}$ to minimize conduction loss
- Low Gate Charge for fast switching
- Low Thermal resistance

• Application

- Synchronous Rectification for AC-DC/DC-DC converter
- Oring switches
- Power Tools

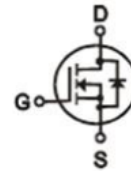
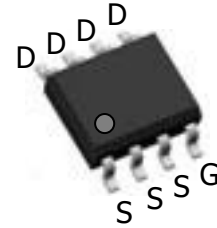
• Product Summary

 $V_{DS}=80V$
 $R_{DS(ON)} = 13m\Omega$
 $I_D = 9.5A$

SOP-8
• Ordering Information:

Part NO.	ZMS130N08S
Marking	ZMS130N08
Packing Information	REEL TAPE
Basic ordering unit (pcs)	4000

• Absolute Maximum Ratings ($T_C = 25^\circ C$)

Parameter	Symbol	Rating	Unit
Drain-Source Voltage	V_{DS}	80	V
Gate-Source Voltage	V_{GS}	± 20	V
Continuous Drain Current	$I_D @ T_C = 25^\circ C$	9.5	A
	$I_D @ T_C = 75^\circ C$	7.2	A
	$I_D @ T_C = 100^\circ C$	6.0	A
Pulsed Drain Current ①	I_{DM}	34	A
Total Power Dissipation	$P_D @ T_C = 25^\circ C$	70	W
Total Power Dissipation	$P_D @ T_A = 25^\circ C$	2.5	W
Operating Junction Temperature	T_J	-55 to 150	$^\circ C$
Storage Temperature	T_{STG}	-55 to 150	$^\circ C$
Single Pulse Avalanche Energy	E_{AS}	40	mJ

•Thermal resistance

Parameter	Symbol	Min.	Typ.	Max.	Unit
Thermal resistance, junction - case	R_{thJC}	-	-	1.7	° C/W
Thermal resistance, junction - ambient	R_{thJA}	-	-	50	° C/W
Soldering temperature, wavesoldering for 10s	T_{sold}	-	-	265	° C

•Electronic Characteristics

Parameter	Symbol	Condition	Min.	Typ	Max.	Unit
Drain-Source Breakdown Voltage	BV_{DSS}	$V_{GS} = 0V, I_D = 250\mu A$	80			V
Gate Threshold Voltage	$V_{GS(TH)}$	$V_{GS} = V_{DS}, I_D = 250\mu A$	1.2		2.5	V
Drain-Source Leakage Current	I_{DSS}	$V_{DS} = 80V, V_{GS} = 0V$			1.0	μA
Gate- Source Leakage Current	I_{GSS}	$V_{GS} = \pm 20V, V_{DS} = 0V$			± 100	nA
Static Drain-source On Resistance	$R_{DS(ON)}$	$V_{GS} = 10V, I_D = 10A$		13	16	m Ω
		$V_{GS} = 4.5V, I_D = 5A$		15	18	m Ω
Forward Transconductance	g_{FS}	$V_{DS} = 25V, I_D = 10A$		14		S
Source-drain voltage	V_{SD}	$I_S = 10A$			1.28	V

•Electronic Characteristics

Parameter	Symbol	Condition	Min.	Typ	Max.	Unit
Input capacitance	C_{iss}	$f = 1MHz$	-	890	-	pF
Output capacitance	C_{oss}		-	423	-	
Reverse transfer capacitance	C_{rss}		-	8.1	-	

•Gate Charge characteristics($T_a = 25^\circ C$)

Parameter	Symbol	Condition	Min.	Typ	Max.	Unit
Total gate charge	Q_g	$V_{DD} = 25V$	-	11	-	nC
Gate - Source charge	Q_{gs}	$I_D = 8A$	-	2.0	-	
Gate - Drain charge	Q_{gd}	$V_{GS} = 10V$	-	1.2	-	

Note: ① Pulse Test : Pulse width $\leq 300\mu s$, Duty cycle $\leq 2\%$;

Fig.1 Gate-Charge Characteristics

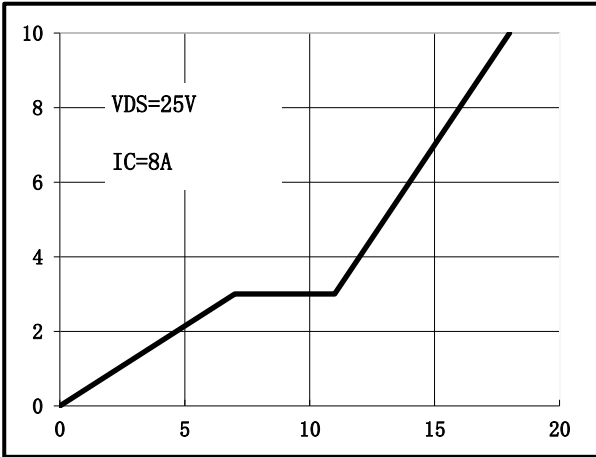

Fig.2 Capacitance Characteristics

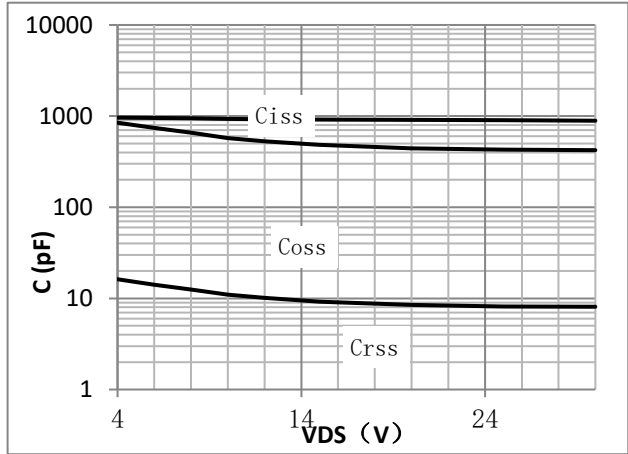

Fig.3 Power Dissipation

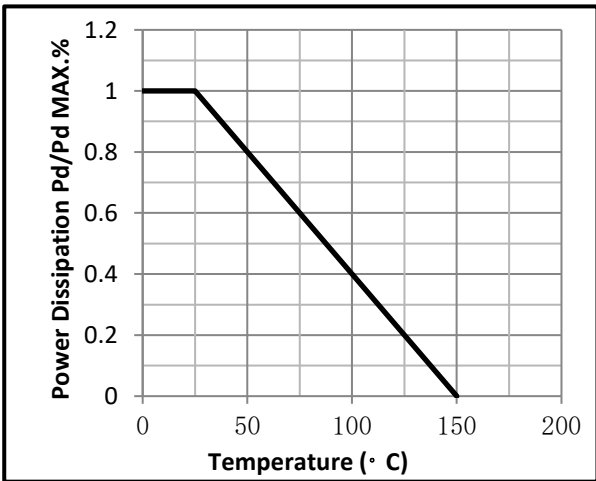

Fig.4 Typical output Characteristics

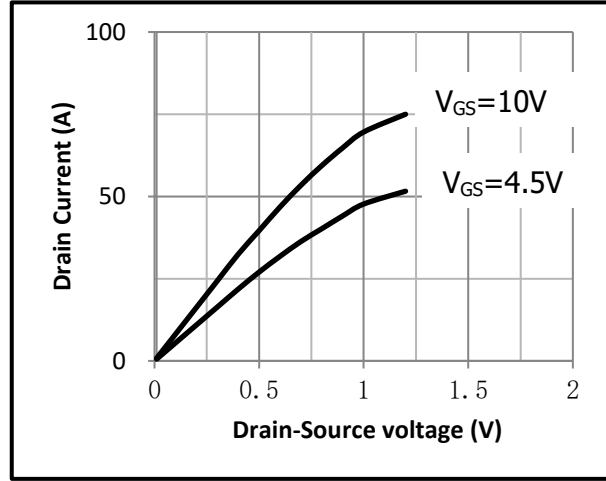

Fig.5 Threshold Voltage V.S Junction Temperature

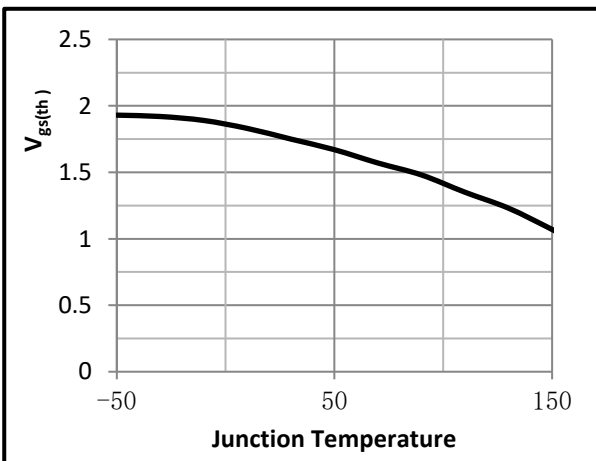

Fig.6 Resistance V.S Drain Current

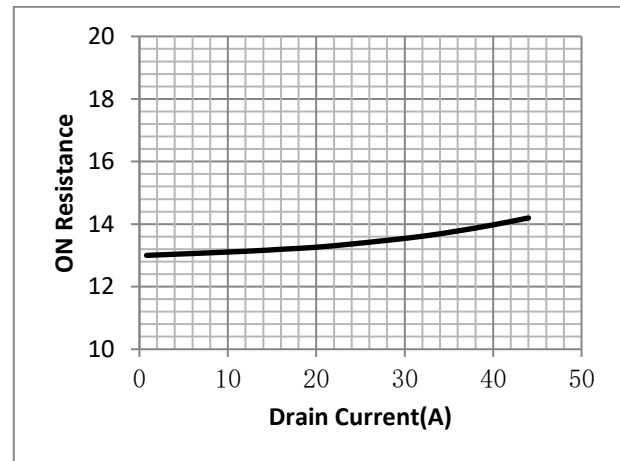

Fig.7 On-Resistance VS Gate Source Voltage

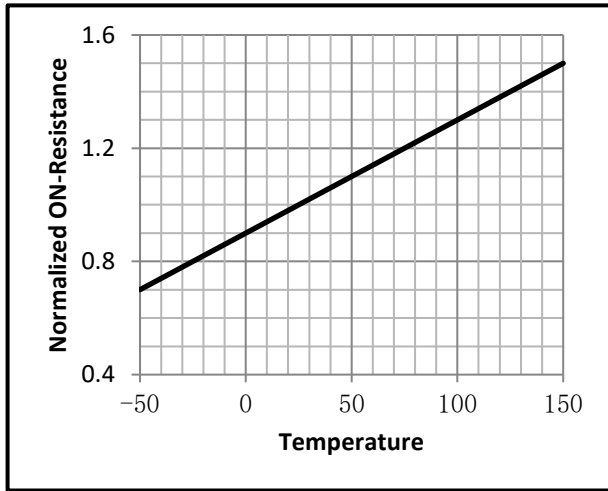

Fig.8 On-Resistance V.S Junction Temperature

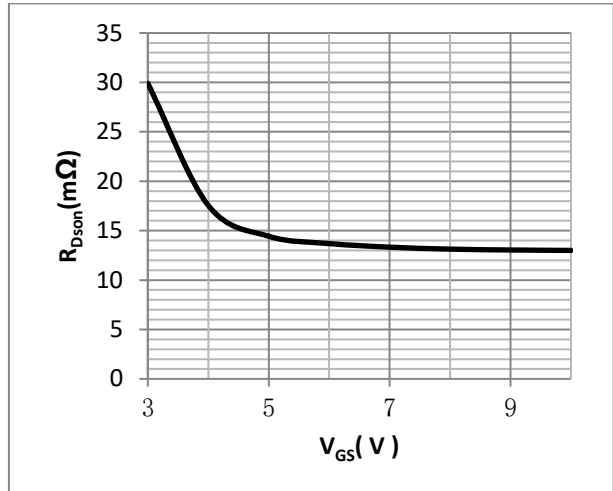

Fig.9 Switching Time Measurement Circuit

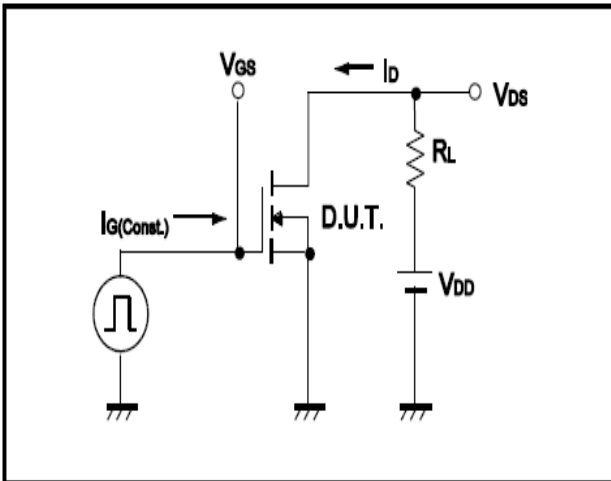

Fig.10 Gate Charge Waveform

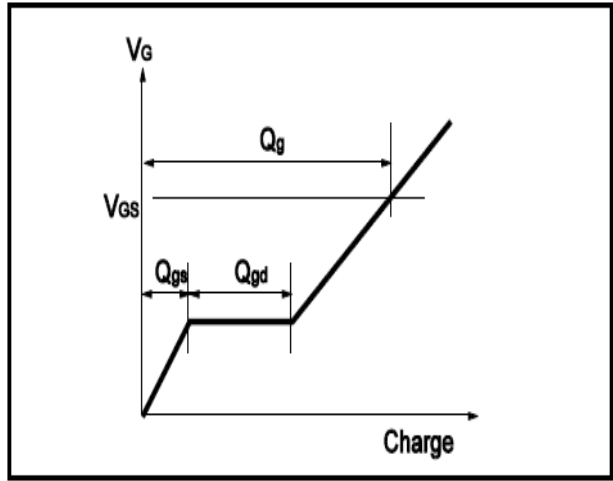

Fig.11 Switching Time Measurement Circuit

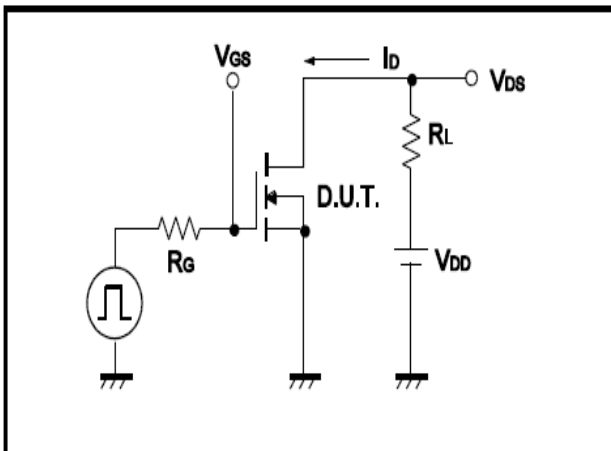
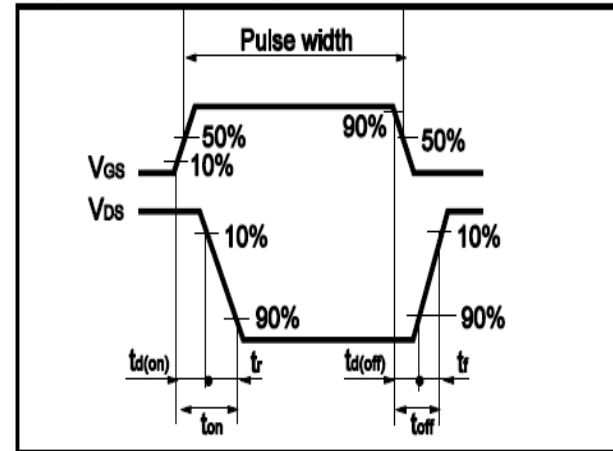

Fig.12 Gate Charge Waveform



●Dimensions(SOP8)

Unit: mm

SYMBOL	min	TYP	max	SYMBOL	min		max
A	4.80		5.25	C	1.30		1.75
A1	0.37		0.49	C1	0.55		0.75
A2		1.27		C2	0.55		0.65
A3		0.41		C3	0.05		0.20
B	5.80		6.20	C4	0.10	0.20	0.23
B1	3.80		4.00	D		1.05	
B2		5.00		D1	0.40		0.62

