

**General Description**

The ZMD68606S combines advanced trench MOSFET technology with a low resistance package to provide extremely low  $R_{DS(ON)}$ .

**Features**

- Advance device constructure
- Low  $R_{DS(ON)}$  to minimize conduction loss
- Low Gate Charge for fast switching
- Low Thermal resistance

**Application**

- Synchronous Rectification for AC-DC/DC-DC converter
- Oring switches
- Power Tools

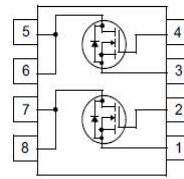
**Product Summary**

$V_{DS1} = 60V$   
 $V_{DS2} = 60V$   
 $R_{DS(ON)1} = 10m\Omega$   
 $R_{DS(ON)2} = 10m\Omega$   
 $I_{D1} = 10A$   
 $I_{D2} = 10A$

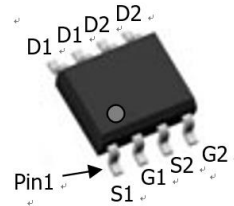
**SOP-8**
**Ordering Information:**

Part NO.	ZMD68606S
Marking	ZMD68606
Packing Information	REEL TAPE
Basic ordering unit (pcs)	4000

**Absolute Maximum Ratings ( $T_C = 25^\circ C$ )**

Parameter	Symbol	Rating	Unit
Drain-Source Voltage	$V_{DS}$	65	V
Gate-Source Voltage	$V_{GS}$	$\pm 20$	V
Continuous Drain Current	$I_D @ T_C = 25^\circ C$	10	A
	$I_D @ T_C = 75^\circ C$	7.6	A
	$I_D @ T_C = 100^\circ C$	6.3	A
Pulsed Drain Current ①	$I_{DM}$	30	A
Total Power Dissipation	$P_D @ T_C = 25^\circ C$	3.6	W
Total Power Dissipation	$P_D @ T_A = 25^\circ C$	0.69	W
Operating Junction Temperature	$T_J$	-55 to 150	$^\circ C$
Storage Temperature	$T_{STG}$	-55 to 150	$^\circ C$
Single Pulse Avalanche Energy @ $L = 0.1mH$	$E_{AS}$	35	mJ



## ● Thermal resistance

Parameter	Symbol	Min.	Typ.	Max.	Unit
Thermal resistance, junction - case	$R_{thJC}$	-	-	34	° C/W
Thermal resistance, junction - ambient	$R_{thJA}$	-	-	180	° C/W
Soldering temperature, wavesoldering for 10s	$T_{sold}$	-	-	265	° C

## ● Electronic Characteristics

Parameter	Symbol	Condition	Min.	Typ	Max.	Unit
Drain-Source Breakdown Voltage	$BV_{DSS}$	$V_{GS} = 0V, I_D = 250\mu A$	65			V
Gate Threshold Voltage	$V_{GS(TH)}$	$V_{GS} = V_{DS}, I_D = 250\mu A$	1.2		2.5	V
Drain-Source Leakage Current	$I_{DSS}$	$V_{DS} = 60V, V_{GS} = 0V$			1.0	$\mu A$
Gate- Source Leakage Current	$I_{GSS}$	$V_{GS} = \pm 20V, V_{DS} = 0V$			$\pm 100$	nA
Static Drain-source On Resistance	$R_{DS(ON)}$	$V_{GS} = 10V, I_D = 10A$		10	13	m $\Omega$
		$V_{GS} = 4.5V, I_D = 5A$		13	17	m $\Omega$
Forward Transconductance	$g_{FS}$	$V_{DS} = 25V, I_D = 10A$		14		S
Source-drain voltage	$V_{SD}$	$I_S = 10A$			1.28	V

## ● Electronic Characteristics

Parameter	Symbol	Condition	Min.	Typ	Max.	Unit
Input capacitance	$C_{iss}$	$f = 1MHz$	-	960	-	pF
Output capacitance	$C_{oss}$		-	460	-	
Reverse transfer capacitance	$C_{rss}$		-	9	-	

● Gate Charge characteristics ( $T_a = 25^\circ C$ )

Parameter	Symbol	Condition	Min.	Typ	Max.	Unit
Total gate charge	$Q_g$	$V_{DD} = 25V$	-	11	-	nC
Gate - Source charge	$Q_{gs}$	$I_D = 8A$	-	2.2	-	
Gate - Drain charge	$Q_{gd}$	$V_{GS} = 10V$	-	1.4	-	

Note: ① Pulse Test : Pulse width  $\leq 300\mu s$ , Duty cycle  $\leq 2\%$  ;

Fig.1 Gate-Charge Characteristics

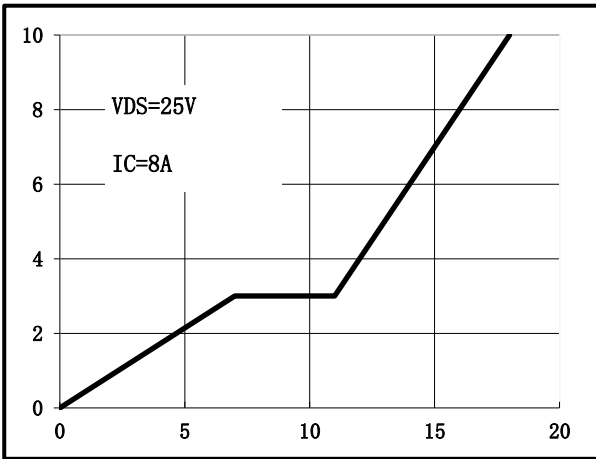

Fig.2 Capacitance Characteristics

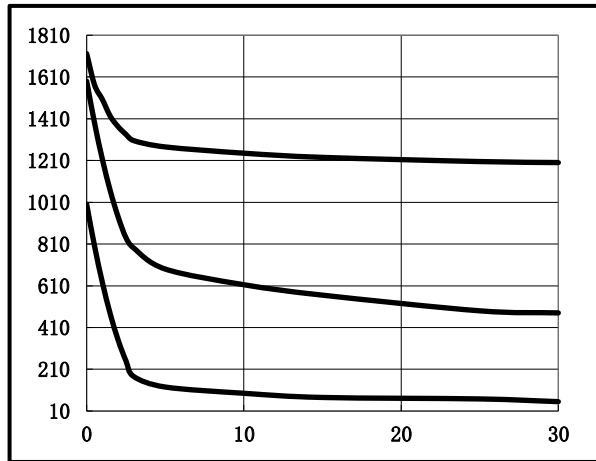

Fig.3 Power Dissipation

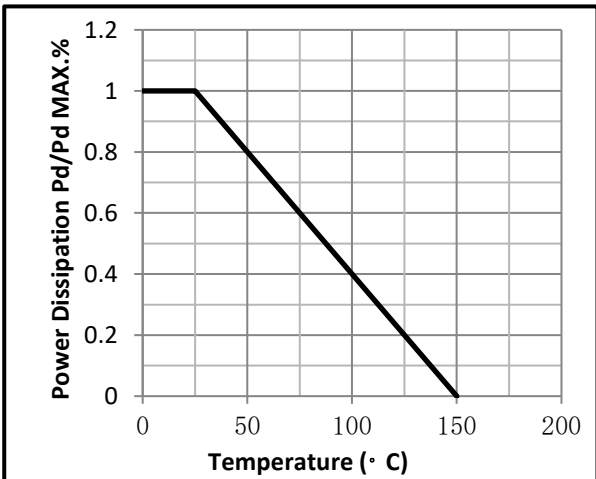

Fig.4 Typical output Characteristics

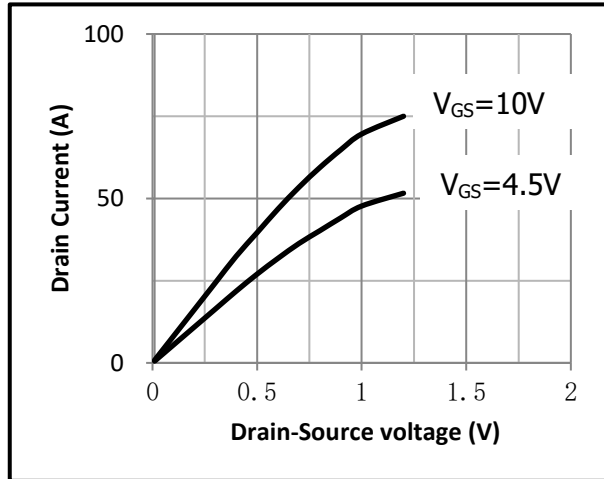

Fig.5 Threshold Voltage V.S Junction Temperature

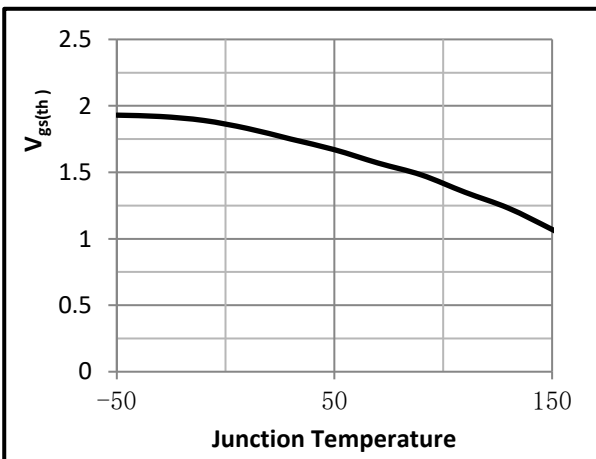

Fig.6 Resistance V.S Drain Current

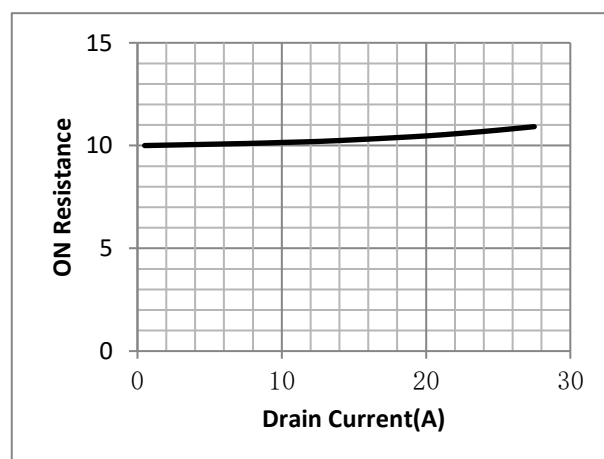

Fig.7 On-Resistance VS Gate Source Voltage

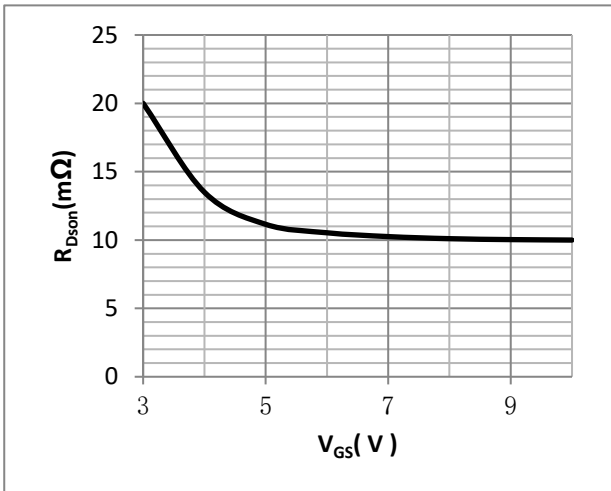

Fig.8 On-Resistance V.S Junction Temperature

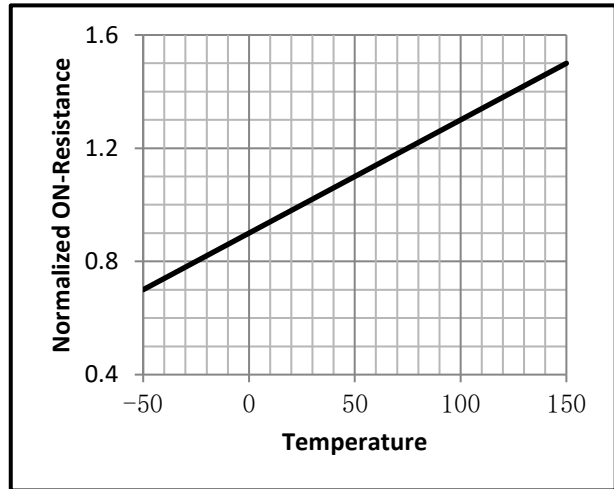

Fig.9 Switching Time Measurement Circuit

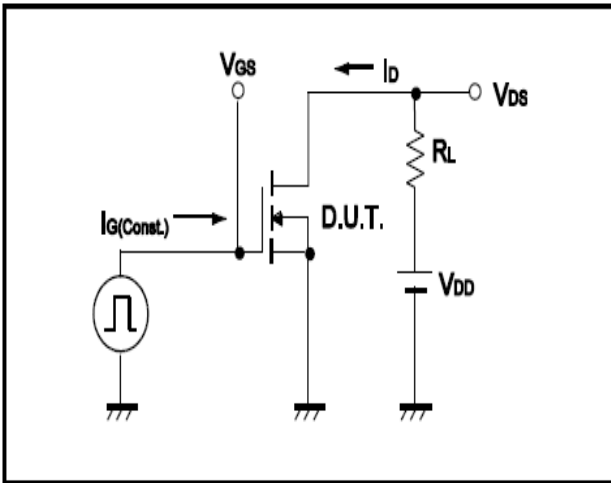

Fig.10 Gate Charge Waveform

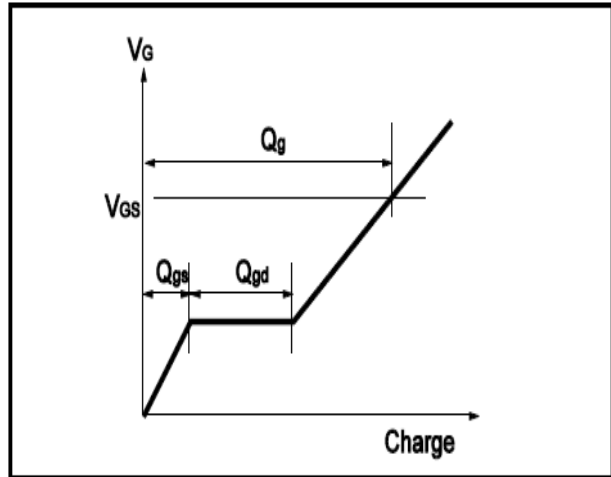

Fig.11 Switching Time Measurement Circuit

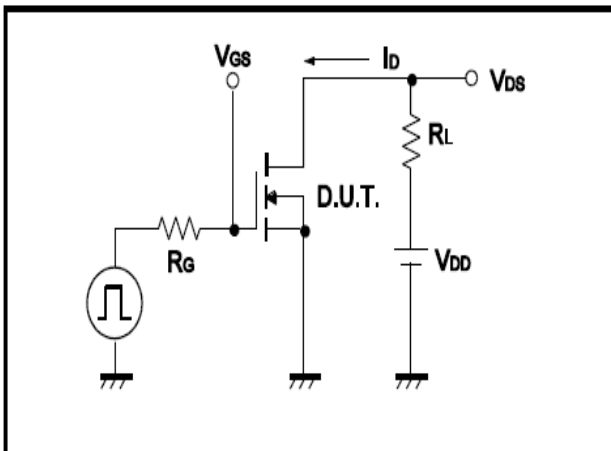
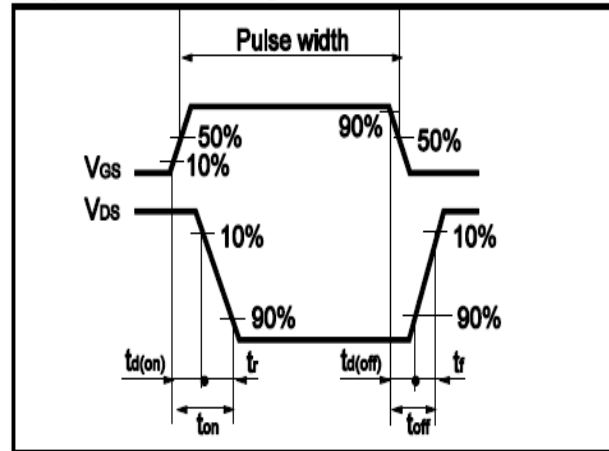

Fig.12 Gate Charge Waveform



●Dimensions(SOP8)

Unit: mm

SYMBOL	min	TYP	max	SYMBOL	min		max
A	4.80		5.25	C	1.30		1.75
A1	0.37		0.49	C1	0.55		0.75
A2		1.27		C2	0.55		0.65
A3		0.41		C3	0.05		0.20
B	5.80		6.20	C4	0.10	0.20	0.23
B1	3.80		4.10	D		1.05	
B2		5.00		D1	0.40		0.62

