

**• General Description**

The ZM430P06S combines advanced trench MOSFET technology with a low resistance package to provide extremely low  $R_{DS(ON)}$ .

**• Features**

- Advance high cell density Trench technology
- Low  $R_{DS(ON)}$  to minimize conductive loss
- Low Gate Charge for fast switching
- Low Thermal resistance

**• Application**

- MB/VGA Vcore
- SMPS 2<sup>nd</sup> Synchronous Rectifier
- POL application
- BLDC Motor driver

**• Product Summary**

$V_{DS} = -60V$

$R_{DS(ON)} = 43m\Omega$

$I_D = -6.2A$

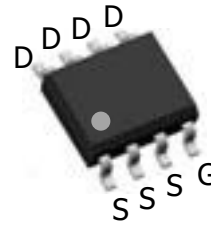
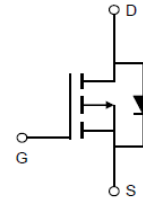

SOP-8

**• Ordering Information:**

Part NO.	ZM430P06S
Marking	ZM430P06
Packing Information	REEL TAPE
Basic ordering unit (pcs)	4000

**• Absolute Maximum Ratings ( $T_C = 25^\circ C$ )**

Parameter	Symbol	Rating	Unit
Drain-Source Voltage	$V_{DS}$	-60	V
Gate-Source Voltage	$V_{GS}$	$\pm 20$	V
Continuous Drain Current	$I_D @ T_C = 25^\circ C$	-6.2	A
	$I_D @ T_C = 75^\circ C$	-4.7	A
	$I_D @ T_C = 100^\circ C$	-3.9	A
Pulsed Drain Current <sup>①</sup>	$I_{DM}$	-18.6	A
Total Power Dissipation <sup>②</sup>	$P_D @ T_C = 25^\circ C$	3.6	W
Total Power Dissipation	$P_D @ T_A = 25^\circ C$	0.69	W
Operating Junction Temperature	$T_J$	-55 to 150	$^\circ C$
Storage Temperature	$T_{STG}$	-55 to 150	$^\circ C$
Single Pulse Avalanche Energy	$E_{AS}$	55	mJ

**•Thermal resistance**

Parameter	Symbol	Min.	Typ.	Max.	Unit
Thermal resistance, junction - case <sup>②</sup>	R <sub>thJC</sub>	-	-	34	° C/W
Thermal resistance, junction - ambient	R <sub>thJA</sub>	-	-	180	° C/W
Soldering temperature, wavesoldering for 10s	T <sub>sold</sub>	-	-	265	° C

**•Electronic Characteristics**

Parameter	Symbol	Condition	Min.	Typ	Max.	Unit
Drain-Source Breakdown Voltage	BV <sub>DSS</sub>	V <sub>GS</sub> =0V, I <sub>D</sub> =-250uA	-60			V
Gate Threshold Voltage	V <sub>GS(TH)</sub>	V <sub>GS</sub> =V <sub>DS</sub> , I <sub>D</sub> =-250uA	-1.2		-2.5	V
Drain-Source Leakage Current	I <sub>DSS</sub>	V <sub>DS</sub> =-60V, V <sub>GS</sub> =0V			-1.0	uA
Gate- Source Leakage Current	I <sub>GSS</sub>	V <sub>GS</sub> =±20V, V <sub>DS</sub> =0V			±100	nA
Static Drain-source On Resistance	R <sub>DS(ON)</sub>	V <sub>GS</sub> =-10V, I <sub>D</sub> =-5A		43	50	mΩ
		V <sub>GS</sub> =-4.5V, I <sub>D</sub> =-3A		65	75	mΩ
Forward Transconductance	g <sub>FS</sub>	V <sub>DS</sub> =-10V, I <sub>D</sub> =-5A		9		s
Source-drain voltage	V <sub>SD</sub>	I <sub>S</sub> =-5A			1.28	V

**•Electronic Characteristics**

Parameter	Symbol	Condition	Min.	Typ	Max.	Unit
Input capacitance	C <sub>iss</sub>	f = 1MHz V <sub>DS</sub> =4.5V	-	2050	-	pF
Output capacitance	C <sub>oss</sub>		-	127	-	
Reverse transfer capacitance	C <sub>rss</sub>		-	93	-	

**•Gate Charge characteristics(T<sub>a</sub> = 25°C)**

Parameter	Symbol	Condition	Min.	Typ	Max.	Unit
Total gate charge	Q <sub>g</sub>	V <sub>DD</sub> =25V	-	34	-	nC
Gate - Source charge	Q <sub>gs</sub>	I <sub>D</sub> = 4A	-	4.6	-	
Gate - Drain charge	Q <sub>gd</sub>	V <sub>GS</sub> = 10V	-	5.9	-	

Note: ① Pulse Test : Pulse width ≤ 300μs, Duty cycle ≤ 2% ;

② Device mounted on FR-4 substrate PC board, 2oz copper, with thermal bias to bottom layer 1inch square copper plate;

Fig.1 Gate-Charge Characteristics

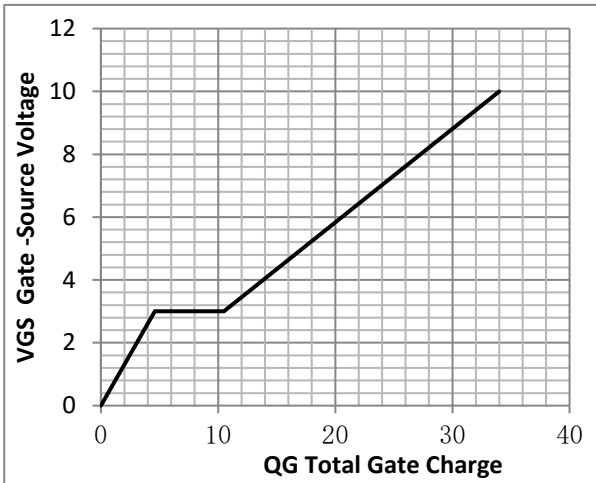

Fig.2 Capacitance Characteristics

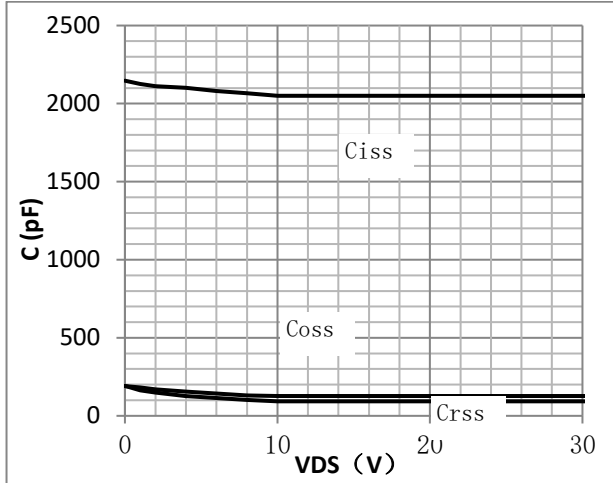

Fig.3 Power Dissipation Derating Curve

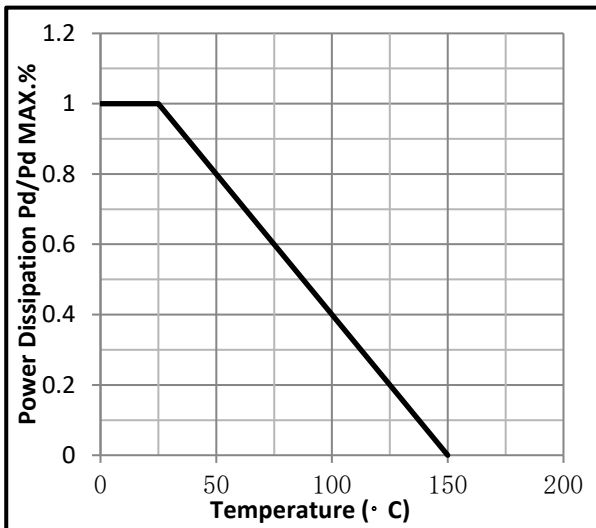

Fig.4 Typical output Characteristics

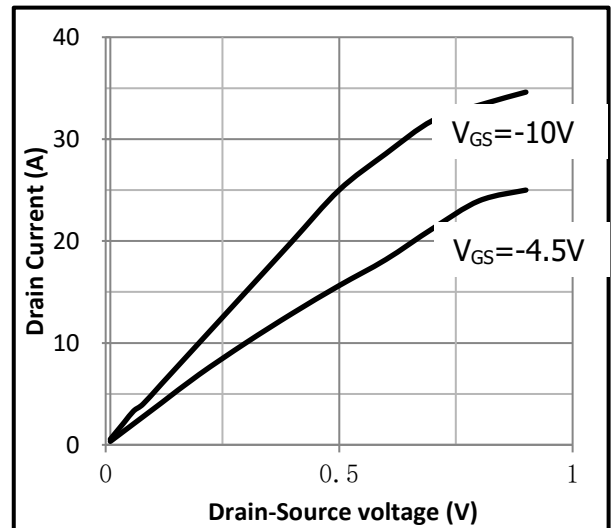

Fig.5 Threshold Voltage V.S Junction Temperature

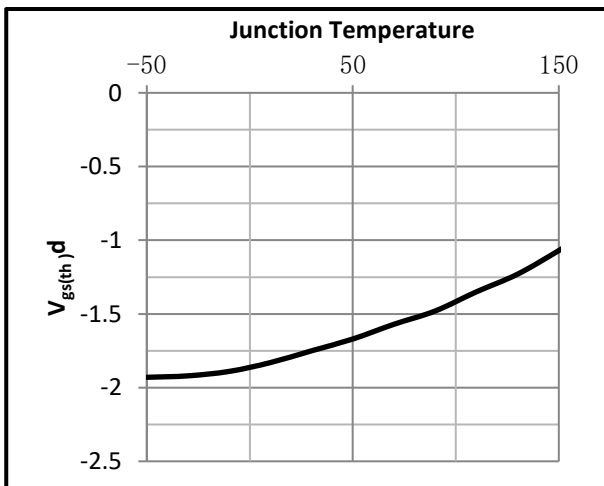

Fig.6 Resistance V.S Drain Current

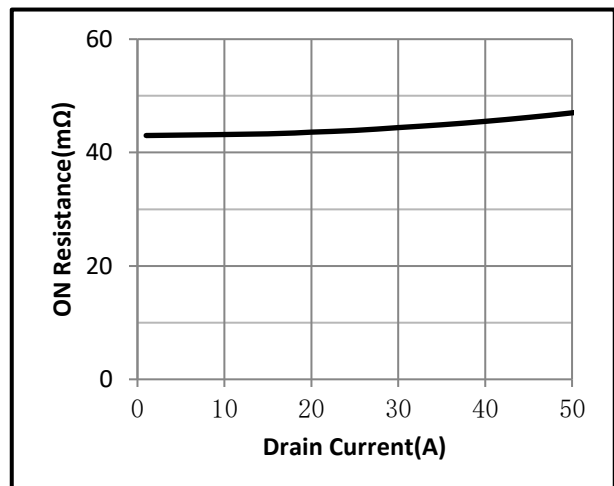

Fig.7 On-Resistance VS Gate Source Voltage

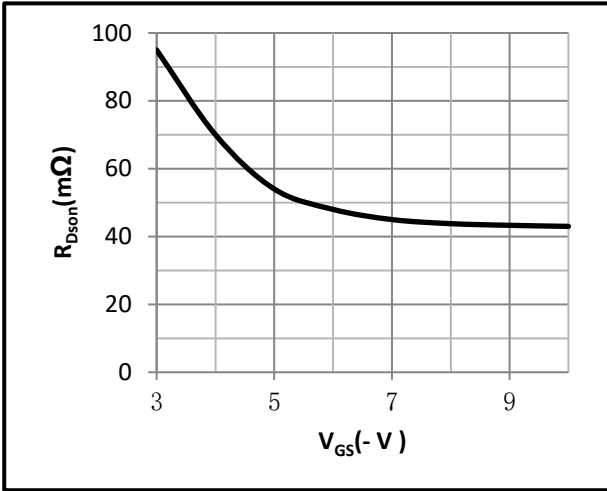

Fig.8 On-Resistance V.S Junction Temperature

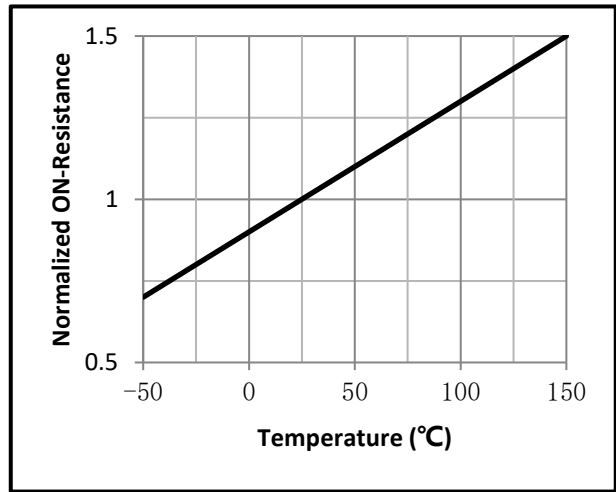

Fig.9 Safe Operating Area

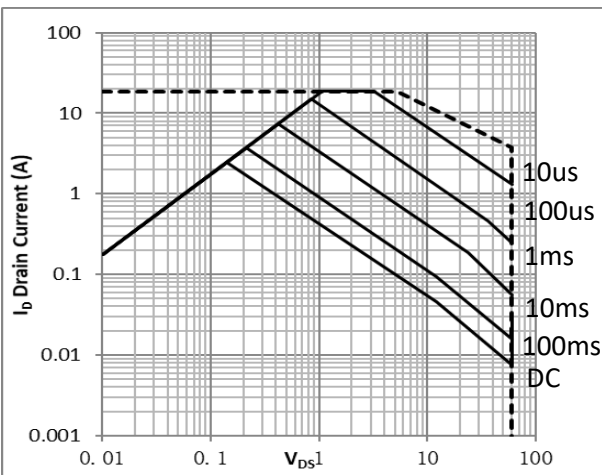

Fig.10 Drain Current V.S Junction Temperature

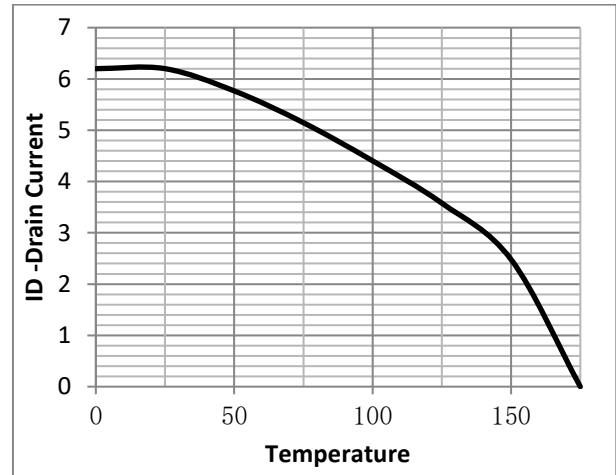

Fig.11 Switching Time Measurement Circuit

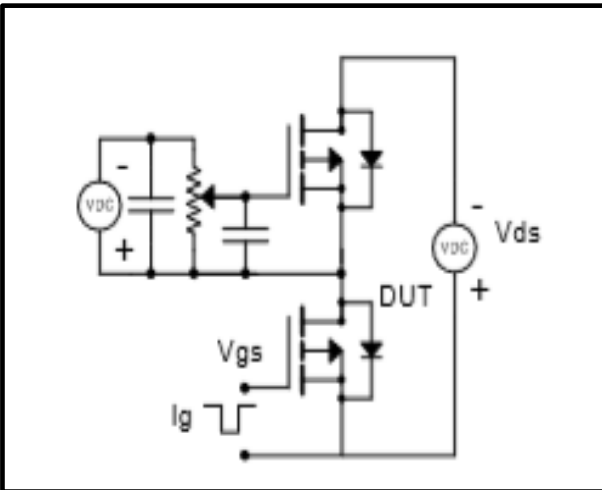

Fig.12 Gate Charge Waveform

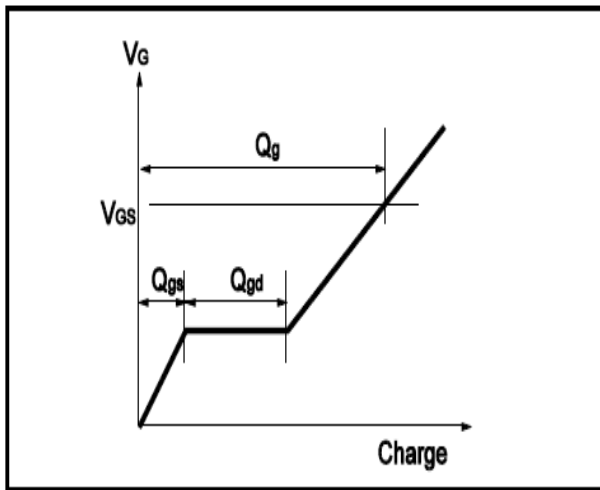

Fig.13 Switching Time Measurement Circuit

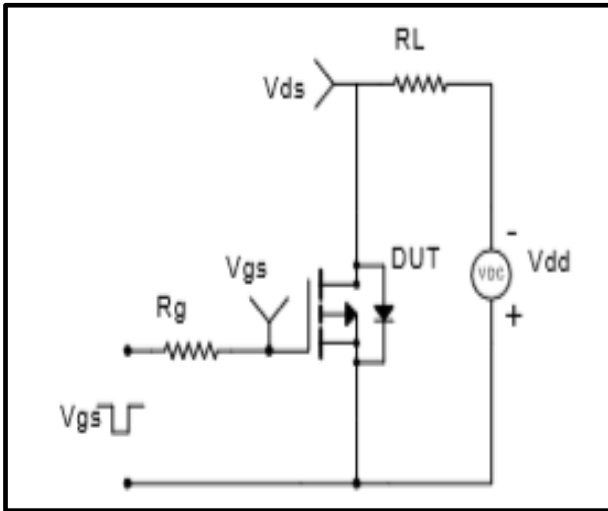
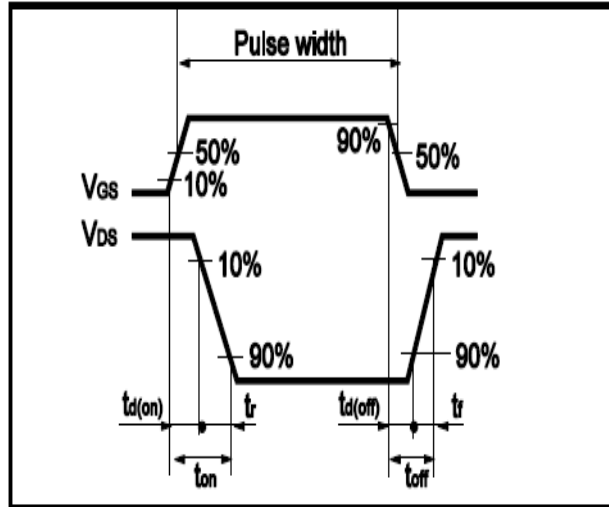

Fig.14 Gate Charge Waveform



●Dimensions(SOP8)

Unit: mm

SYMBOL	min	TYP	max	SYMBOL	min		max
A	4.80		5.25	C	1.30		1.75
A1	0.37		0.49	C1	0.55		0.75
A2		1.27		C2	0.55		0.65
A3		0.41		C3	0.05		0.20
B	5.80		6.20	C4	0.10	0.20	0.23
B1	3.80		4.10	D		1.05	
B2		5.00		D1	0.40		0.62

