

**• General Description**

The ZM045N03M combines advanced trench MOSFET technology with a low resistance package to provide extremely low  $R_{DS(ON)}$ . This device is ideal for load switch and battery protection applications.

**• Features**

- Advance high cell density Trench technology
- Low  $R_{DS(ON)}$  to minimize conductive loss
- Low Gate Charge for fast switching
- Low Thermal resistance

**• Application**

- MB/VGA Vcore
- SMPS 2<sup>nd</sup> Synchronous Rectifier
- POL application
- BLDC Motor driver

**• Ordering Information:**

Part NO.	ZM045N03M
Marking	045N03
Packing Information	REEL TAPE
Basic ordering unit (pcs)	5000

**• Absolute Maximum Ratings ( $T_C = 25^\circ\text{C}$ )**

Parameter	Symbol	Rating	Unit
Drain-Source Voltage	$V_{DS}$	30	V
Gate-Source Voltage	$V_{GS}$	$\pm 20$	V
Continuous Drain Current	$I_D @ T_C = 25^\circ\text{C}$	60	A
	$I_D @ T_C = 75^\circ\text{C}$	45	A
	$I_D @ T_C = 100^\circ\text{C}$	38	A
Pulsed Drain Current ①	$I_{DM}$	150	A
Total Power Dissipation	$P_D @ T_C = 25^\circ\text{C}$	43	W
Total Power Dissipation	$P_D @ T_A = 25^\circ\text{C}$	2.3	W
Operating Junction Temperature	$T_J$	-55 to 150	$^\circ\text{C}$
Storage Temperature	$T_{STG}$	-55 to 150	$^\circ\text{C}$
Single Pulse Avalanche Energy	$E_{AS}$	260	mJ

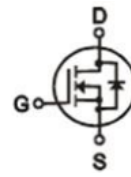
**• Product Summary**

$V_{DS} = 30V$

$R_{DS(ON)} = 4.5m\Omega$

$I_D = 60A$

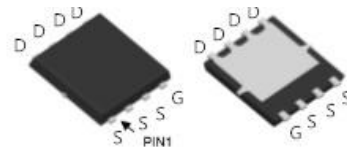

DFN3 x 3

**•Thermal resistance**

Parameter	Symbol	Min.	Typ.	Max.	Unit
Thermal resistance, junction - case	$R_{thJC}$	-	-	2.9	$^{\circ}C/W$
Thermal resistance, junction - ambient	$R_{thJA}$	-	-	54	$^{\circ}C/W$
Soldering temperature, wavesoldering for 10s	$T_{sold}$	-	-	265	$^{\circ}C$

**•Electronic Characteristics**

Parameter	Symbol	Condition	Min.	Typ	Max.	Unit
Drain-Source Breakdown Voltage	$BV_{DSS}$	$V_{GS}=0V, I_D=250\mu A$	30			V
Gate Threshold Voltage	$V_{GS(TH)}$	$V_{GS}=V_{DS}, I_D=250\mu A$	1.2		2.5	V
Drain-Source Leakage Current	$I_{DSS}$	$V_{DS}=30V, V_{GS}=0V$			1.0	$\mu A$
Gate- Source Leakage Current	$I_{GSS}$	$V_{GS}=\pm 20V, V_{DS}=0V$			$\pm 100$	nA
Static Drain-source On Resistance	$R_{DS(ON)}$	$V_{GS}=10V, I_D=20A$		4.5	6.0	$m\Omega$
		$V_{GS}=4.5V, I_D=10A$		7.0	9.0	$m\Omega$
Forward Trans conductance	$g_{FS}$	$V_{DS}=25V, I_D=10A$		16		S
Source-drain voltage	$V_{SD}$	$I_S=20A$		0.8	1.28	V

**•Dynamic Characteristics**

Parameter	Symbol	Condition	Min.	Typ	Max.	Unit
Input capacitance	$C_{iss}$	$f = 1MHz$	-	1500	-	pF
Output capacitance	$C_{oss}$		-	280	-	
Reverse transfer capacitance	$C_{rss}$		-	140	-	
Total gate charge	$Q_g$	$V_{DD}=25V$ $I_D=8A$ $V_{GS}=10V$	-	16	-	nC
Gate - Source charge	$Q_{gs}$		-	5	-	
Gate - Drain charge	$Q_{gd}$		-	8	-	
Turn-ON Delay time	$t_{D(on)}$	$V_{GS}=10V$ $V_{DS}=15V$ $R_G=3.3\Omega$ $I_D=15A$		7.5		ns
Turn-ON Rise time	$t_r$			14		ns
Turn-Off Delay time	$t_{D(off)}$			35		ns
Turn-Off Fall time	$t_f$			10		ns

Note: ① Pulse Test : Pulse width  $\leq 300\mu s$ , Duty cycle  $\leq 2\%$  ;

Fig.1 Power Dissipation

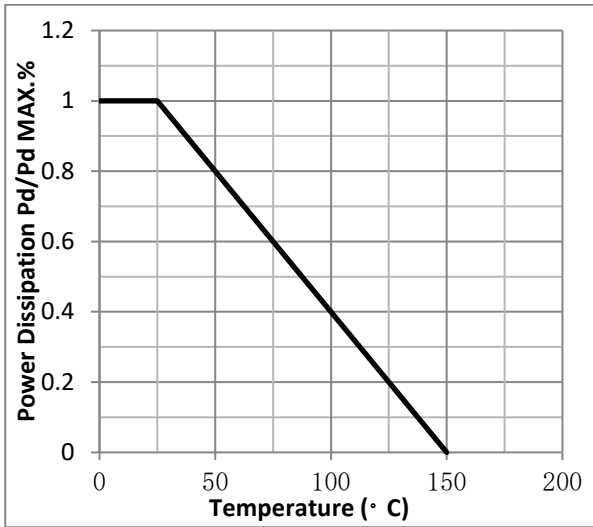

Fig.2 Typical output Characteristics

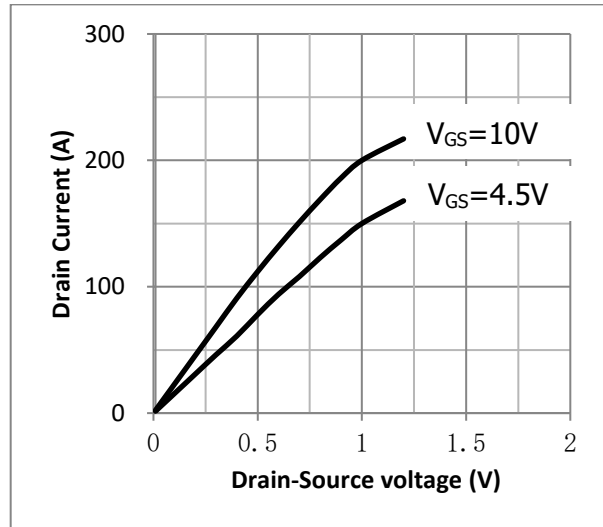

Fig.3 Threshold Voltage V.S Junction Temperature

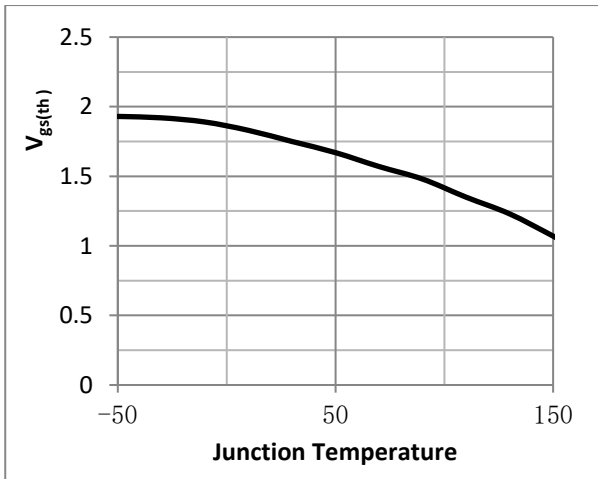

Fig.4 Resistance V.S Drain Current

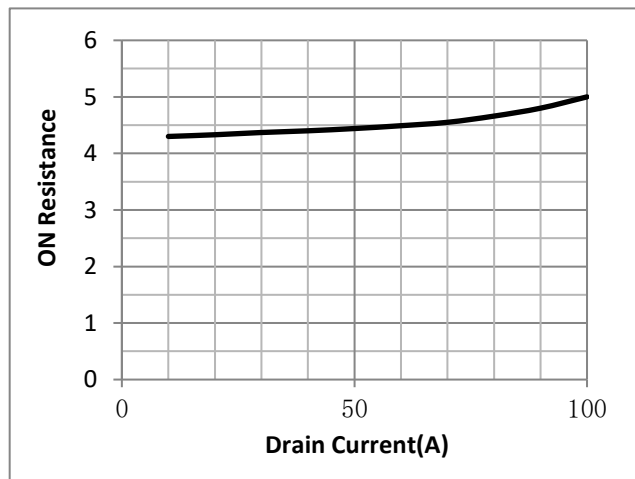

Fig.5 On-Resistance VS Gate Source Voltage

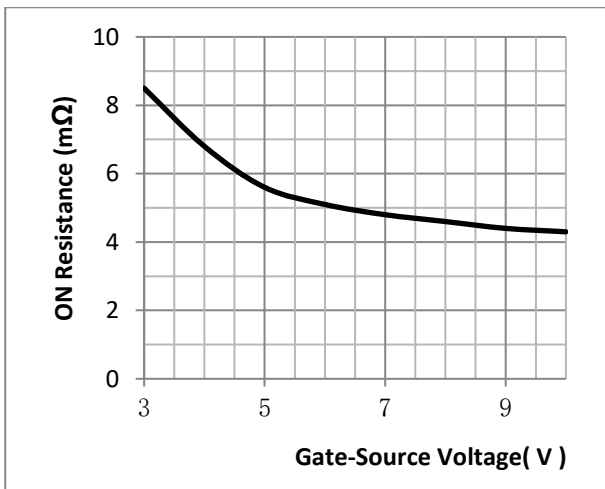

Fig.6 On-Resistance V.S Junction Temperature

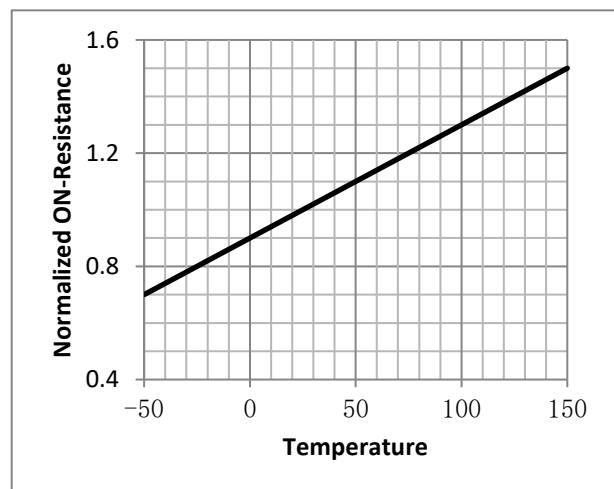

Fig.7 ID V.S Junction Temperature

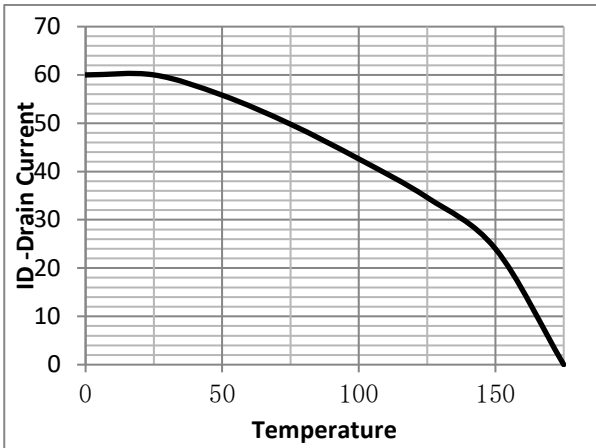

Fig.8 Switching Time Measurement Circuit

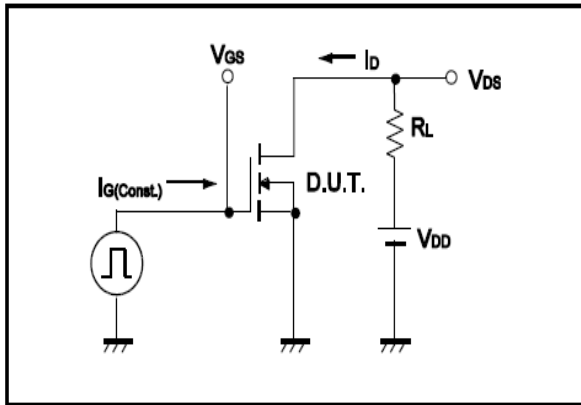

Fig.9 Gate Charge Waveform

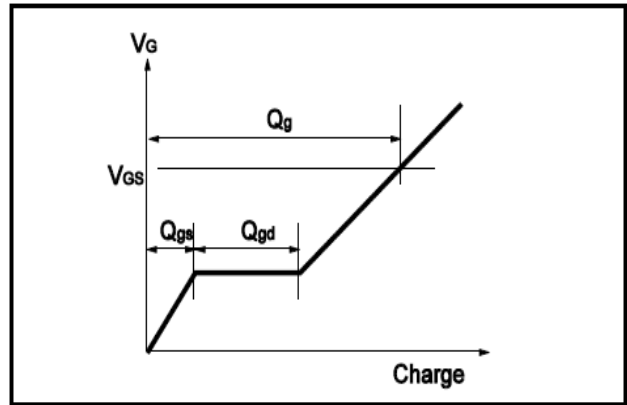

Fig.10 Switching Time Measurement Circuit

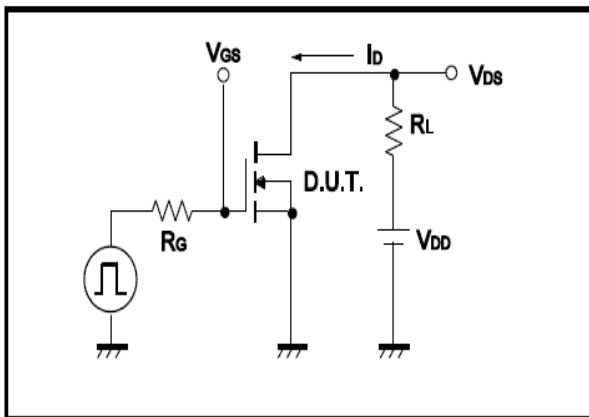

Fig.11 Gate Charge Waveform

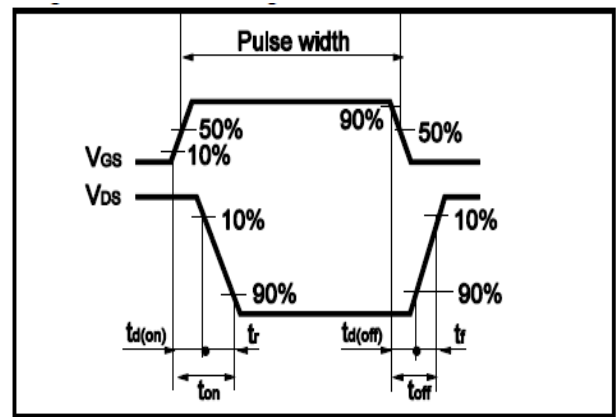

Fig.12 Avalanche Measurement Circuit

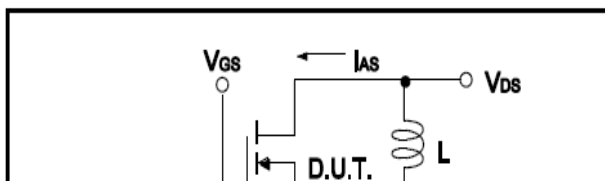
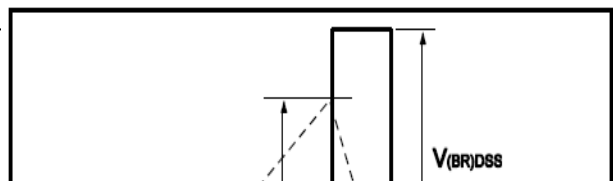

Fig.13 Avalanche Waveform





•Dimensions(DFN3×3)



Unit: mm

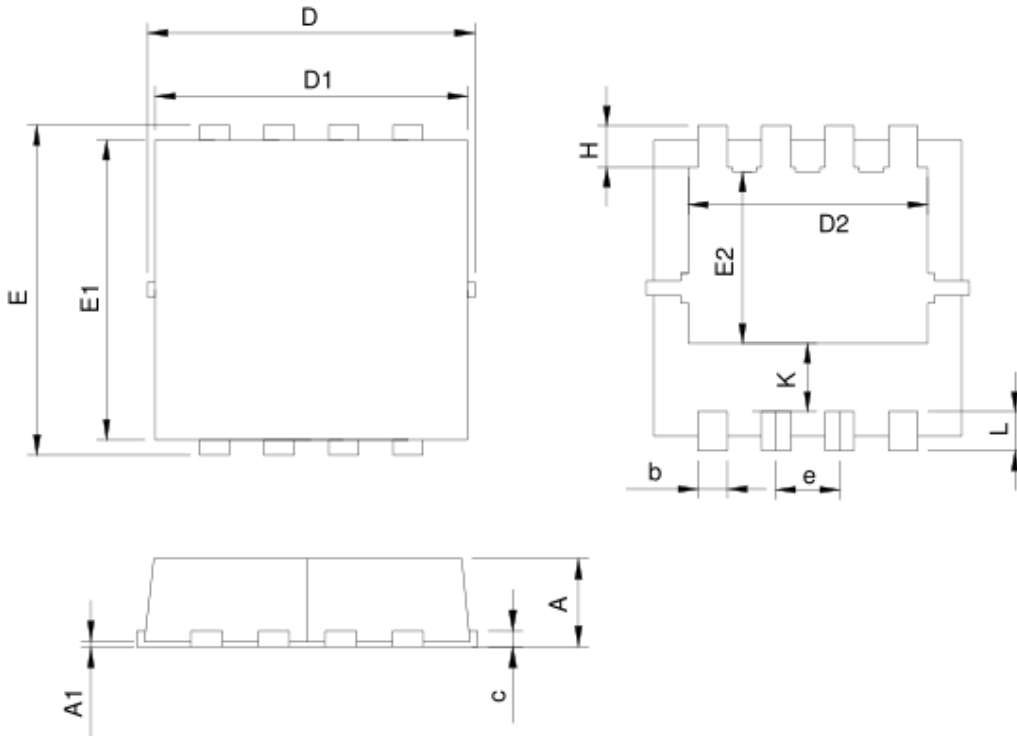

SYMBOL	DFN3.3x3.3-8			
	MILLIMETERS		INCHES	
	MIN.	MAX.	MIN.	MAX.
A	0.70	1.00	0.028	0.039
A1	0.00	0.05	0.000	0.002
b	0.25	0.35	0.010	0.014
c	0.14	0.20	0.006	0.008
D	3.10	3.50	0.122	0.138
D1	3.05	3.25	0.120	0.128
D2	2.35	2.55	0.093	0.100
E	3.10	3.50	0.122	0.138
E1	2.90	3.10	0.114	0.122
E2	1.64	1.84	0.065	0.072
e	0.65 BSC		0.026 BSC	
H	0.32	0.52	0.013	0.020
K	0.59	0.79	0.023	0.031
L	0.25	0.55	0.010	0.022

**RECOMMENDED LAND PATTERN**

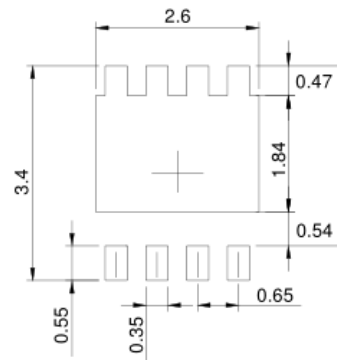

UNIT: mm