

**• General Description**

It combines advanced trench MOSFET technology with a low resistance package to provide extremely low  $R_{DS(ON)}$ . This device is ideal for load switch and battery protection applications.

**• Features**

- Advance high cell density Trench technology
- Low  $R_{DS(ON)}$  to minimize conductive loss
- Low Gate Charge for fast switching
- Low Thermal resistance

**• Application**

- MB/VGA Vcore
- SMPS 2<sup>nd</sup> Synchronous Rectifier
- POL application
- BLDC Motor driver

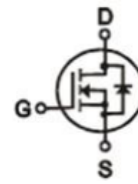
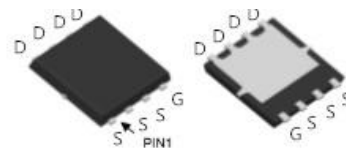
**• Product Summary**

 $V_{DS} = 40V$ 
 $R_{DS(ON)} = 1.7m\Omega$ 
 $I_D = 140A$ 

**DFN5 x 6**
**• Ordering Information:**

Part NO.	ZMS018N04NC
Marking	ZMS018N04
Packing Information	REEL TAPE
Basic ordering unit (pcs)	3000

**• Absolute Maximum Ratings (T<sub>C</sub>=25°C)**

Parameter	Symbol	Rating	Unit
Drain-Source Voltage	$V_{DS}$	40	V
Gate-Source Voltage	$V_{GS}$	±20	V
Continuous Drain Current	$I_D @ T_C=25^\circ C$	140	A
	$I_D @ T_C=75^\circ C$	106	A
	$I_D @ T_C=100^\circ C$	88	A
Pulsed Drain Current ①	$I_{DM}$	420	A
Total Power Dissipation	$P_D @ T_C=25^\circ C$	80	W
Total Power Dissipation	$P_D @ T_A=25^\circ C$	3.2	W
Operating Junction Temperature	$T_J$	-55 to 150	°C
Storage Temperature	$T_{STG}$	-55 to 150	°C
Single Pulse Avalanche Energy	$E_{AS}$	320	mJ



### •Thermal resistance

Parameter	Symbol	Min.	Typ.	Max.	Unit
Thermal resistance, junction - case	$R_{thJC}$	-	-	1.5	$^{\circ}C/W$
Thermal resistance, junction - ambient	$R_{thJA}$	-	-	40	$^{\circ}C/W$
Soldering temperature, wave soldering for 10s	$T_{sold}$	-	-	265	$^{\circ}C$

### •Electronic Characteristics

Parameter	Symbol	Condition	Min.	Typ	Max.	Unit
Drain-Source Breakdown Voltage	$BV_{DSS}$	$V_{GS} = 0V, I_D = 250\mu A$	40			V
Gate Threshold Voltage	$V_{GS(TH)}$	$V_{GS} = V_{DS}, I_D = 250\mu A$	1.2		2.5	V
Drain-Source Leakage Current	$I_{DSS}$	$V_{DS} = 40V, V_{GS} = 0V$			1.0	$\mu A$
Gate- Source Leakage Current	$I_{GSS}$	$V_{GS} = \pm 20V, V_{DS} = 0V$			$\pm 100$	nA
Static Drain-source On Resistance	$R_{DS(ON)}$	$V_{GS} = 10V, I_D = 24A$		1.7	2.0	m $\Omega$
		$V_{GS} = 4.5V, I_D = 12A$		2.9	3.6	m $\Omega$
Forward Transconductance	$g_{FS}$	$V_{DS} = 25V, I_D = 10A$		32		s
Source-drain voltage	$V_{SD}$	$I_S = 24A$			1.28	V

### •Electronic Characteristics

Parameter	Symbol	Condition	Min.	Typ	Max.	Unit
Input capacitance	$C_{iss}$	$f = 1MHz$ $V_{DS} = 25V$	-	2240	-	pF
Output capacitance	$C_{oss}$		-	620	-	
Reverse transfer capacitance	$C_{rss}$		-	46	-	

### •Gate Charge characteristics( $T_a = 25^{\circ}C$ )

Parameter	Symbol	Condition	Min.	Typ	Max.	Unit
Gate Resistance	$R_g$	$f = 1MHz$		2.3		$\Omega$
Total gate charge	$Q_g$	$V_{DD} = 25V$ $I_D = 8A$ $V_{GS} = 10V$	-	41	-	nC
Gate - Source charge	$Q_{gs}$		-	6.5	-	
Gate - Drain charge	$Q_{gd}$		-	11.8	-	
Turn-ON Delay time	$t_{D(on)}$	$V_{GS} = 10V, V_{DS} = 15V$ $R_G = 3.3\Omega,$		11		ns
Turn-ON Rise time	$t_r$			27		ns



Turn-Off Delay time	$t_{D(off)}$	$I_D = 20A$		24		ns
Turn-Off Fall time	$t_f$			12		ns
Reverse Recovery Time	$t_{RR}$	$V_{DD} = 20 V,$ $dI_S/dt = 100 A/s,$ $I_S = 30 A$		23		ns
Charge Time	$t_a$			11		ns
Discharge Time	$t_b$			8		ns
Reverse Recovery Charge	$Q_{RR}$			24		ns

Note: ① Pulse Test : Pulse width  $\leq 300\mu s$ , Duty cycle  $\leq 2\%$  ;

Fig.1 Power Dissipation

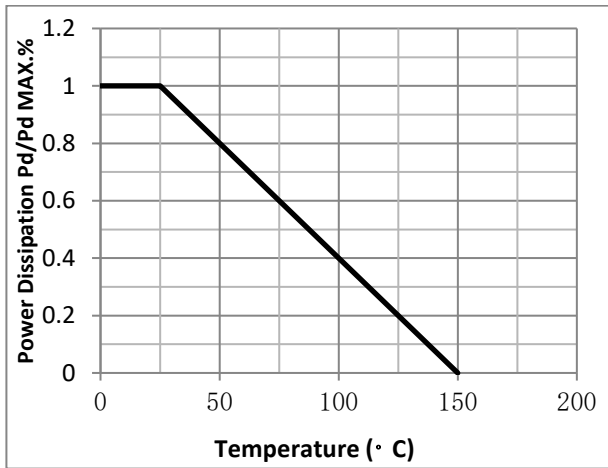

Fig.2 Typical output Characteristics

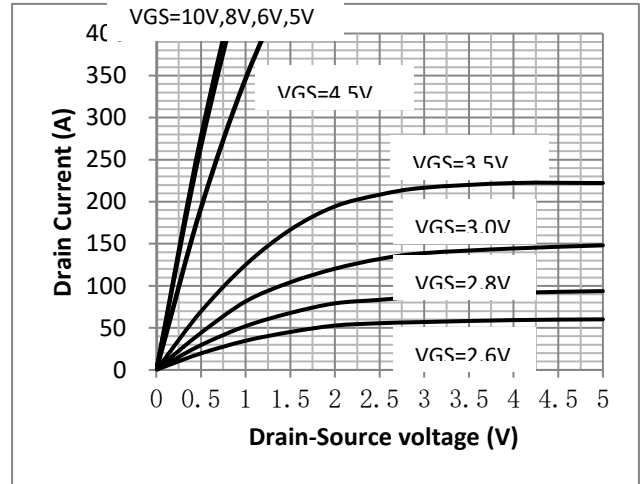

Fig.3 Threshold Voltage V.S Junction Temperature

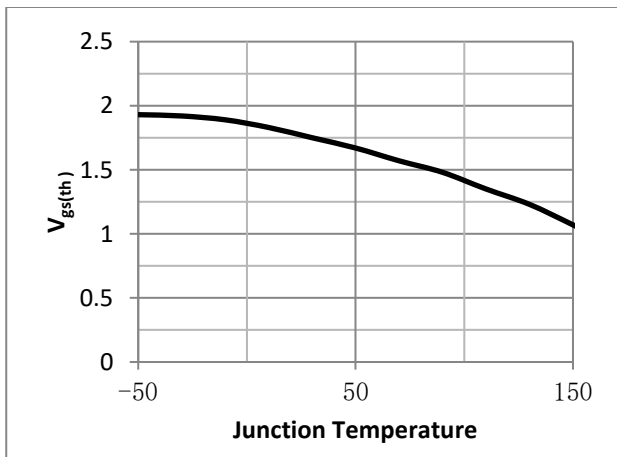

Fig.4 Resistance V.S Drain Current

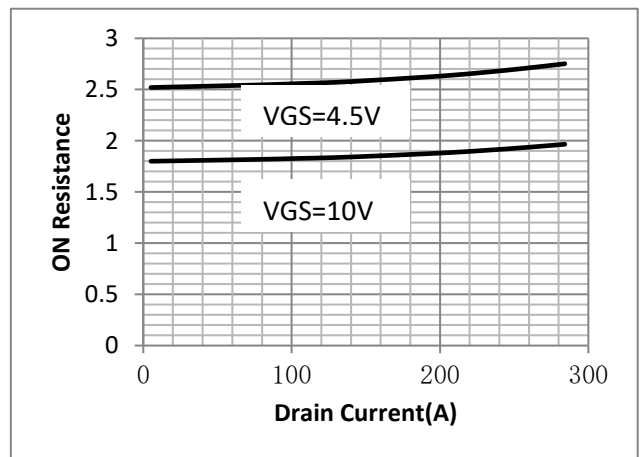



Fig.5 On-Resistance VS Gate Source Voltage

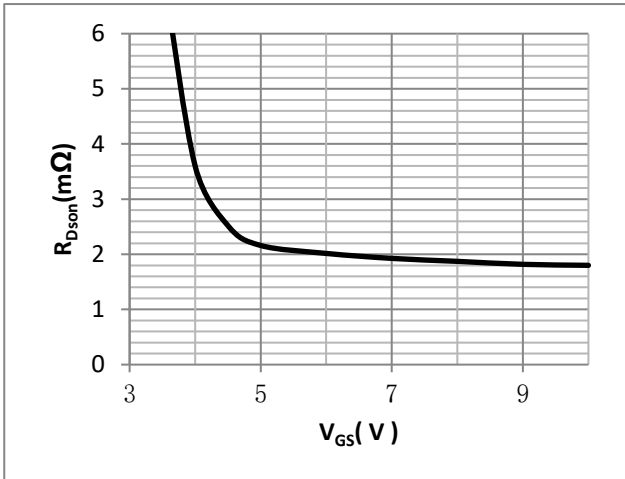

Fig.6 On-Resistance V.S Junction Temperature

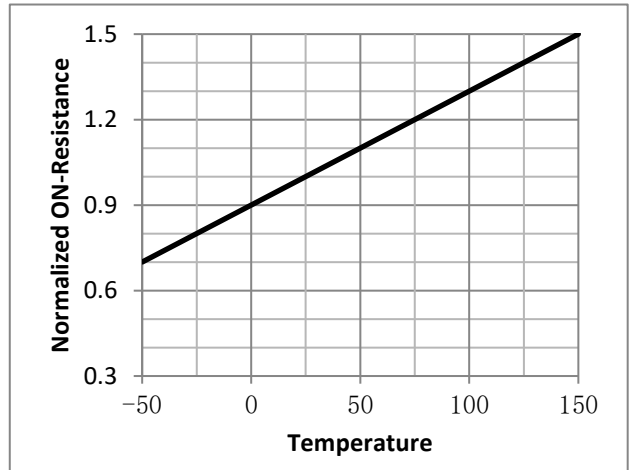

Fig.7 Gate Charge Characteristics

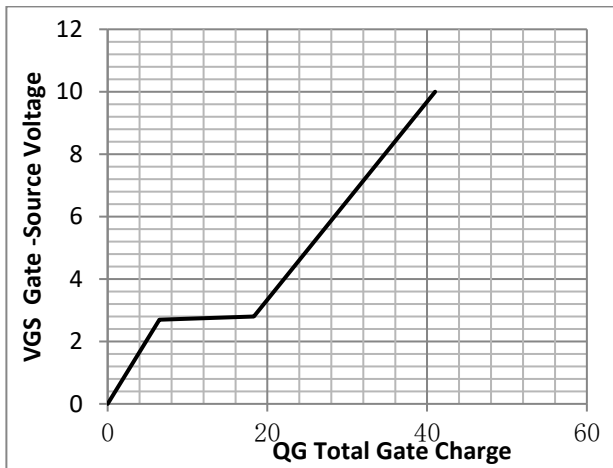

Fig.8 Capacitance vs Vds

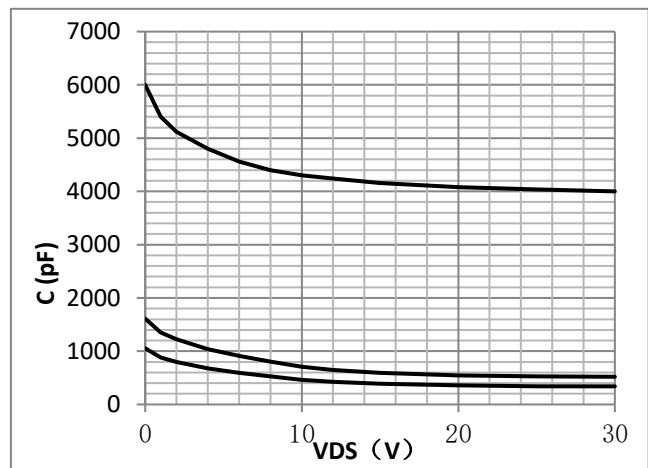

Figure 9. Diode Forward Voltage vs. Current

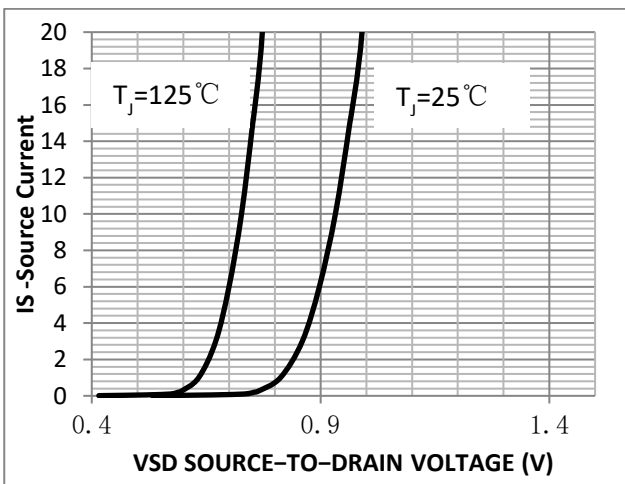

Figure 10. Transfer Characteristics

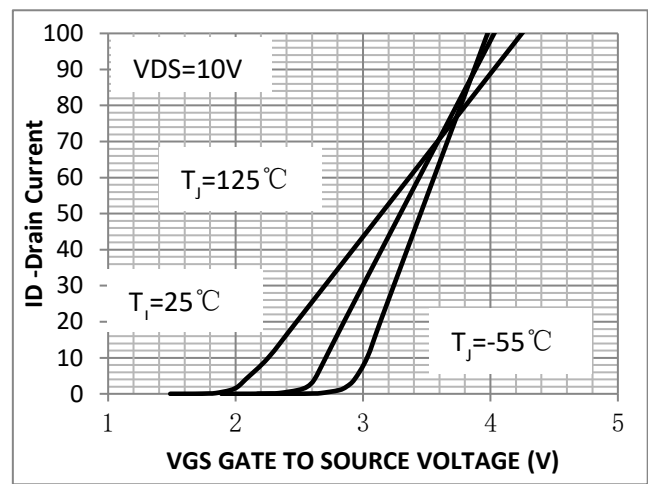

Fig.9 SOA Maximum Safe Operating Area

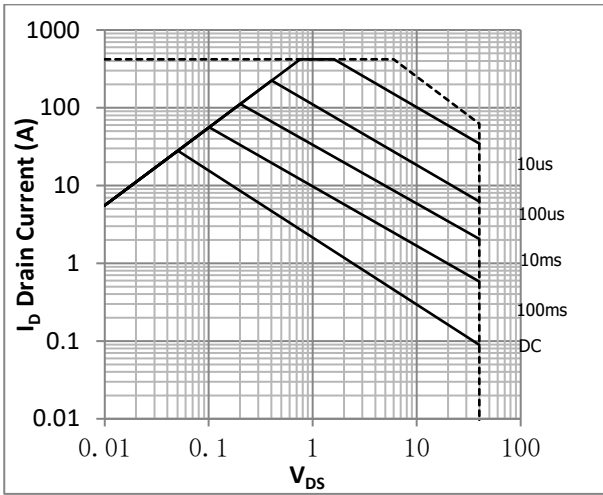

Fig.10  $I_D$ -Junction Temperature

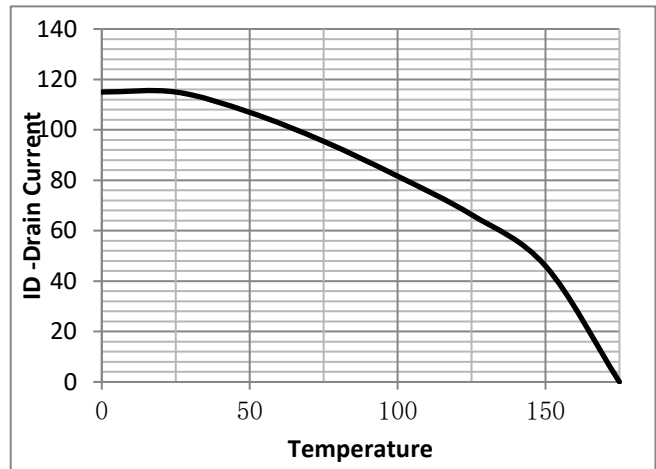

Fig.11 Switching Time Measurement Circuit

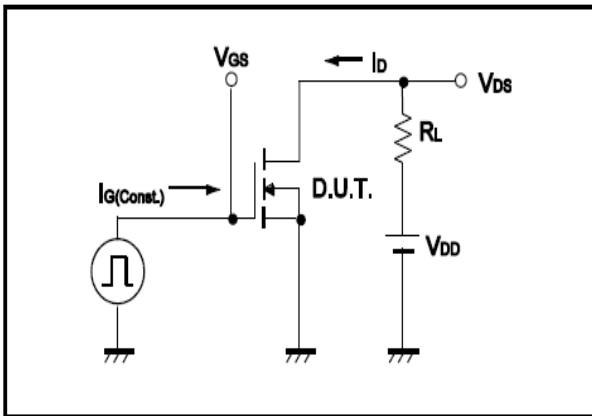

Fig.12 Gate Charge Waveform

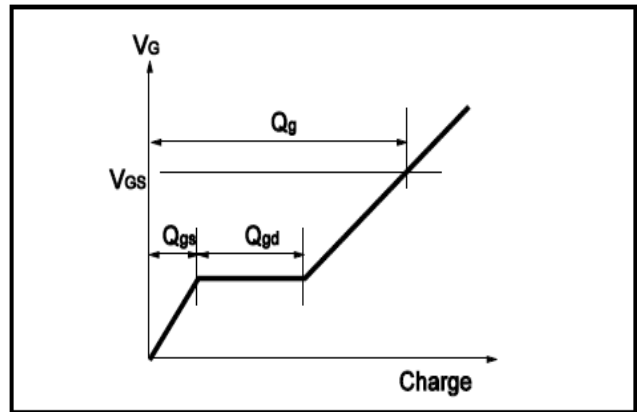

Fig.13 Resistive Switching Test Circuit

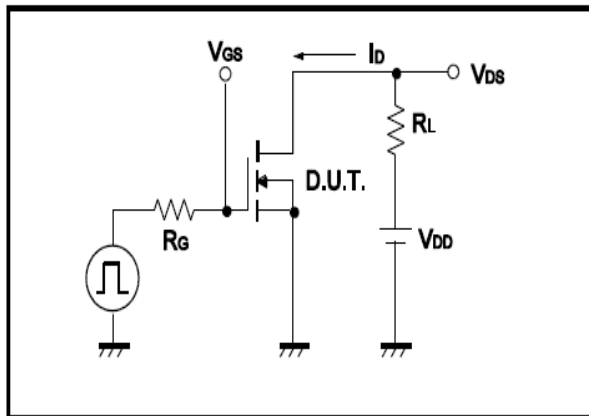

Fig.14 Resistive Switching Test Waveform

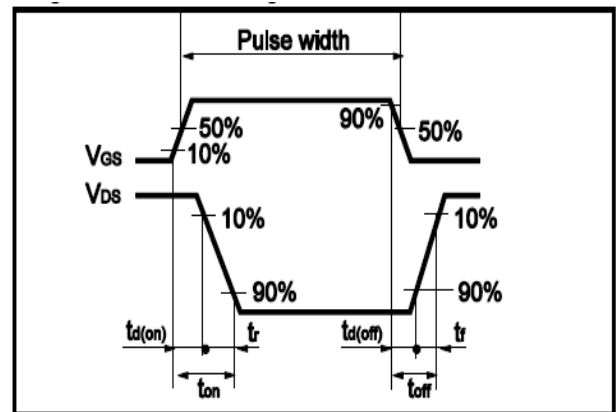



Fig.15 Avalanche Measurement Circuit

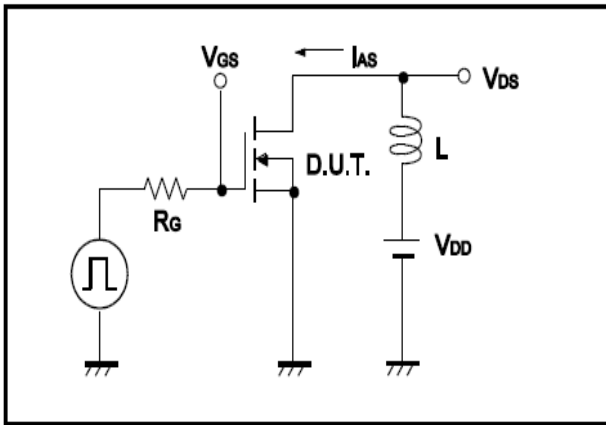
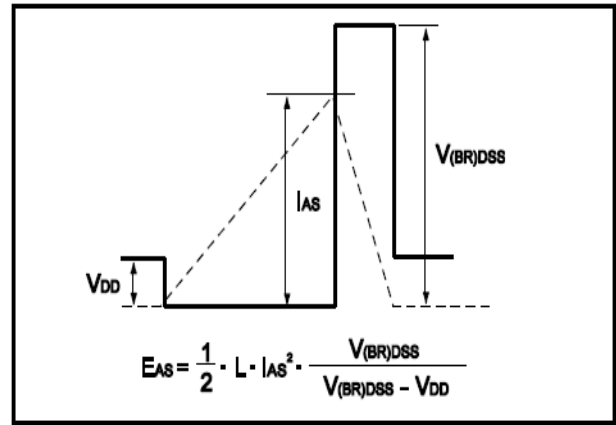

Fig.16 Avalanche Waveform





•Dimensions (DFN5x6)

Unit: mm

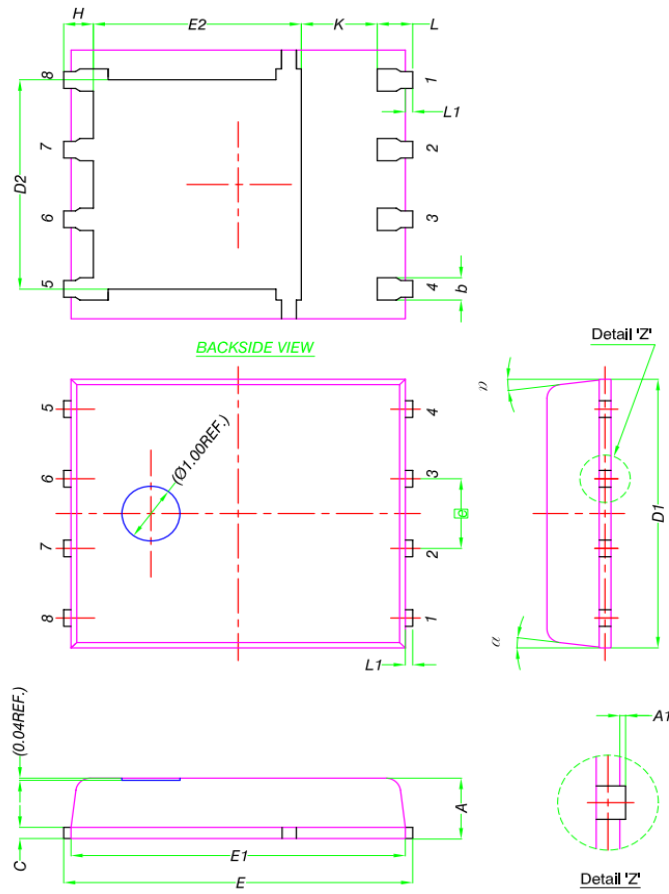

DIM.	MILLIMETERS		
	MIN.	NOM.	MAX.
A	0.90	1.00	1.10
A1	0	-	0.05
b	0.33	0.41	0.51
C	0.20	0.25	0.30
D1	4.80	4.90	5.00
D2	3.61	3.81	3.96
E	5.90	6.00	6.10
E1	5.70	5.75	5.80
E2	3.38	3.58	3.78
e	1.27 BSC		
H	0.41	0.51	0.61
K	1.10	-	-
L	0.51	0.61	0.71
L1	0.06	0.13	0.20
$\alpha$	0°	-	12°