

**• General Description**

The ZM027N03M combines advanced trench MOSFET technology with a low resistance package to provide extremely low $R_{DS(ON)}$. This device is ideal for switch and battery protection applications.

• Features

- Advance high cell density Trench technology
- Low $R_{DS(ON)}$ to minimize conductive loss
- Low Gate Charge for fast switching
- Low Thermal resistance

• Application

- MB/VGA Vcore
- SMPS 2nd Synchronous Rectifier
- POL application
- BLDC Motor driver

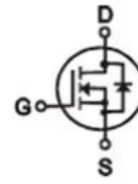
• Product Summary

$V_{DS} = 30V$

$R_{DS(ON)} = 2.9m\Omega$

$I_D = 65A$

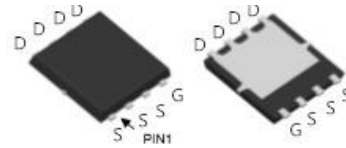

DFN3 x 3

• Ordering Information:

Part NO.	ZM027N03M
Marking	027N03
Packing Information	REEL TAPE
Basic ordering unit (pcs)	5000

• Absolute Maximum Ratings ($T_C = 25^\circ C$)

Parameter	Symbol	Rating	Unit
Drain-Source Voltage	V_{DS}	30	V
Gate-Source Voltage	V_{GS}	± 20	V
Continuous Drain Current	$I_D @ T_C = 25^\circ C$	65	A
	$I_D @ T_C = 75^\circ C$	49	A
	$I_D @ T_C = 100^\circ C$	40	A
	$I_D @ T_A = 25^\circ C$	21	A
	$I_D @ T_A = 70^\circ C$	17	A
Pulsed Drain Current ^①	I_{DM}	195	A
Total Power Dissipation	$P_D @ T_C = 25^\circ C$	46	W
Total Power Dissipation	$P_D @ T_A = 25^\circ C$	2.3	W
Operating Junction Temperature	T_J	-55 to 150	$^\circ C$
Storage Temperature	T_{STG}	-55 to 150	$^\circ C$



Single Pulse Avalanche Energy (L=0.5mH, VGS=10V, Rg=25Ω, TJ=25°C)	E_{AS}	350	mJ
Single Pulse Avalanche Energy (L=0.1mH, VGS=10V, Rg=25Ω, TJ=25°C)	E_{AS}	180	mJ

•Thermal resistance

Parameter	Symbol	Min.	Typ.	Max.	Unit
Thermal resistance, junction - case	R_{thJC}	-	-	2.7	° C/W
Thermal resistance, junction - ambient	R_{thJA}	-	-	53	° C/W
Soldering temperature, wave soldering for 10s	T_{sold}	-	-	265	° C

•Electronic Characteristics

Parameter	Symbol	Condition	Min.	Typ	Max.	Unit
Drain-Source Breakdown Voltage	BV_{DSS}	$V_{GS} = 0V, I_D = 250\mu A$	30			V
Gate Threshold Voltage	$V_{GS(TH)}$	$V_{GS} = V_{DS}, I_D = 250\mu A$	1.2		2.5	V
Drain-Source Leakage Current	I_{DSS}	$V_{DS} = 30V, V_{GS} = 0V$			1.0	μA
Gate- Source Leakage Current	I_{GSS}	$V_{GS} = \pm 20V, V_{DS} = 0V$			± 100	nA
Static Drain-source On Resistance	$R_{DS(ON)}$	$V_{GS} = 10V, I_D = 24A$		2.9	3.8	mΩ
		$V_{GS} = 4.5V, I_D = 12A$		4.6	5.5	mΩ
Forward Transconductance	g_{FS}	$V_{DS} = 25V, I_D = 10A$		30		s
Source-drain voltage	V_{SD}	$I_S = 24A$			1.28	V

•Dynamic Characteristics

Parameter	Symbol	Condition	Min.	Typ	Max.	Unit
Input capacitance	C_{iss}	$f = 1MHz,$ $V_{DS} = 25V$	-	2800	-	pF
Output capacitance	C_{oss}		-	420	-	
Reverse transfer capacitance	C_{rss}		-	280	-	
Gate Resistance	R_g	$f = 1MHz$		2.5		Ω
Total gate charge	Q_g	$V_{DD} = 25V$ $I_D = 8A$ $V_{GS} = 10V$	-	27	-	nC
Gate - Source charge	Q_{gs}		-	8.6	-	
Gate - Drain charge	Q_{gd}		-	13.8	-	
Turn-ON Delay time	$t_{D(on)}$			12		ns



Turn-ON Rise time	t_r	$V_{GS}=10V, V_{DS}=15V$	44	ns
Turn-Off Delay time	$t_{D(off)}$		50	ns
Turn-Off Fall time	t_f		15	ns
Reverse Recovery Time	t_{RR}	$V_{DD} = 20V,$ $dI_S/dt = 100A/s,$ $I_S = 30A$	5.8	ns
Charge Time	t_a		3.4	ns
Discharge Time	t_b		2.4	ns
Reverse Recovery Charge	Q_{RR}		1.6	nC

Note: ① Pulse Test : Pulse width $\leq 300\mu s$, Duty cycle $\leq 2\%$;

Fig.1 Power Dissipation

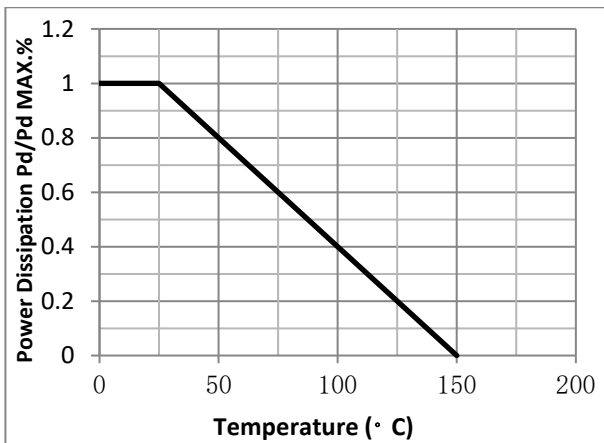

Fig.2 Typical output Characteristics

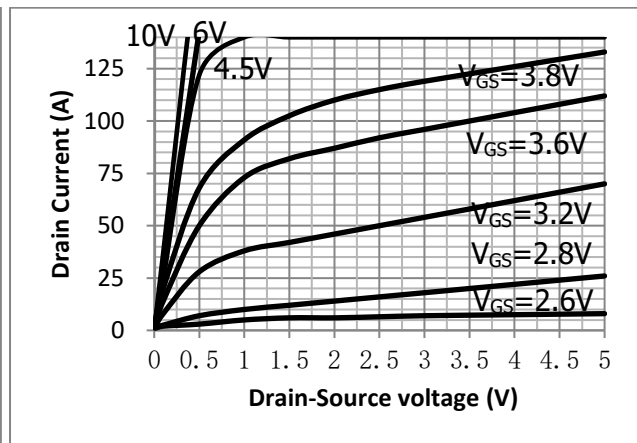

Fig.3 Threshold Voltage V.S Junction Temperature

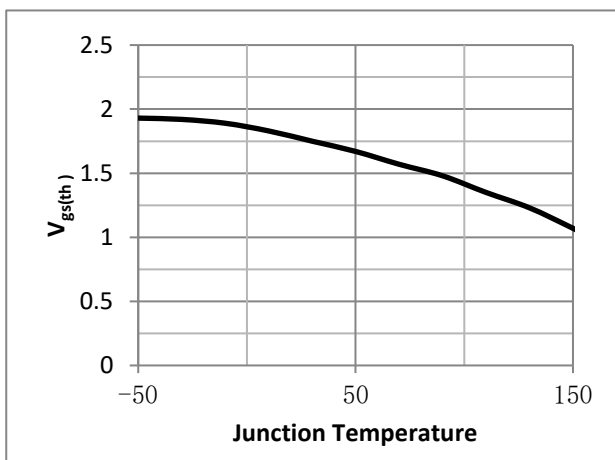

Fig.4 Resistance V.S Drain Current

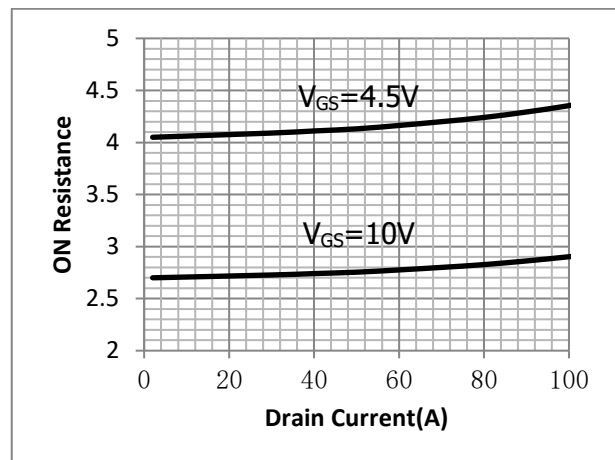



Fig.5 On-Resistance VS Gate Source Voltage

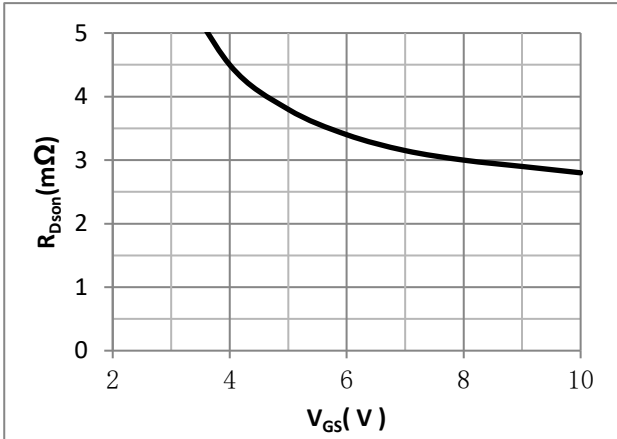

Fig.6 On-Resistance V.S Junction Temperature

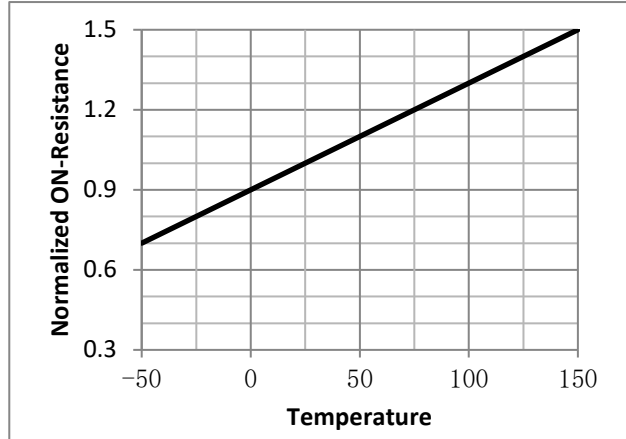

Fig.7 SOA Maximum Safe Operating Area

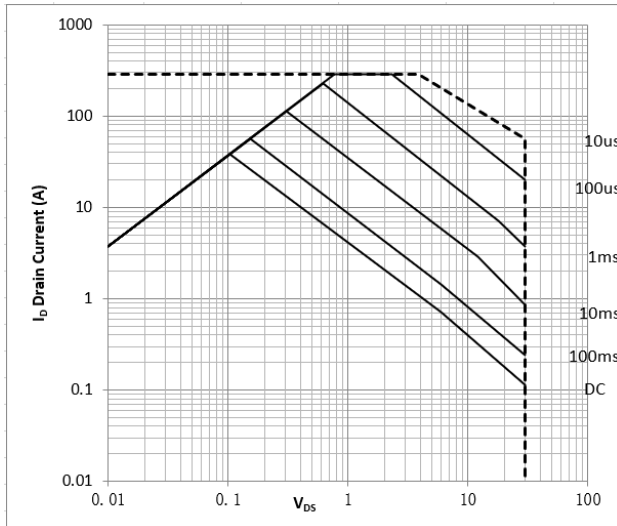

Fig.8 ID-Junction Temperature

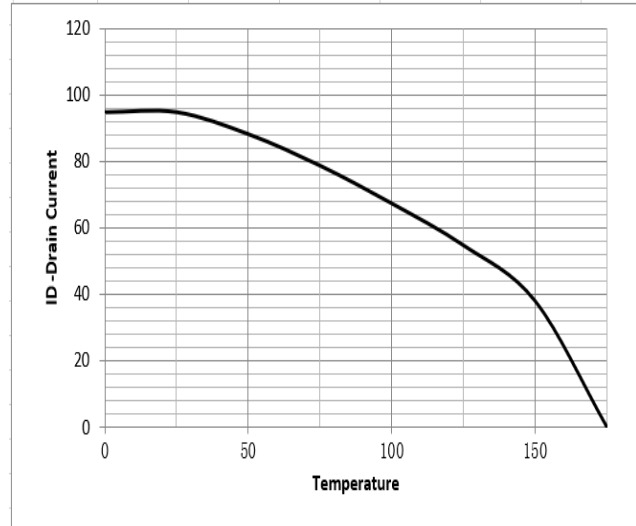

Figure 9. Diode Forward Voltage vs. Current

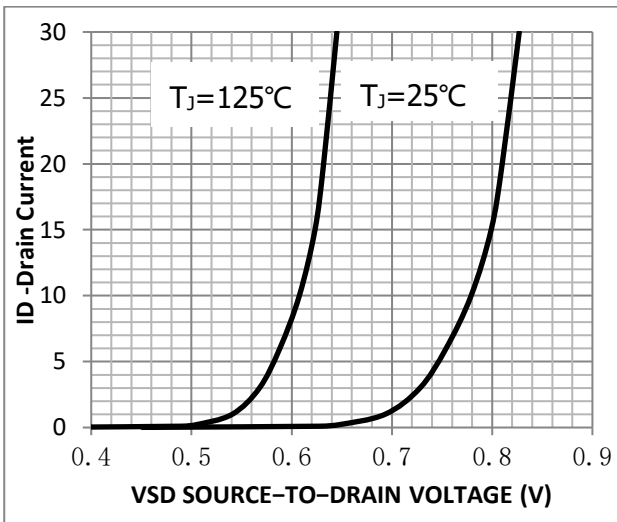

Figure 10. Transfer Characteristics

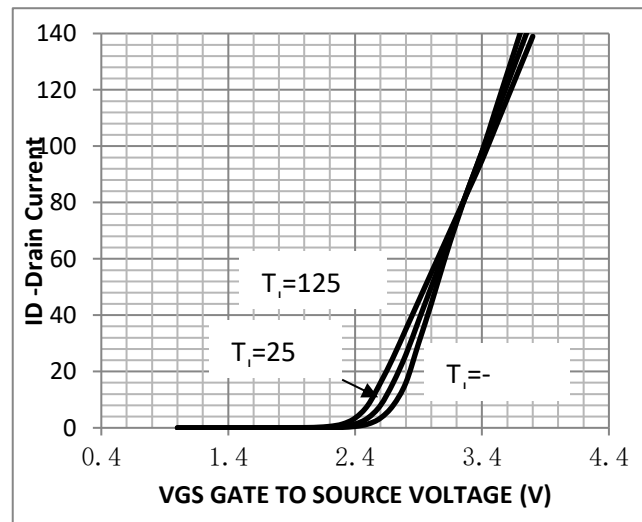

Figure 11. Gate-to-Source and Drain-to-Source Voltage vs. Total Charge

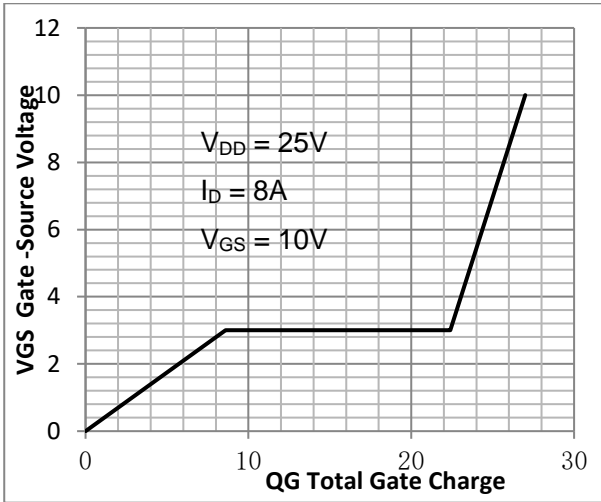

Fig.12 Capacitance Variation

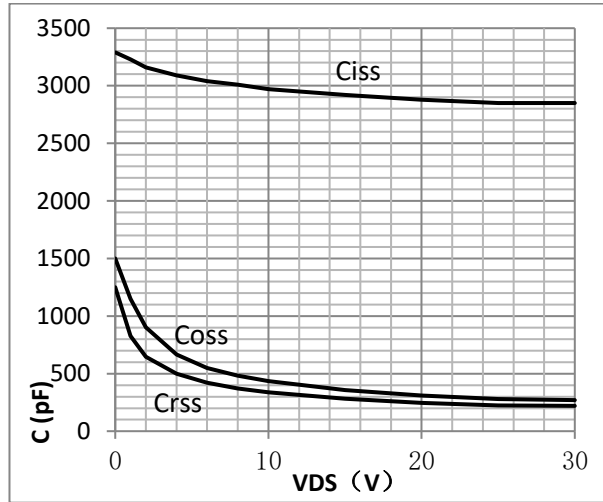

Fig.13 Switching Time Measurement Circuit

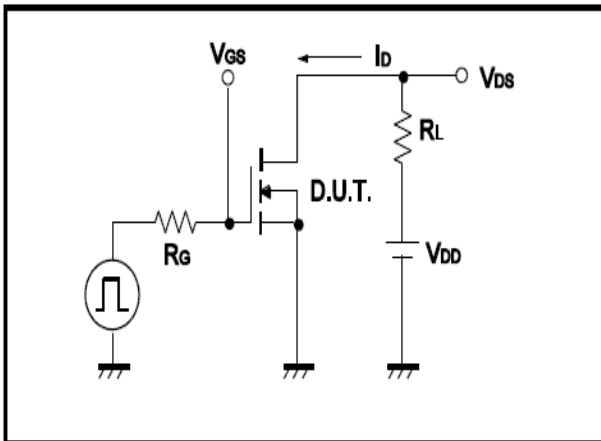

Fig.14 Gate Charge Waveform

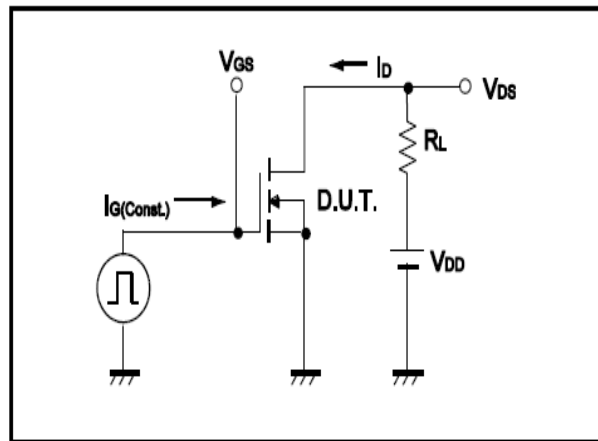

Fig.15 Avalanche Measurement Circuit

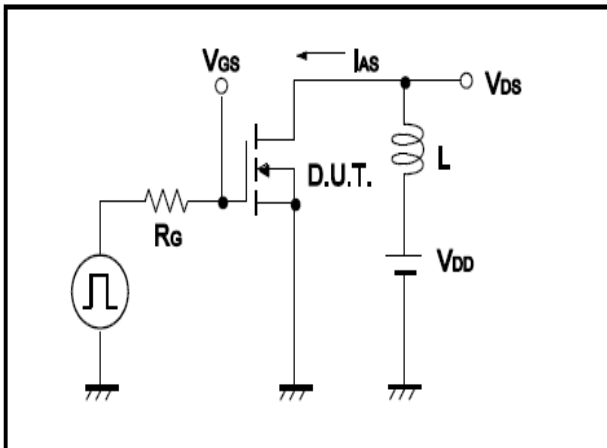

Fig.16 Avalanche Waveform

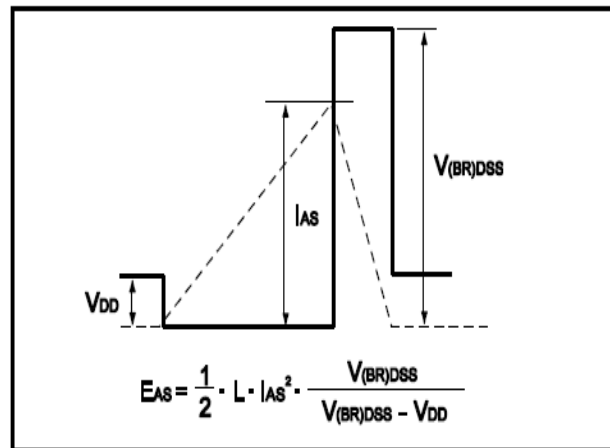
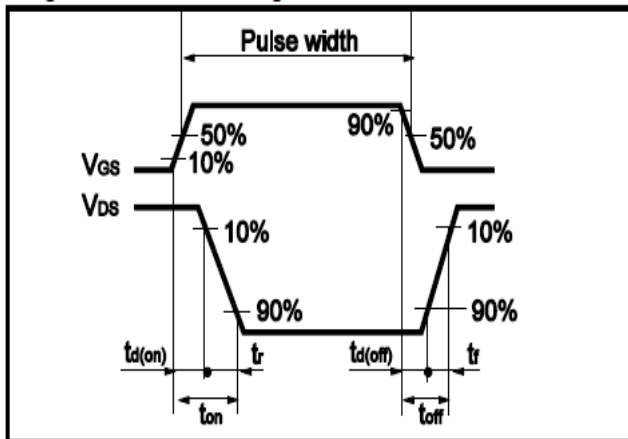



Fig.17 Gate Charge Waveform





•Dimensions(DFN3x3)

Unit: mm

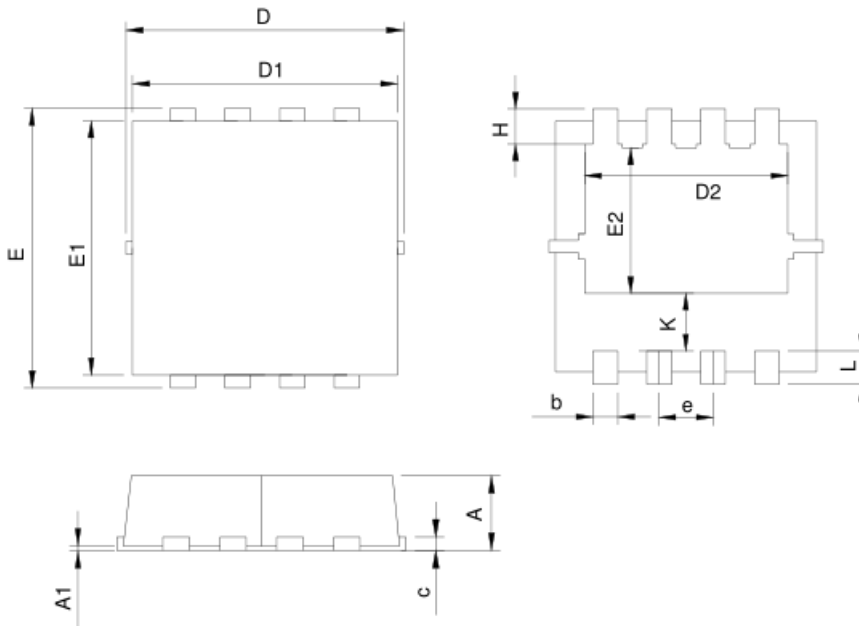

L O B M S	DFN3.3x3.3-8			
	MILLIMETERS		INCHES	
	MIN.	MAX.	MIN.	MAX.
A	0.70	1.00	0.028	0.039
A1	0.00	0.05	0.000	0.002
b	0.25	0.35	0.010	0.014
c	0.14	0.20	0.006	0.008
D	3.10	3.50	0.122	0.138
D1	3.05	3.25	0.120	0.128
D2	2.35	2.55	0.093	0.100
E	3.10	3.50	0.122	0.138
E1	2.90	3.10	0.114	0.122
E2	1.64	1.84	0.065	0.072
e	0.65 BSC		0.026 BSC	
H	0.32	0.52	0.013	0.020
K	0.59	0.79	0.023	0.031
L	0.25	0.55	0.010	0.022

RECOMMENDED LAND PATTERN

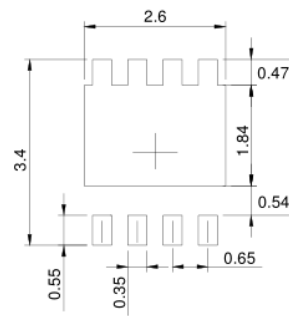

UNIT: mm