

• General Description

It combines advanced trench MOSFET technology with a low resistance package to provide extremely low $R_{DS(ON)}$.

• Features

- Advance device constructure
- Low $R_{DS(ON)}$ to minimize conduction loss
- Low Gate Charge for fast switching
- Low Thermal resistance

• Application

- Synchronous Rectification for AC-DC/DC-DC converter
- Oring switches
- Power Tools

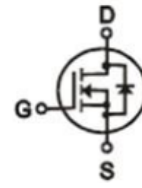
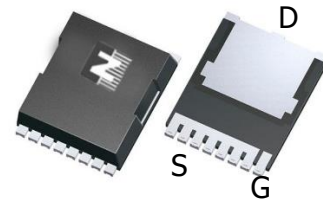
• Product Summary

 $V_{DS}=80V$
 $R_{DS(ON)} = 1.6m\Omega$
 $I_D=240A$

TOLL
• Ordering Information:

Part NO.	ZMS015N08HR
Marking	ZMS015N08
Packing Information	REEL TAPE
Basic ordering unit (pcs)	1000

• Absolute Maximum Ratings ($T_C = 25^\circ C$)

Parameter	Symbol	Rating	Unit
Drain-Source Voltage	V_{DS}	80	V
Gate-Source Voltage	V_{GS}	± 20	V
Continuous Drain Current	$I_D@T_C=25^\circ C$	240	A
	$I_D@T_C=75^\circ C$	182	A
	$I_D@T_C=100^\circ C$	151	A
Pulsed Drain Current ①	I_{DM}	720	A
Diode continuous forward current	I_S	175	A
Diode pulse current	$I_{S,pulse}$	525	A
Total Power Dissipation	$P_D@T_C=25^\circ C$	290	W
Operating Junction Temperature	T_J	-55 to 150	$^\circ C$
Storage Temperature	T_{STG}	-55 to 150	$^\circ C$
Single Pulse Avalanche Energy@L=0.1mH	E_{AS}	480	mJ

•Thermal resistance

Parameter	Symbol	Min.	Typ.	Max.	Unit
Thermal resistance, junction - case	R _{thJC}	-	-	0.43	° C/W
Thermal resistance, junction - ambient	R _{thJA}	-	-	40	° C/W
Soldering temperature, wavesoldering for 10s	T _{sold}	-	-	265	° C

•Electronic Characteristics

Parameter	Symbol	Condition	Min.	Typ	Max.	Unit
Drain-Source Breakdown Voltage	BV _{DSS}	V _{GS} =0V, I _D =250uA	80			V
Gate Threshold Voltage	V _{GS(TH)}	V _{GS} =V _{DS} , I _D =250uA	2		4	V
Drain-Source Leakage Current	I _{DSS}	V _{DS} =80V, V _{GS} =0V			1.0	uA
Gate- Source Leakage Current	I _{GSS}	V _{GS} =±20V, V _{DS} =0V			±100	nA
Static Drain-source On Resistance	R _{DS(ON)}	V _{GS} =10V, I _D =30A		1.6	2.1	mΩ
Forward Transconductance	g _{FS}	V _{DS} =10V, I _D =40A		28		s
Source-drain voltage	V _{SD}	I _S =100A			1.28	V

•Electronic Characteristics

Parameter	Symbol	Condition	Min.	Typ	Max.	Unit
Input capacitance	C _{iss}	f = 1MHz V _{DS} =25V	-	9130	-	pF
Output capacitance	C _{oss}		-	6640	-	
Reverse transfer capacitance	C _{rss}		-	117	-	

•Gate Charge characteristics(T_a = 25°C)

Parameter	Symbol	Condition	Min.	Typ	Max.	Unit
Gate Resistance	R _g	f = 1MHz		2.5		Ω
Total gate charge	Q _g	V _{DD} =30V I _D = 30A V _{GS} = 10V	-	121	-	nC
Gate - Source charge	Q _{gs}		-	24	-	
Gate - Drain charge	Q _{gd}		-	23	-	
Turn-On Time	t _{on}	V _{GS} =10V, V _{DS} =15V R _G =3.3Ω, I _D =25A		112		ns
Turn-ON Delay time	t _{D(on)}			41		
Turn-ON Rise time	t _r			65		ns
Turn-Off Delay time	t _{D(off)}			130		ns

Turn-Off Fall time	t_f	VDD = 20 V, dIS/dt = 100 A/s, IS = 30 A	34	ns
Reverse Recovery Time	t_{RR}		85	ns
Charge Time	t_a		34	ns
Discharge Time	t_b		28	ns
Reverse Recovery Charge	Q_{RR}		120	nC

Note: ① Pulse Test : Pulse width $\leq 10\mu s$, Duty cycle $\leq 1\%$;

Fig.1 Gate-Charge Characteristics

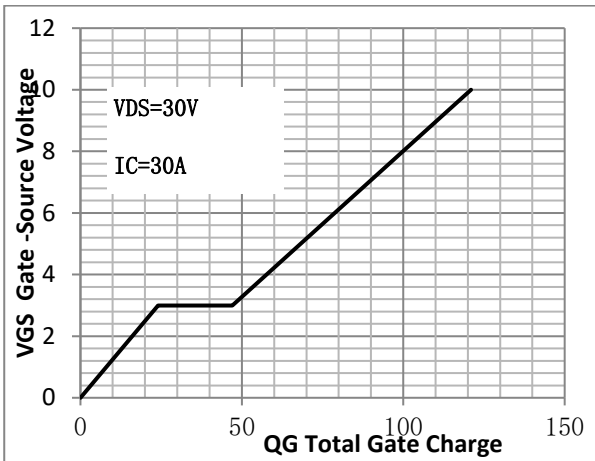

Fig.2 Capacitance Characteristics

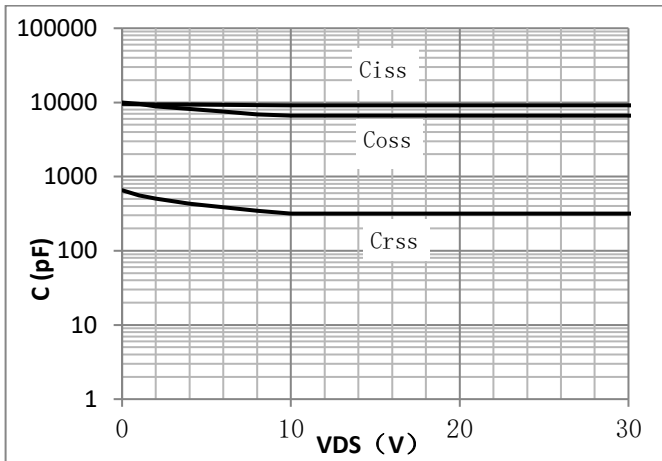

Fig.3 Power Dissipation

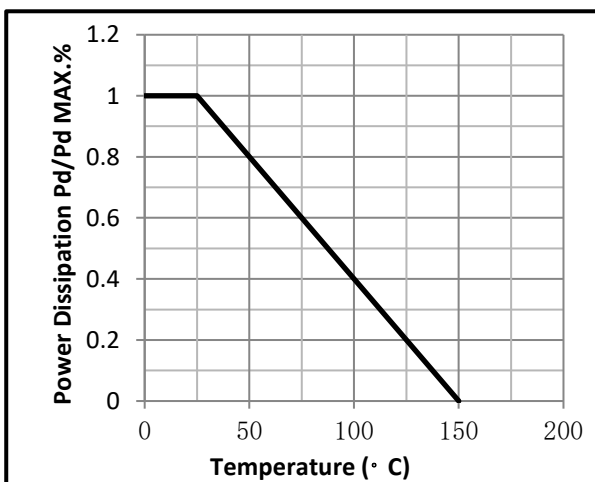

Fig.4 Typical output Characteristics

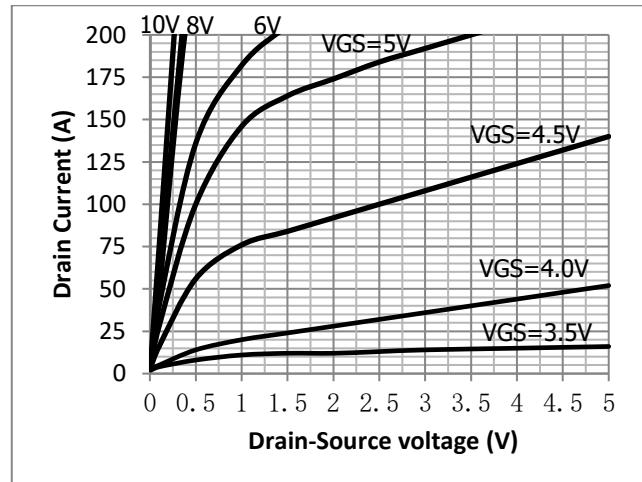

Fig.5 Threshold Voltage V.S Junction Temperature

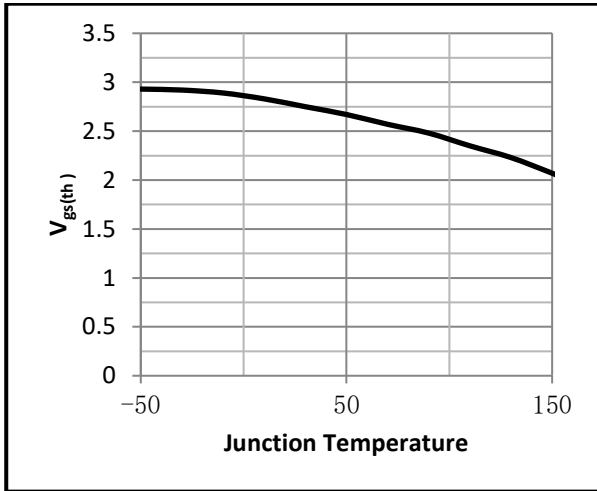

Fig.6 Resistance V.S Drain Current

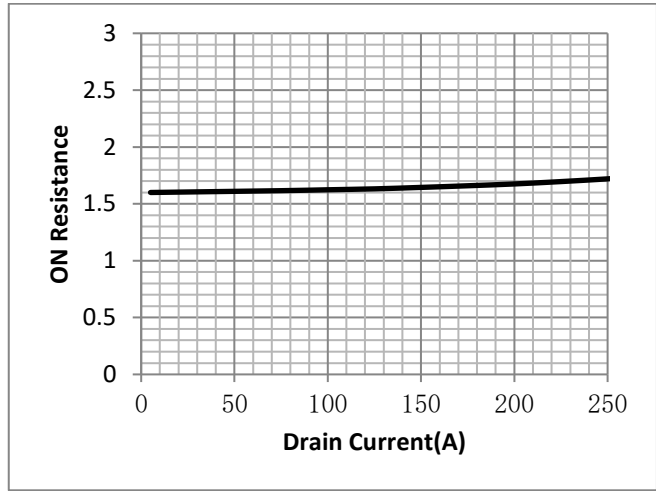

Fig.7 On-Resistance VS Gate Source Voltage

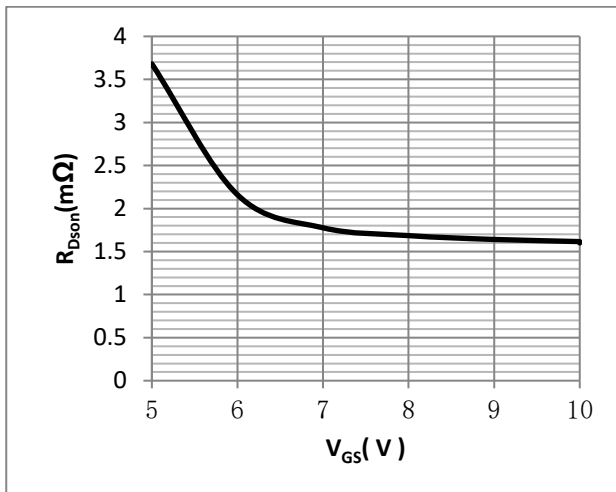

Fig.8 On-Resistance V.S Junction Temperature

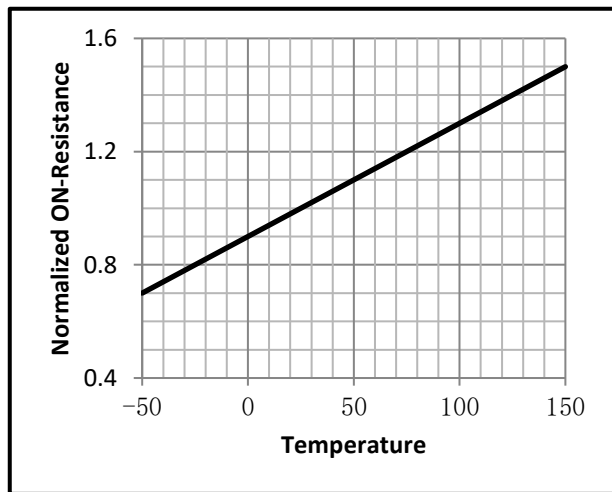

Fig.9 SOA Maximum Safe Operating Area

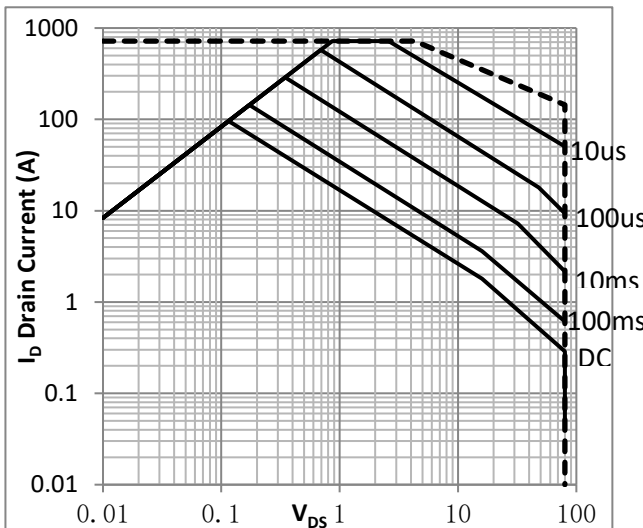

Fig.10 ID-Junction Temperature

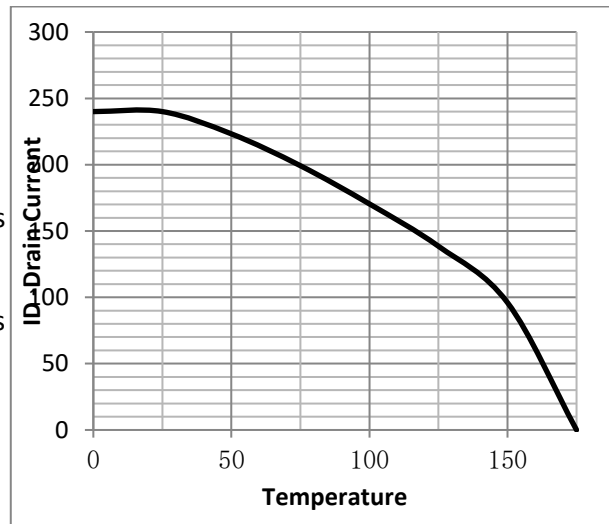

Figure.11 Diode Forward Voltage vs. Current

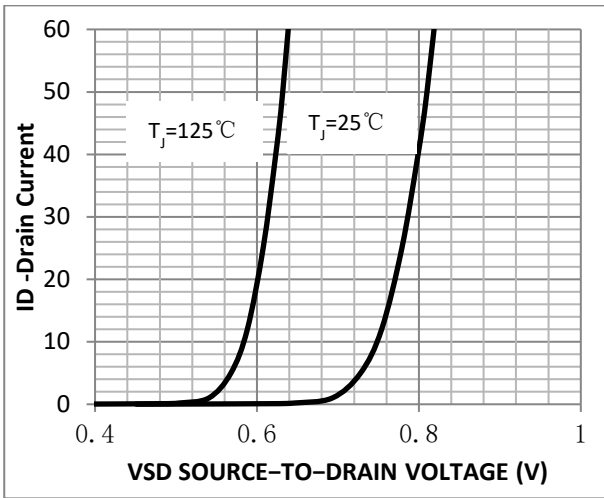

Figure.12 Transfer Characteristics

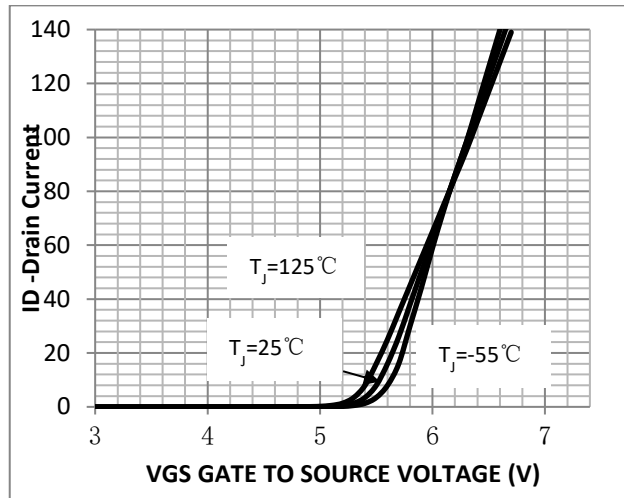

Fig.13 Switching Time Measurement Circuit

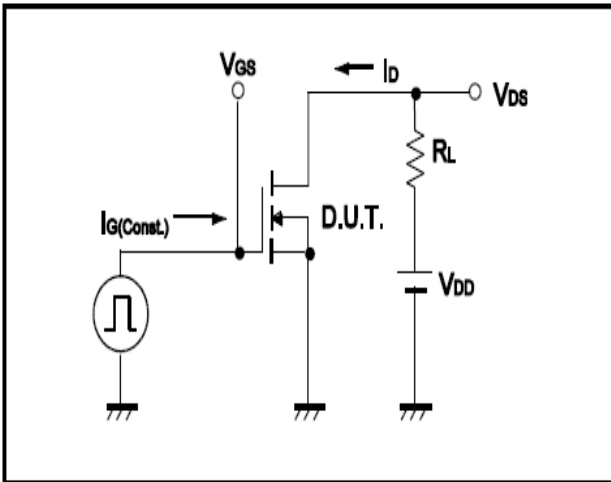

Fig.14 Gate Charge Waveform

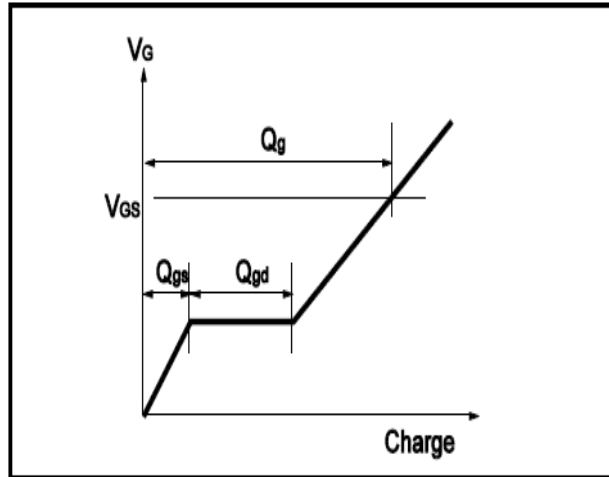

Fig.15 Switching Time Measurement Circuit

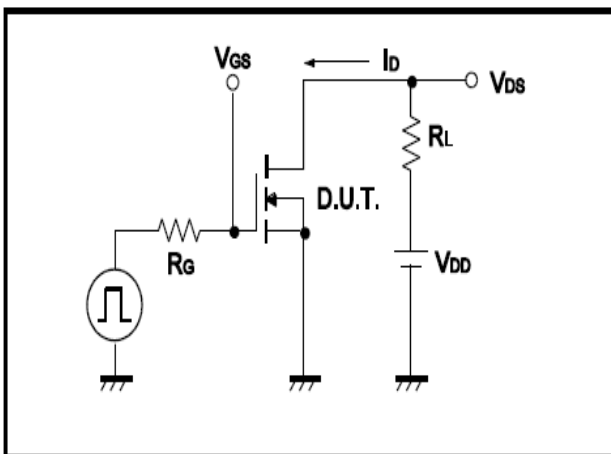
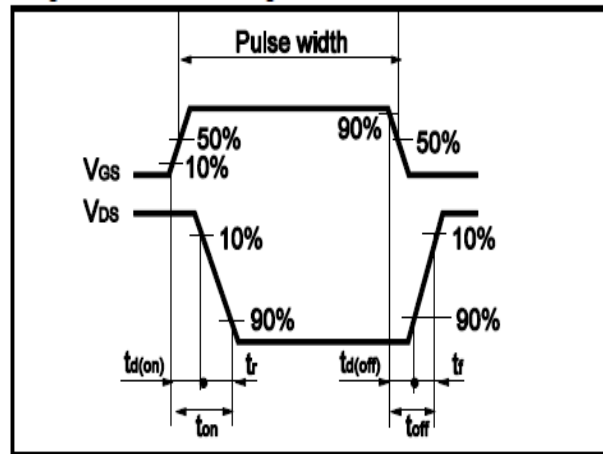
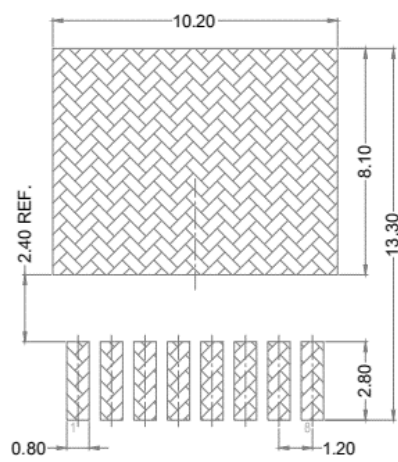
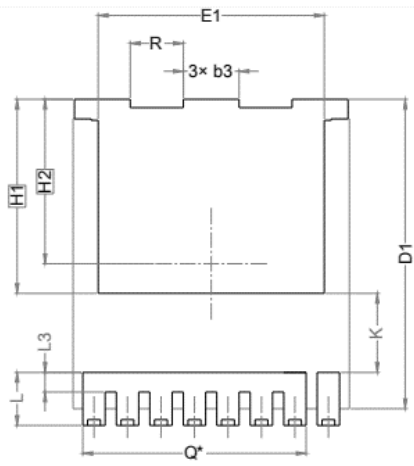
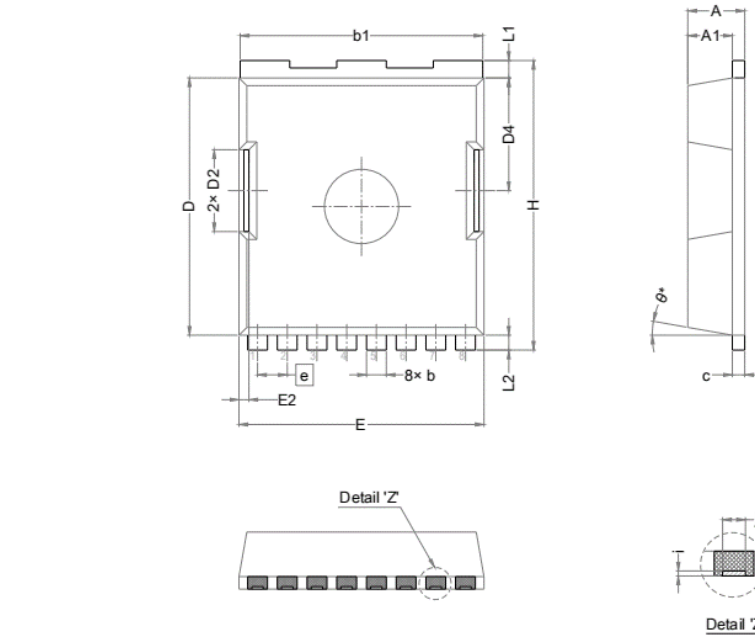

Fig.16 Gate Charge Waveform



•Dimensions (TOLL)

Unit: mm



SYMBOL	DIMENSIONS		
	MIN.	NOM.	MAX.
A	2.20	2.30	2.40
A1	1.70	1.80	1.90
b	0.70	0.80	0.90
b1	9.70	9.80	9.90
b3	1.90	2.00	2.10
c	0.40	0.50	0.60
D	10.28	10.38	10.48
D1	10.98	11.08	11.18
D2	3.20	3.30	3.40
D4	4.45	4.55	4.65
E	9.80	9.90	10.00
E1	8.00	8.10	8.20
E2	0.30	0.40	0.50
e	1.20 BSC		
H	11.58	11.68	11.78
H1	6.95 BSC		
H2	5.89 BSC		
i	0.10 REF.		
j	0.46 REF.		
K	2.80 REF.		
L	1.60	1.90	2.10
L1	0.60	0.70	0.80
L2	0.50	0.60	0.70
L3	0.60	0.70	0.80
N	8		
Q	6.80 REF.		
R	1.80	1.90	2.00
θ	10° REF.		