

### • General Description

It combines advanced trench MOSFET technology with a low resistance package to provide extremely low  $R_{DS(ON)}$ . It combines one N Channel MOSFET and one P channel MOSFET.

### • Features

- Advance high cell density Trench technology
- Low  $R_{DS(ON)}$  to minimize conductive loss
- Low Gate Charge for fast switching
- Dual DIE in one package

### • Application

- Power Management in Notebook Computer
- BLDC Motor driver

### • Ordering Information:

Part NO.	ZMC88602D
Marking	ZMC88602
Packing Information	REEL TAPE
Basic ordering unit (pcs)	2500

### • N Channel Absolute Maximum Ratings ( $T_C = 25^\circ\text{C}$ )

Parameter	Symbol	Rating	Unit
Drain-Source Voltage	$V_{DS}$	60	V
Gate-Source Voltage	$V_{GS}$	20	V
Continuous Drain Current	$I_D @ T_C = 25^\circ\text{C}$	21	A
	$I_D @ T_C = 75^\circ\text{C}$	16	A
	$I_D @ T_C = 100^\circ\text{C}$	13	A
Pulsed Drain Current <sup>①</sup>	$I_{DM}$	63	A
Total Power Dissipation	$P_D @ T_C = 25^\circ\text{C}$	50	W
Total Power Dissipation	$P_D @ T_A = 25^\circ\text{C}$	2.0	W
Operating Junction Temperature	$T_J$	-55 to 150	$^\circ\text{C}$
Storage Temperature	$T_{STG}$	-55 to 150	$^\circ\text{C}$
Single Pulse Avalanche Energy	$E_{AS}$	30	mJ

### • Product Summary

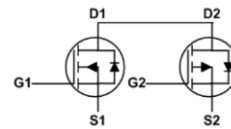

$V_{DS1} = 60\text{V}$   
 $V_{DS2} = -60\text{V}$   
 $R_{DS(ON)1} = 28\text{m}\Omega$   
 $R_{DS(ON)2} = 50\text{m}\Omega$   
 $I_{D1} = 21\text{A}$   
 $I_{D2} = -18\text{A}$

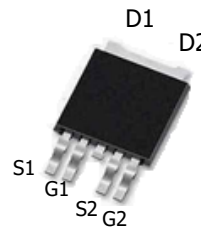

**•P Channel Absolute Maximum Ratings (T<sub>C</sub> =25°C)**

Parameter	Symbol	Rating	Unit
Drain-Source Voltage	V <sub>DS</sub>	-60	V
Gate-Source Voltage	V <sub>GS</sub>	±20	V
Continuous Drain Current	I <sub>D</sub> @T <sub>C</sub> =25°C	-18	A
	I <sub>D</sub> @T <sub>C</sub> =75°C	-13.6	A
	I <sub>D</sub> @T <sub>C</sub> =100°C	-11	A
Pulsed Drain Current ④	I <sub>DM</sub>	-54	A
Total Power Dissipation	P <sub>D</sub> @T <sub>C</sub> =25°C	50	W
Total Power Dissipation	P <sub>D</sub> @T <sub>A</sub> =25°C	2.0	W
Operating Junction Temperature	T <sub>J</sub>	-55 to 150	°C
Storage Temperature	T <sub>STG</sub>	-55 to 150	°C
Single Pulse Avalanche Energy	E <sub>AS</sub>	35	mJ

**•Thermal resistance**

Parameter	Symbol	Min.	Typ.	Max.	Unit
Thermal resistance, junction - case	R <sub>thJC</sub>	-	-	2.3	° C/W
Thermal resistance, junction - ambient	R <sub>thJA</sub>	-	-	62	° C/W
Soldering temperature, wavesoldering for 10s	T <sub>sold</sub>	-	-	265	° C

**•N Channel Electronic Characteristics**

Parameter	Symbol	Condition	Min.	Typ	Max.	Unit
Drain-Source Breakdown Voltage	BV <sub>DSS</sub>	V <sub>GS</sub> =0V, I <sub>D</sub> =250uA	60			V
Gate Threshold Voltage	V <sub>GS(TH)</sub>	V <sub>GS</sub> =V <sub>DS</sub> , I <sub>D</sub> =250uA	1.2	1.8	2.5	V
Drain-Source Leakage Current	I <sub>DSS</sub>	V <sub>DS</sub> =60V, V <sub>GS</sub> =0V			1.0	uA
Gate- Source Leakage Current	I <sub>GSS</sub>	V <sub>GS</sub> =±20V, V <sub>DS</sub> =0V			±100	nA
Static Drain-source On Resistance	R <sub>DS(ON)</sub>	V <sub>GS</sub> =10V, I <sub>D</sub> =8A		30	39	mΩ
		V <sub>GS</sub> =4.5V, I <sub>D</sub> =6A		36	48	mΩ
Forward Transconductance	g <sub>FS</sub>	V <sub>DS</sub> =25V, I <sub>D</sub> =5A		5		s
Source-drain voltage	V <sub>SD</sub>	I <sub>S</sub> =12A			1.28	V

**•N Channel Dynamic Characteristics**

Parameter	Symbol	Condition	Min.	Typ	Max.	Unit
-----------	--------	-----------	------	-----	------	------

Gate Resistance	R <sub>g</sub>	f = 1MHz		1.5		Ω
Input capacitance	C <sub>iss</sub>	f = 1MHz V <sub>DS</sub> =25V	-	1430	-	pF
Output capacitance	C <sub>oss</sub>		-	160	-	
Reverse transfer capacitance	C <sub>rss</sub>		-	115	-	
Total gate charge	Q <sub>g</sub>	V <sub>DD</sub> = 25V I <sub>D</sub> = 5A V <sub>GS</sub> = 10V	-	17	-	nC
Gate - Source charge	Q <sub>gs</sub>		-	4.1	-	
Gate - Drain charge	Q <sub>gd</sub>		-	2.5	-	

#### •P Channel Electronic Characteristics

Parameter	Symbol	Condition	Min.	Typ	Max.	Unit
Drain-Source Breakdown Voltage	BV <sub>DSS</sub>	V <sub>GS</sub> = 0V, I <sub>D</sub> = -250uA	-60			V
Gate Threshold Voltage	V <sub>GS(TH)</sub>	V <sub>GS</sub> = V <sub>DS</sub> , I <sub>D</sub> = -250uA	-1.2		-2.5	V
Drain-Source Leakage Current	I <sub>DSS</sub>	V <sub>DS</sub> = -60V, V <sub>GS</sub> = 0V			-1.0	uA
Gate- Source Leakage Current	I <sub>GSS</sub>	V <sub>GS</sub> = ±20V, V <sub>DS</sub> = 0V			±100	nA
Static Drain-source On Resistance	R <sub>DS(ON)</sub>	V <sub>GS</sub> = -10V, I <sub>D</sub> = -8A		38	46	mΩ
		V <sub>GS</sub> = -4.5V, I <sub>D</sub> = -6A		45	65	mΩ
Source-drain voltage	V <sub>SD</sub>	I <sub>S</sub> = -12A			-1.28	V
Forward Transconductance	g <sub>FS</sub>	V <sub>DS</sub> = -10V, I <sub>D</sub> = -5A		1.5		s

#### •P Channel Dynamic Characteristics

Parameter	Symbol	Condition	Min.	Typ	Max.	Unit
Gate Resistance	R <sub>g</sub>	f = 1MHz		7.5		Ω
Input capacitance	C <sub>iss</sub>	f = 1MHz V <sub>DS</sub> =25V	-	1650	-	pF
Output capacitance	C <sub>oss</sub>		-	330	-	
Reverse transfer capacitance	C <sub>rss</sub>		-	205	-	
Total gate charge	Q <sub>g</sub>	V <sub>DD</sub> = 25V I <sub>D</sub> = 5A V <sub>GS</sub> = 10V	-	20	-	nC
Gate - Source charge	Q <sub>gs</sub>		-	3.5	-	
Gate - Drain charge	Q <sub>gd</sub>		-	3.6	-	

•N Channel characteristics curve

Fig.1 Gate-Charge Characteristics

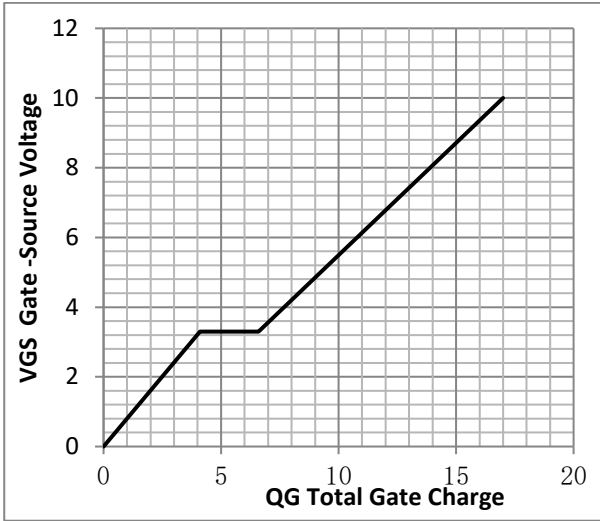

Fig.2 Capacitance Characteristics

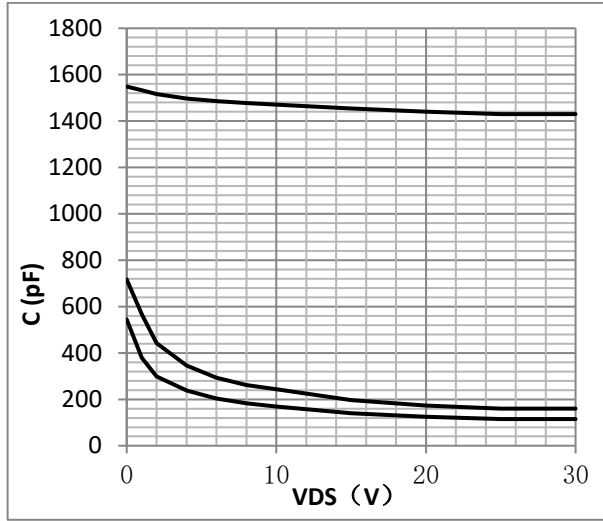

Fig.3 Maximum Continuous Drain Current

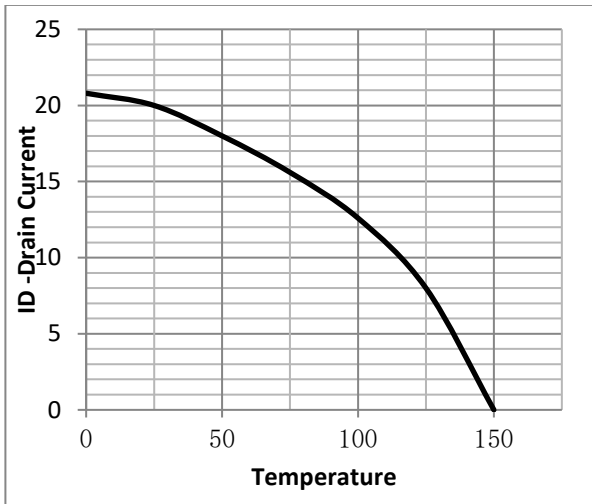

Fig.4 Typical output Characteristics

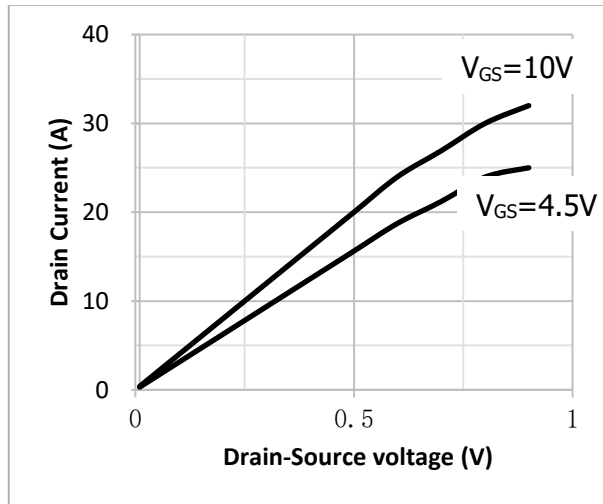

Fig.5 Threshold Voltage V.S Junction Temperature

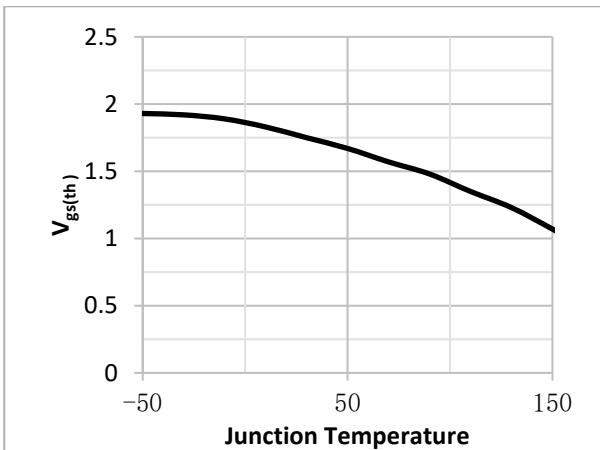

Fig.6 Resistance V.S Drain Current

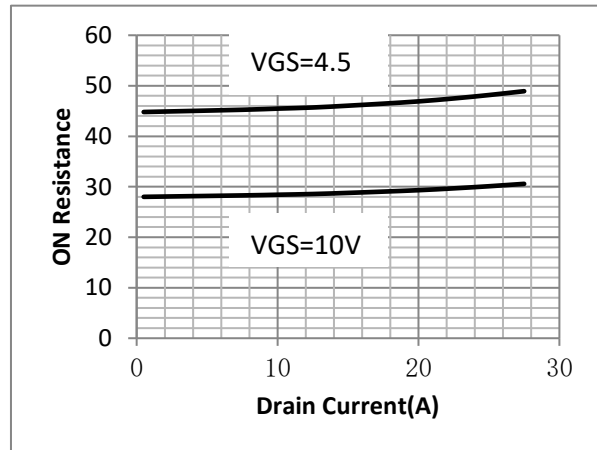

Fig.7 On-Resistance VS Gate Source Voltage

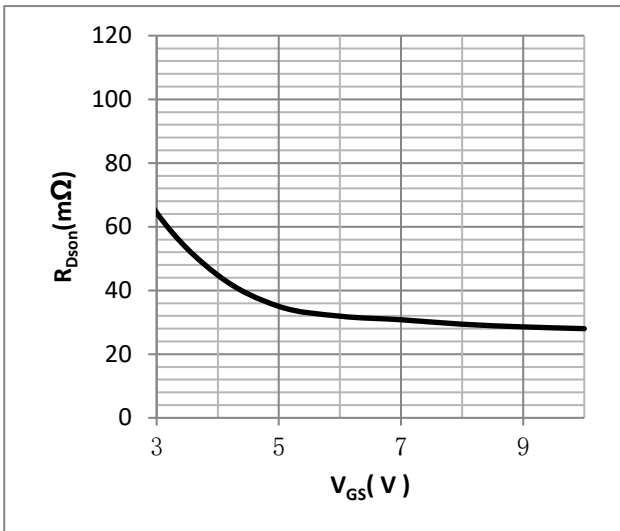

Fig.8 On-Resistance V.S Junction Temperature

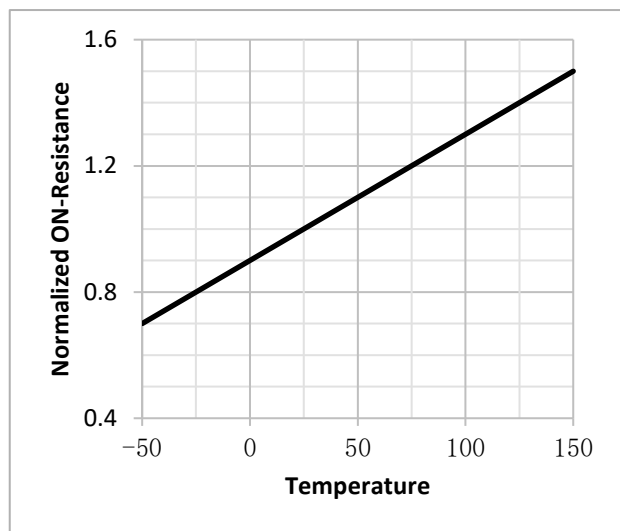

Fig.9 Power Dissipation

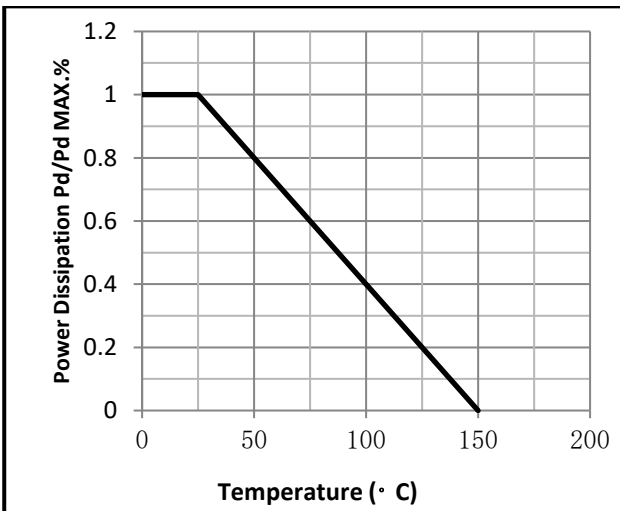
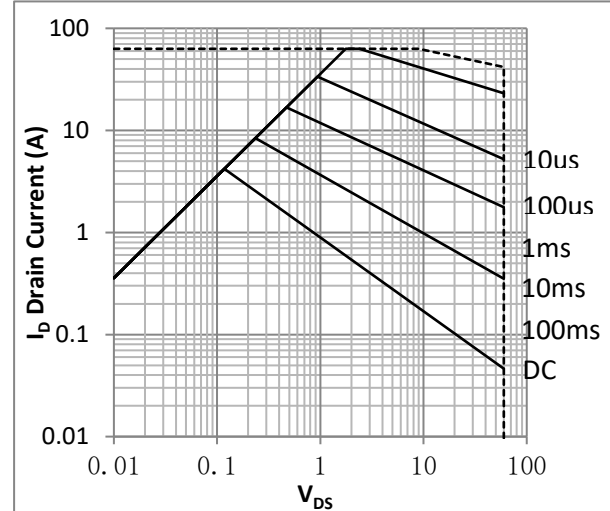

Fig.10 SOA Maximum Safe Operating Area



•P Channel characteristics curve

Fig.1 Gate-Charge Characteristics

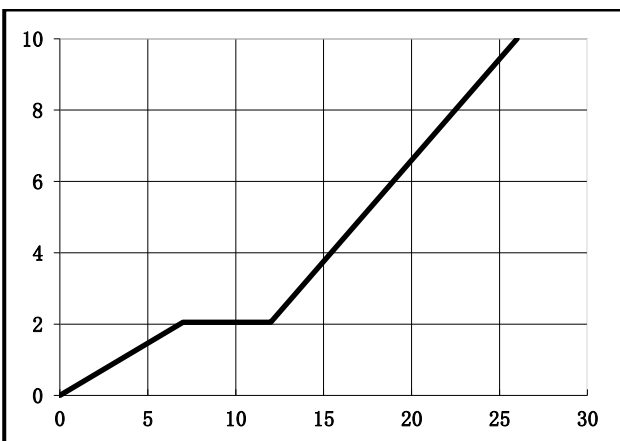

Fig.2 Capacitance Characteristics

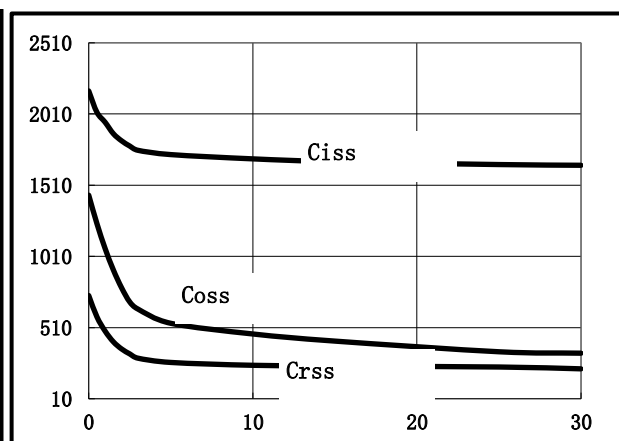

Fig.3 Maximum Continuous Drain Current

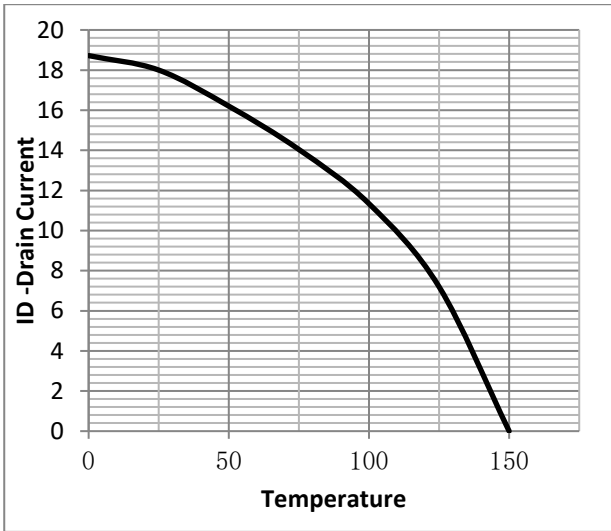

Fig.4 Typical output Characteristics

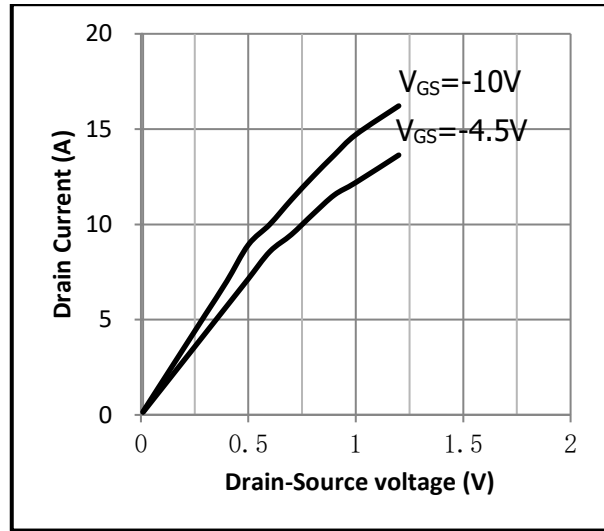

Fig.5 Threshold Voltage V.S Junction Temperature

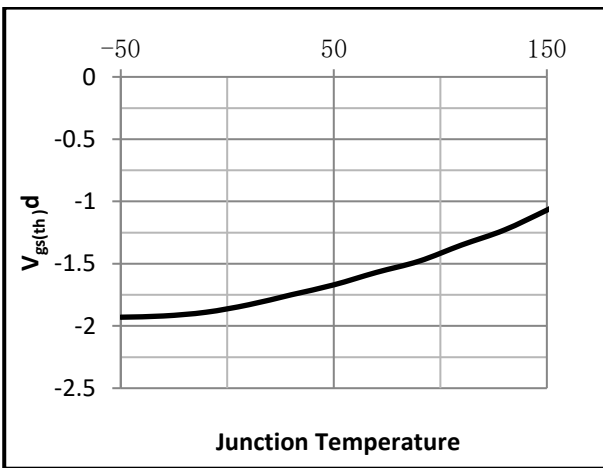

Fig.6 Resistance V.S Drain Current

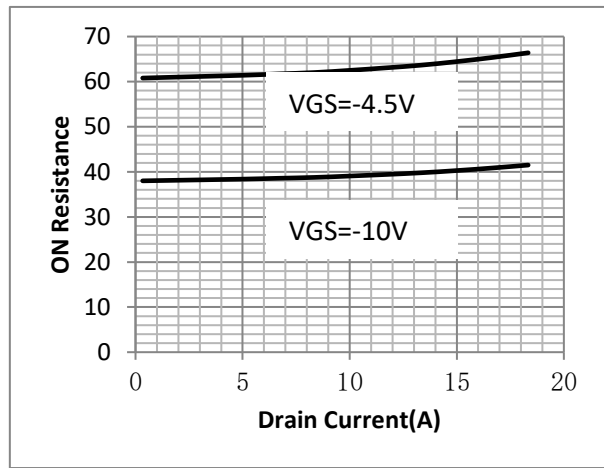

Fig.7 On-Resistance VS Gate Source Voltage

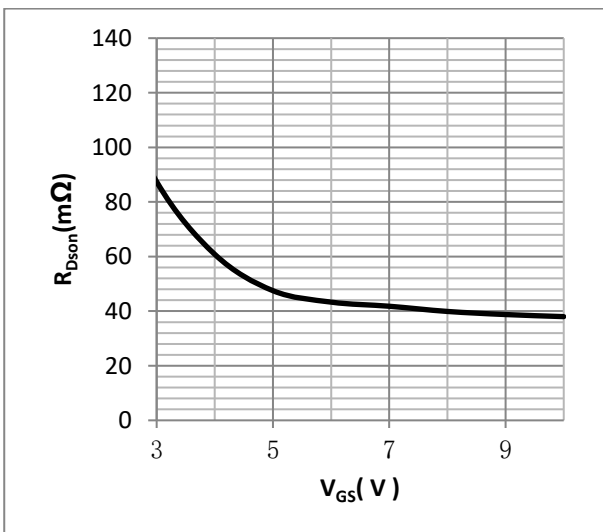

Fig.8 On-Resistance V.S Junction Temperature

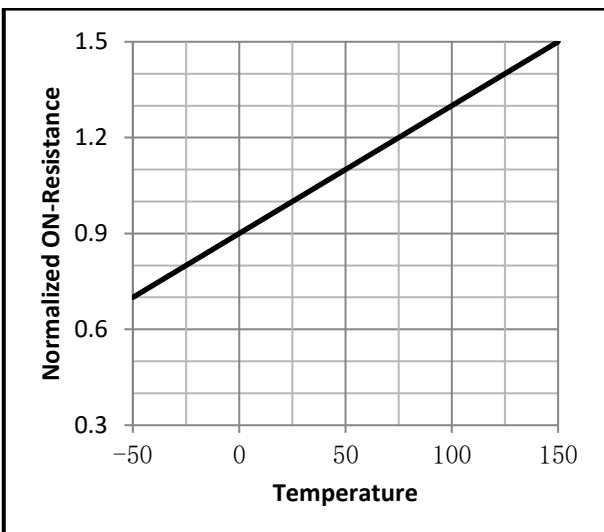

Fig.9 Power Dissipation

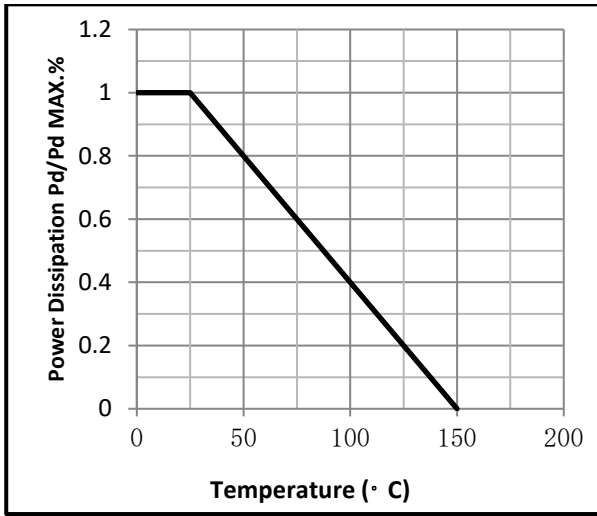
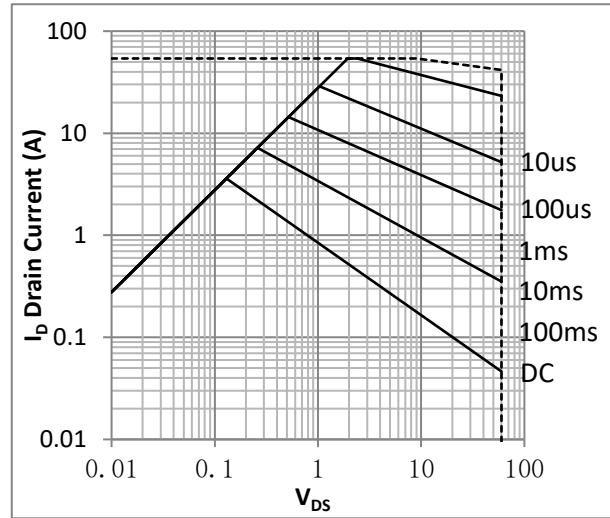

Fig.10 SOA Maximum Safe Operating Area



•Test Circuit

Fig.1 Switching Time Measurement Circuit

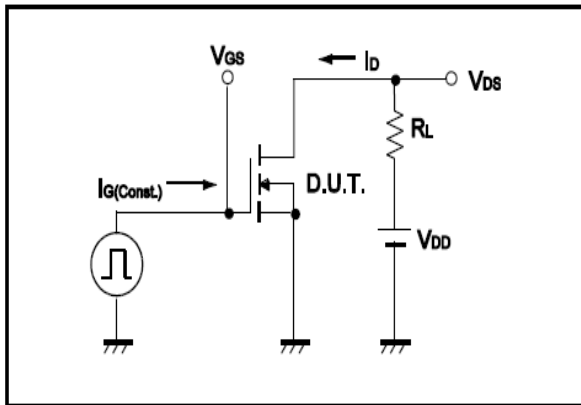

Fig.2 Gate Charge Waveform

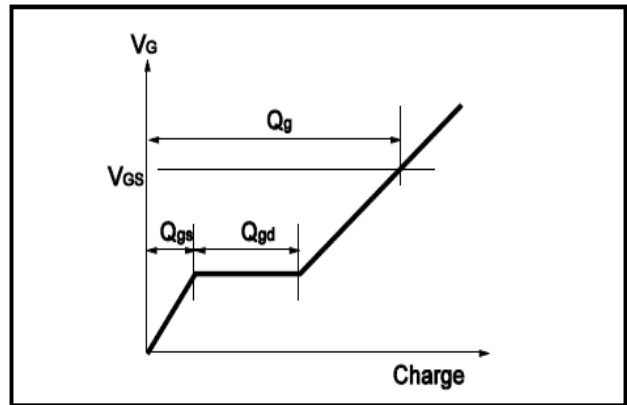

Fig.3 Switching Time Measurement Circuit

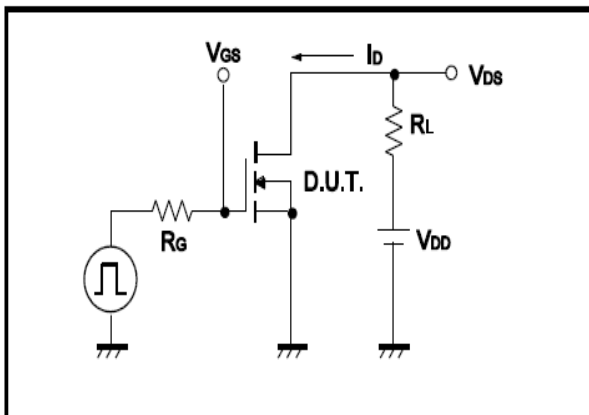

Fig.4 Gate Charge Waveform

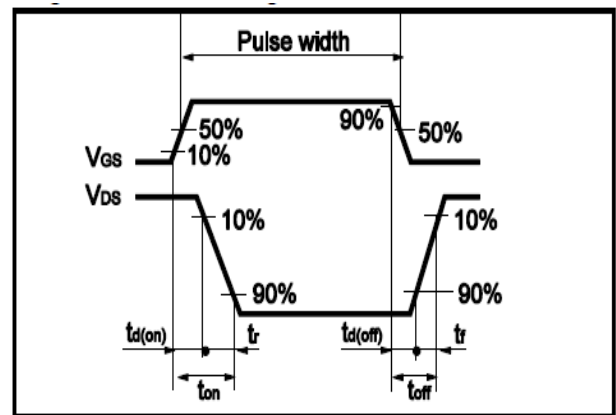

Fig.5 Avalanche Measurement Circuit

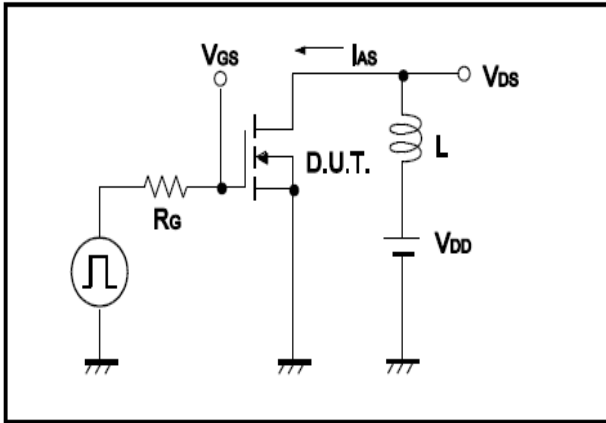
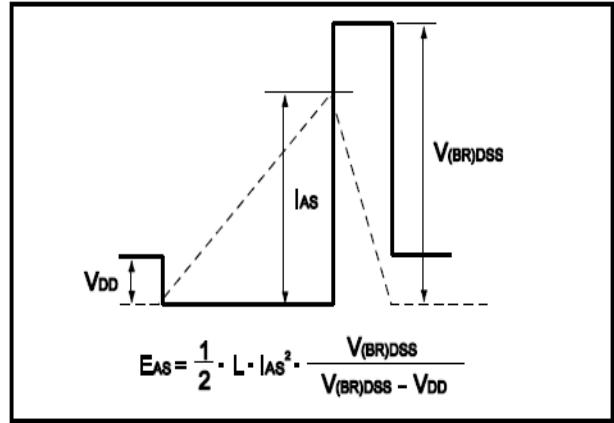

Fig.6 Avalanche Waveform







●Dimensions (TO-252-4)

Unit: mm

