

**• General Description**

The ZM035P03N combines advanced trench MOSFET technology with a low resistance package to provide extremely low  $R_{DS(ON)}$ .

**• Features**

- Advance high cell density Trench technology
- Low  $R_{DS(ON)}$  to minimize conductive loss
- Low Gate Charge for fast switching
- Low Thermal resistance

**• Application**

- Synchronous Rectification for AC-DC/DC-DC converter
- Oring switches
- BLDC Motor driver

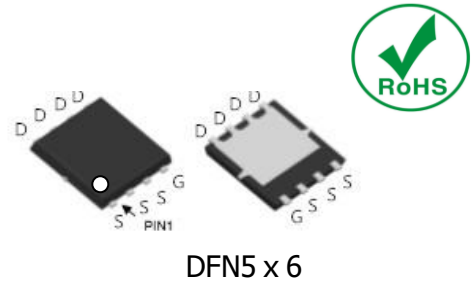
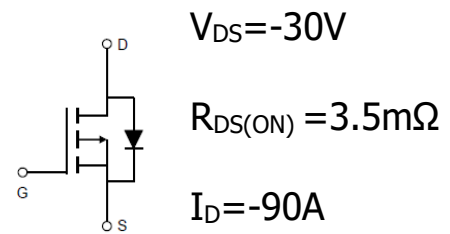
**• Product Summary**

**• Ordering Information:**

Part NO.	ZM035P03N
Marking	ZM035P03
Packing Information	REEL TAPE
Basic ordering unit (pcs)	3000

**• Absolute Maximum Ratings ( $T_C = 25^\circ C$ )**

Parameter	Symbol	Rating	Unit
Drain-Source Voltage	$V_{DS}$	-30	V
Gate-Source Voltage	$V_{GS}$	$\pm 25$	V
Continuous Drain Current	$I_{D@TC=25^\circ C}$	-90	A
	$I_{D@TC=75^\circ C}$	-68	A
	$I_{D@TC=100^\circ C}$	-56	A
Pulsed Drain Current ①	$I_{DM}$	-200	A
Total Power Dissipation	$P_D@TC=25^\circ C$	85	W
Total Power Dissipation	$P_D@TA=25^\circ C$	3.4	W
Operating Junction Temperature	$T_J$	-55 to 150	$^\circ C$
Storage Temperature	$T_{STG}$	-55 to 150	$^\circ C$
Single Pulse Avalanche Energy@L=0.1mH	$E_{AS}$	180	mJ
Avalanche Current@L=0.1mH	$I_{AS}$	60	A

**•Thermal resistance**

Parameter	Symbol	Min.	Typ.	Max.	Unit
Thermal resistance, junction - case	$R_{thJC}$	-	-	1.5	$^{\circ}C/W$
Thermal resistance, junction - ambient	$R_{thJA}$	-	-	37	$^{\circ}C/W$
Soldering temperature, wave soldering for 10s	$T_{sold}$	-	-	265	$^{\circ}C$

**•Electronic Characteristics**

Parameter	Symbol	Condition	Min.	Typ	Max.	Unit
Drain-Source Breakdown Voltage	$BV_{DSS}$	$V_{GS}=0V, I_D=-250\mu A$	-30			V
Gate Threshold Voltage	$V_{GS(TH)}$	$V_{GS}=V_{DS}, I_D=-250\mu A$	-1.2		-2.5	V
Drain-Source Leakage Current	$I_{DSS}$	$V_{DS}=-30V, V_{GS}=0V$			1.0	$\mu A$
Gate- Source Leakage Current	$I_{GSS}$	$V_{GS}=\pm 20V, V_{DS}=0V$			$\pm 100$	nA
Static Drain-source On Resistance	$R_{DS(ON)}$	$V_{GS}=-10V, I_D=-24A$		3.5	4.5	m $\Omega$
		$V_{GS}=-4.5V, I_D=-12A$		6	7.2	m $\Omega$
Forward Transconductance	$g_{FS}$	$V_{DS}=-25V, I_D=-10A$		20		S
Source-drain voltage	$V_{SD}$	$I_S=-24A$			1.28	V

**•Electronic Characteristics**

Parameter	Symbol	Condition	Min.	Typ	Max.	Unit
Input capacitance	$C_{iss}$	$V_{GS}=0V, V_{DS}=20V$ $f = 1MHz$	-	4500	-	pF
Output capacitance	$C_{oss}$		-	398	-	
Reverse transfer capacitance	$C_{rss}$		-	157	-	

**•Gate Charge characteristics( $T_a = 25^{\circ}C$ )**

Parameter	Symbol	Condition	Min.	Typ	Max.	Unit
Total gate charge	$Q_g$	$V_{DD} = 30V$ $I_D = 20A$ $V_{GS} = 10V$	-	84	-	nC
Gate - Source charge	$Q_{gs}$		-	20	-	
Gate - Drain charge	$Q_{gd}$		-	9.7	-	

Note: ① Pulse Test : Pulse width  $\leq 300\mu s$ , Duty cycle  $\leq 2\%$  ;

Fig.1 Gate-Charge Characteristics

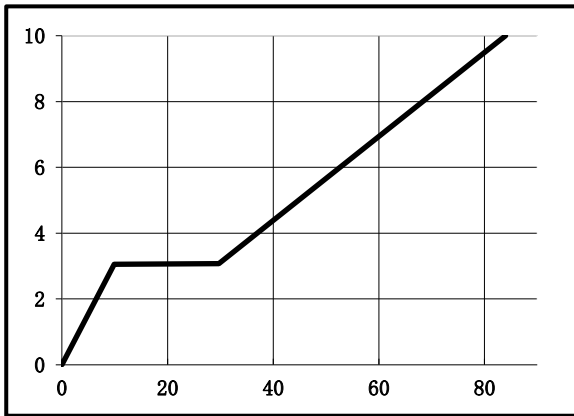

Fig.2 Capacitance Characteristics

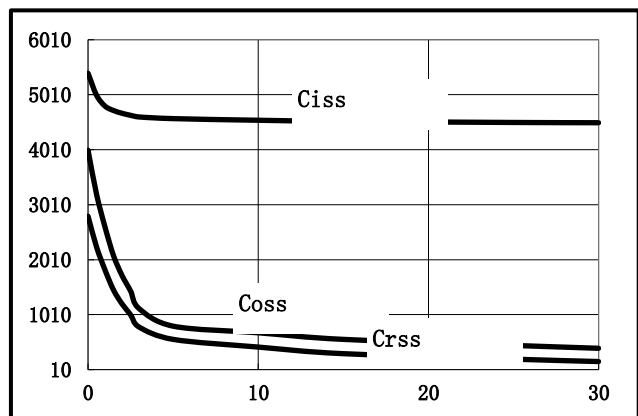

Fig.3 Power Dissipation

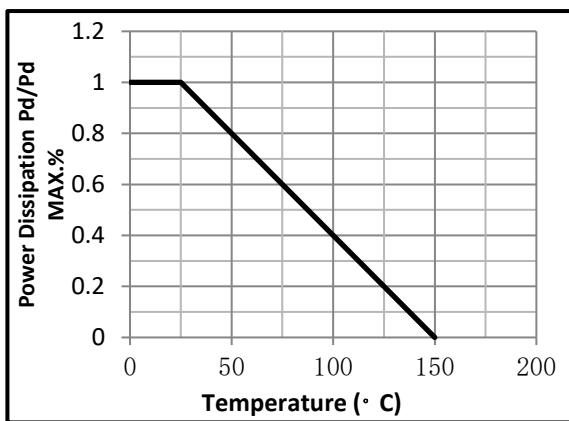

Fig.4 Typical output Characteristics

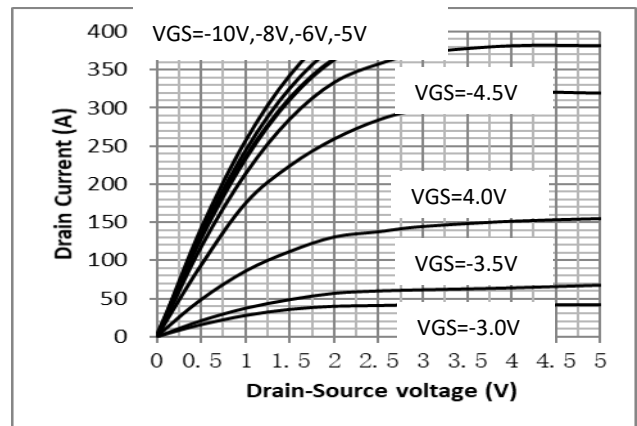

Fig.5 Threshold Voltage V.S Junction Temperature

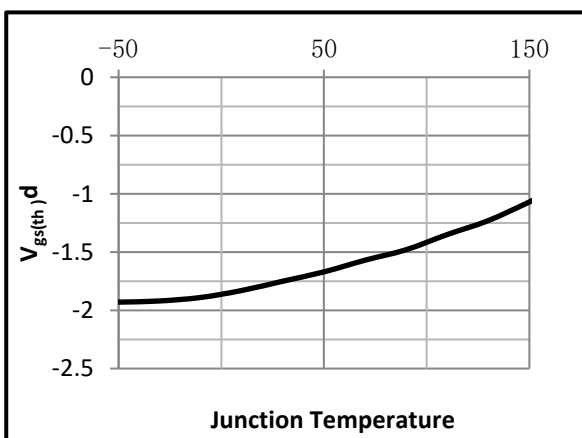
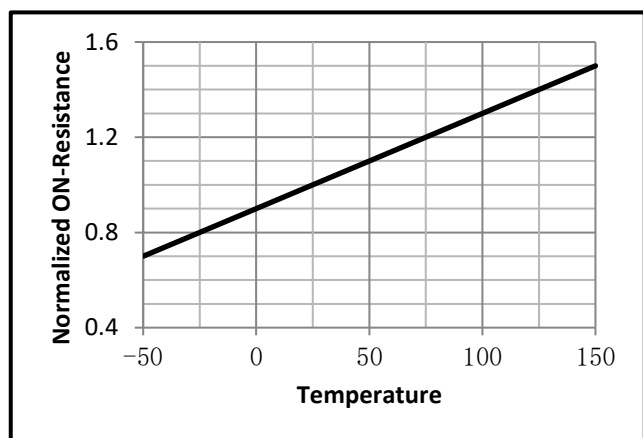

Fig.6 Resistance V.S Drain Current



ig.7 On-Resistance VS Gate Source Voltage

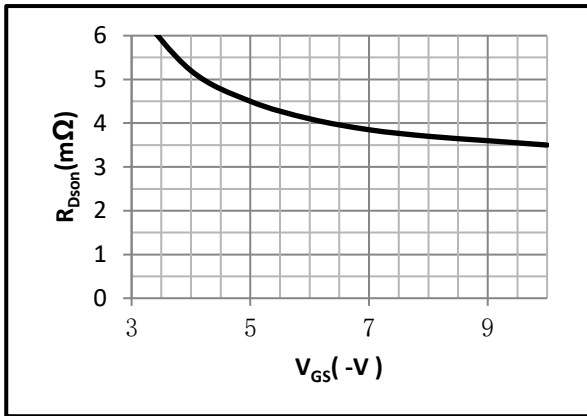

Fig.8 On-Resistance V.S Junction Temperature

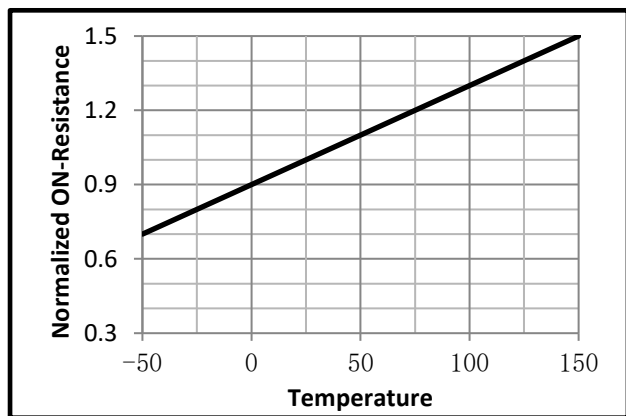

Fig.9 Maximum Forward Biased Safe Operating Area Fig.10 ID-Junction Temperature

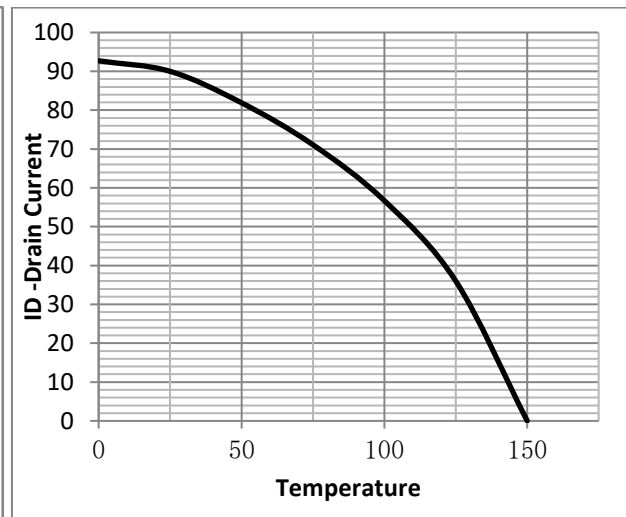
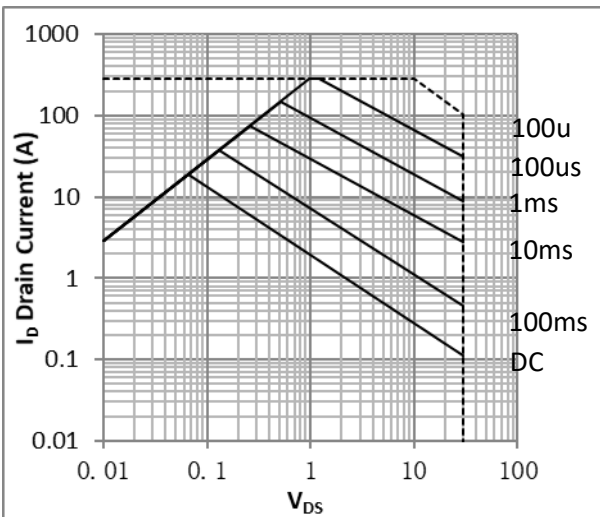

Fig.9 Switching Time Measurement Circuit

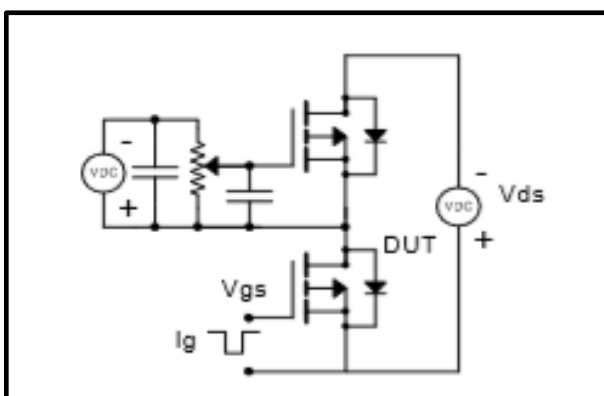

Fig.10 Gate Charge Waveform

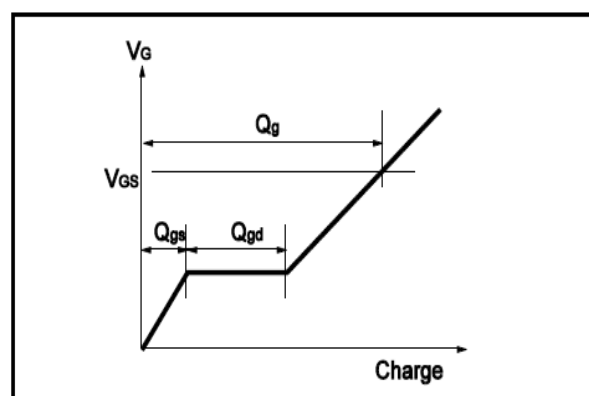

Fig.11 Switching Time Measurement Circuit

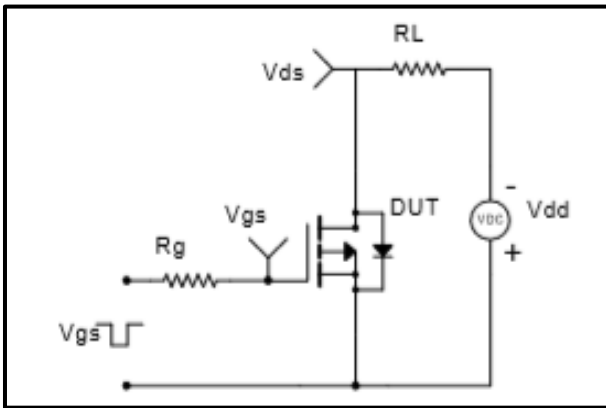
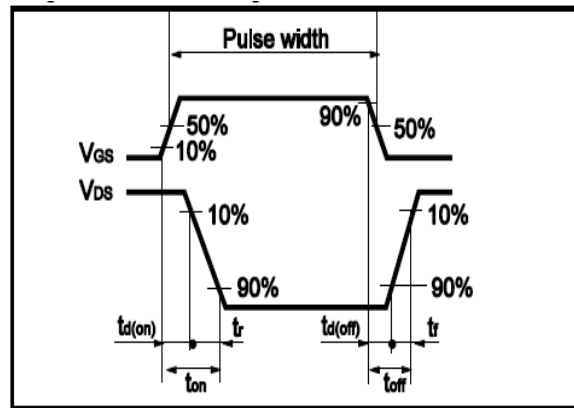

Fig.12 Gate Charge Waveform





•Dimensions (DFN5x6)

Unit: mm

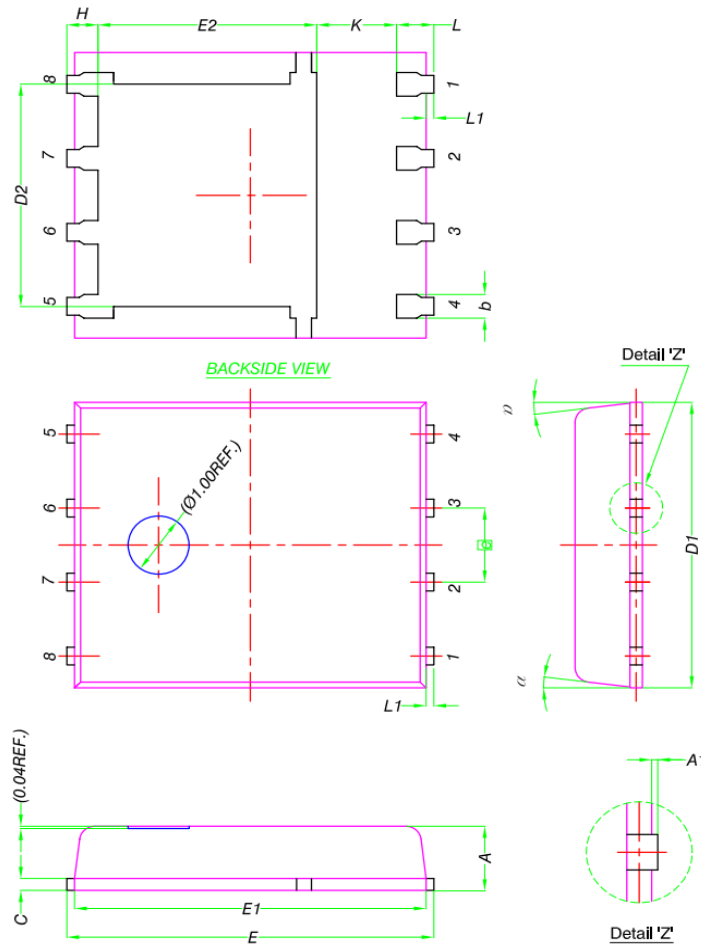

DIM.	MILLIMETERS		
	MIN.	NOM.	MAX.
A	0.90	1.00	1.10
A1	0	-	0.05
b	0.33	0.41	0.51
C	0.20	0.25	0.30
D1	4.80	4.90	5.00
D2	3.61	3.81	3.96
E	5.90	6.00	6.10
E1	5.70	5.75	5.80
E2	3.38	3.58	3.78
$\square$ e	1.27 BSC		
H	0.41	0.51	0.61
K	1.10	-	-
L	0.51	0.61	0.71
L1	0.06	0.13	0.20
$\alpha$	0°	-	12°