

• General Description

It combines advanced trench MOSFET technology with a low resistance package to provide extremely low $R_{DS(ON)}$.

• Features

- Low $R_{DS(ON)}$ to minimize conductive loss
- Low Gate Charge for fast switching
- Low Thermal resistance

• Application

- SMPS 2nd Synchronous Rectifier
- BLDC Motor driver
- DC/DC

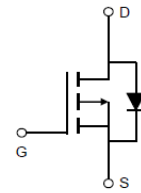
• Product Summary

 $V_{DS} = -60V$
 $R_{DS(ON)} = 12m\Omega$
 $I_D = -67A$

TO-263

• Ordering Information:

Part NO.	ZM120P06B
Marking	ZM120P06
Packing Information	REEL TAPE
Basic ordering unit (pcs)	800

• Absolute Maximum Ratings ($T_C = 25^\circ C$)

Parameter	Symbol	Rating	Unit
Drain-Source Voltage	V_{DS}	-60	V
Gate-Source Voltage	V_{GS}	± 25	V
Continuous Drain Current	$I_D @ T_C = 25^\circ C$	-67	A
	$I_D @ T_C = 75^\circ C$	-51	A
	$I_D @ T_C = 100^\circ C$	-42	A
Pulsed Drain Current ^①	I_{DM}	-201	A
Total Power Dissipation	$P_D @ T_C = 25^\circ C$	55	W
Total Power Dissipation	$P_D @ T_A = 25^\circ C$	3.5	W
Operating Junction Temperature	T_J	-55 to 150	$^\circ C$
Storage Temperature	T_{STG}	-55 to 150	$^\circ C$
Single Pulse Avalanche Energy @ $L = 0.1mH$	E_{AS}	300	mJ

●Thermal resistance

Parameter	Symbol	Min.	Typ.	Max.	Unit
Thermal resistance, junction - case	R _{thJC}	-	-	2.1	° C/W
Thermal resistance, junction - ambient	R _{thJA}	-	-	38	° C/W
Soldering temperature, wavesoldering for 10s	T _{sold}	-	-	265	° C

●Electronic Characteristics

Parameter	Symbol	Condition	Min.	Typ	Max.	Unit
Drain-Source Breakdown Voltage	BV _{DSS}	V _{GS} =0V, I _D =-250uA	-60			V
Gate Threshold Voltage	V _{GS(TH)}	V _{GS} =V _{DS} , I _D =-250uA	-1.2		-2.5	V
Drain-Source Leakage Current	I _{DSS}	V _{DS} =-60V, V _{GS} =0V			-1.0	uA
Gate- Source Leakage Current	I _{GSS}	V _{GS} =±25V, V _{DS} =0V			±100	nA
Static Drain-source On Resistance	R _{DS(ON)}	V _{GS} =-10V, I _D =-30A		12	15.6	mΩ
		V _{GS} =-4.5V, I _D =-20A		15	20	mΩ
Forward Transconductance	g _{FS}	V _{DS} =-10V, I _D =-30A		25		s

●Electronic Characteristics

Parameter	Symbol	Condition	Min.	Typ	Max.	Unit
Input capacitance	C _{iss}	f = 1MHz V _{DS} =-25V	-	11800	-	pF
Output capacitance	C _{oss}		-	2008	-	
Reverse transfer capacitance	C _{rss}		-	1506	-	

●Gate Charge characteristics(T_a = 25°C)

Parameter	Symbol	Condition	Min.	Typ	Max.	Unit
Total gate charge	Q _g	V _{DD} =-25V	-	200	-	nC
Gate - Source charge	Q _{gs}	I _D =-10A	-	32	-	
Gate - Drain charge	Q _{gd}	V _{GS} =-10V	-	47	-	

Note: ① Pulse Test : Pulse width ≤ 300μs, Duty cycle ≤ 2% ;

② Device mounted on FR-4 substrate PC board, 2oz copper, with thermal bias to bottom layer 1inch square copper plate;

Fig.1 Gate-Charge Characteristics

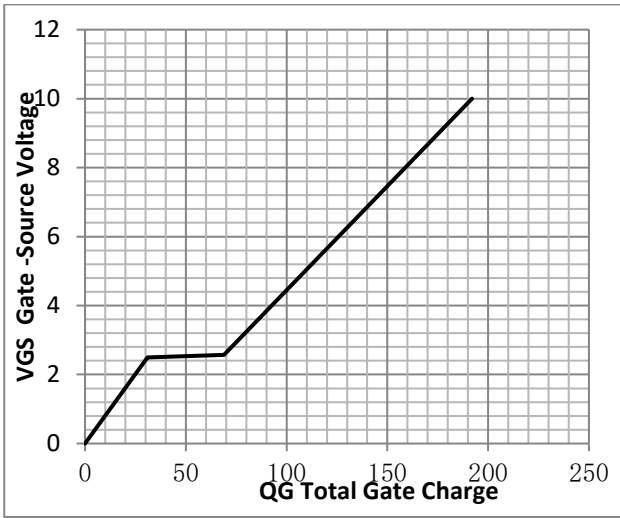

Fig.2 Capacitance Characteristics

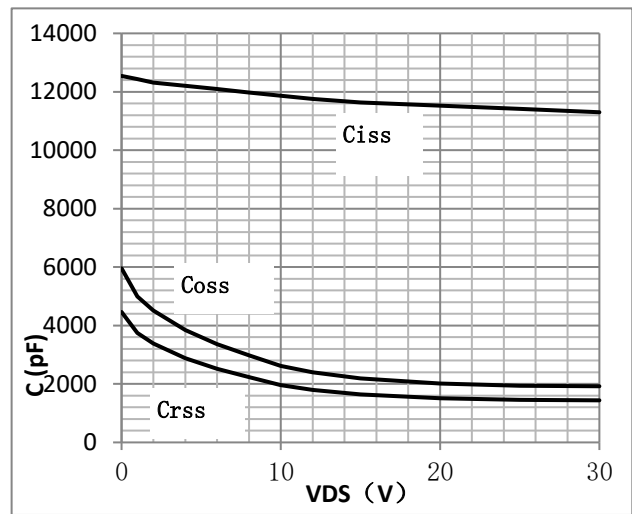

Fig.3 Power Dissipation

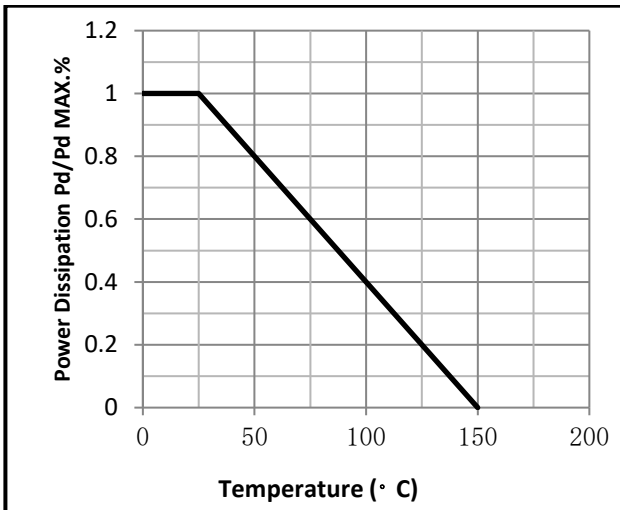

Fig.4 Typical output Characteristics

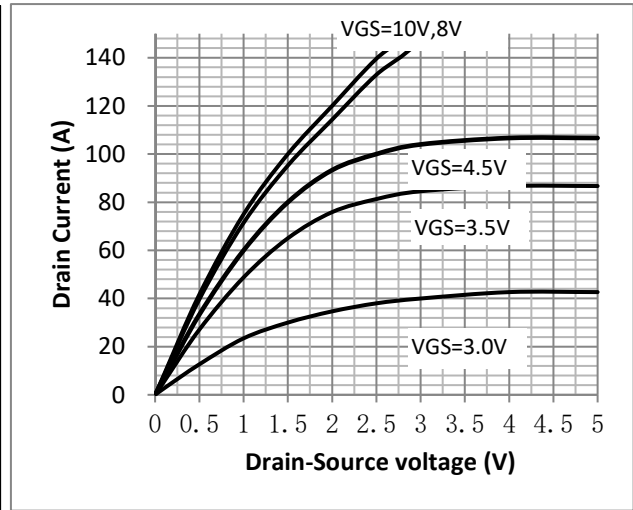

Fig.5 Threshold Voltage V.S Junction Temperature

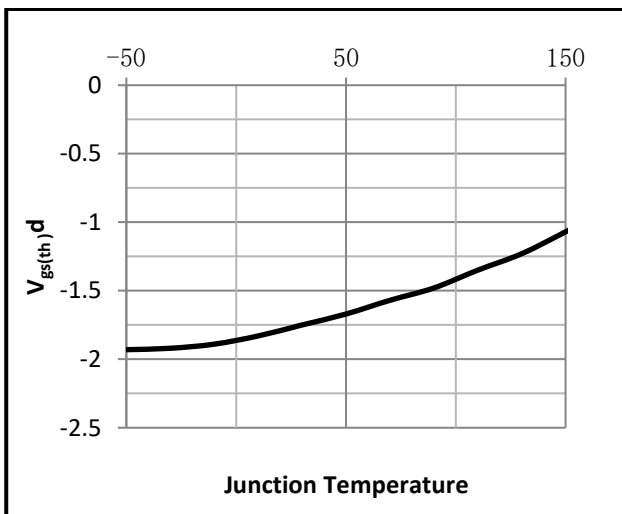

Fig.6 Resistance V.S Drain Current

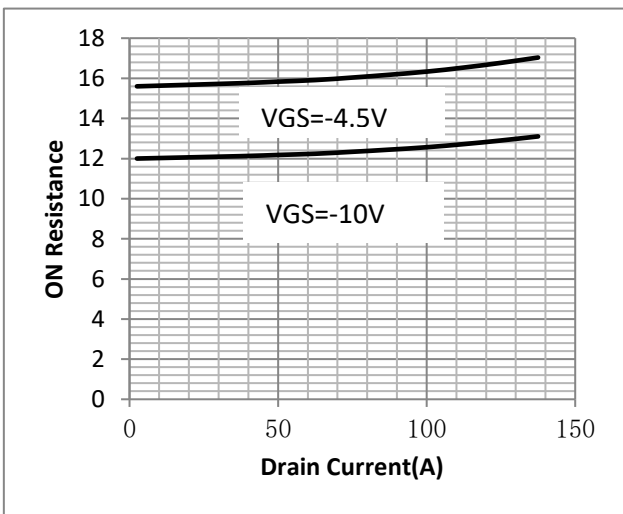

Fig.7 On-Resistance VS Gate Source Voltage

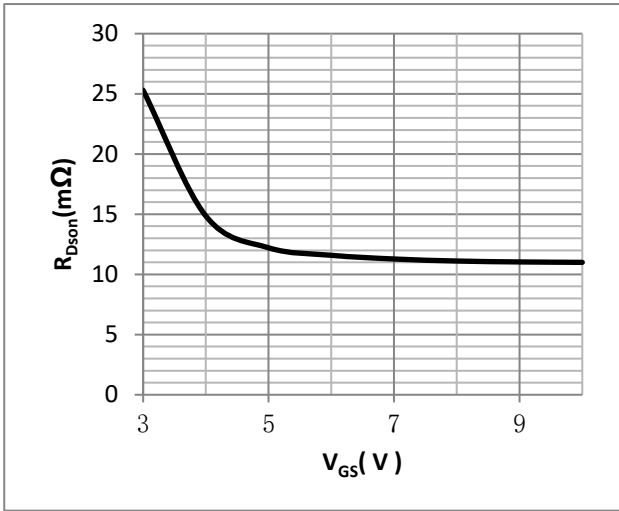

Fig.8 On-Resistance V.S Junction Temperature

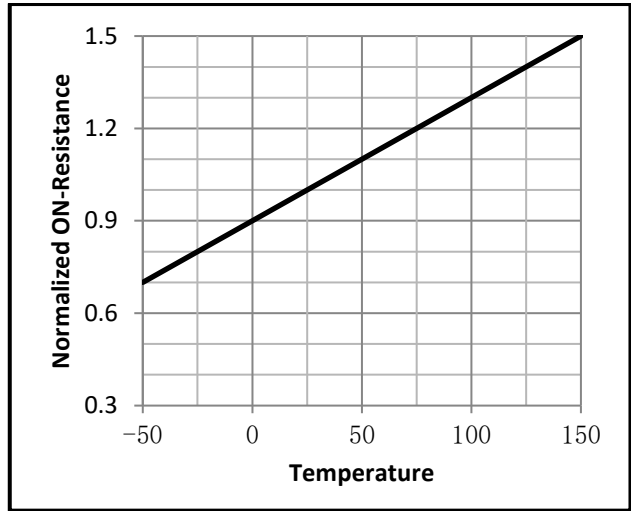

Fig.9 Maximum Forward Biased Safe Operating Area Fig.10 ID-Junction Temperature

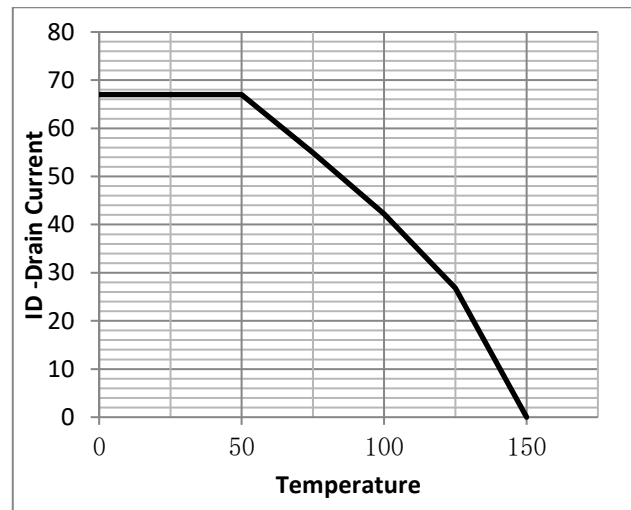
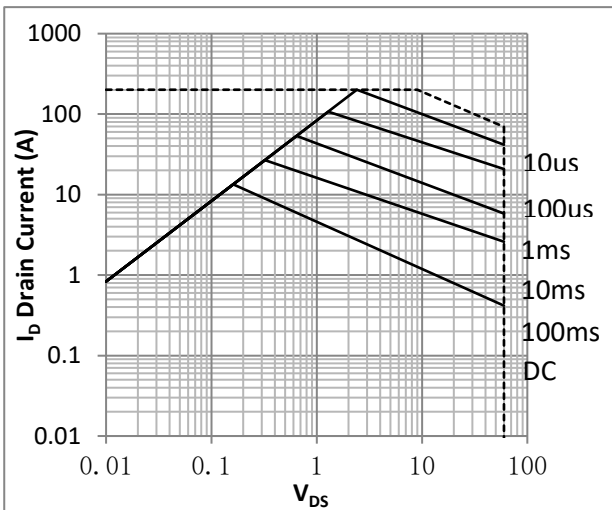

Fig.11 Switching Time Measurement Circuit

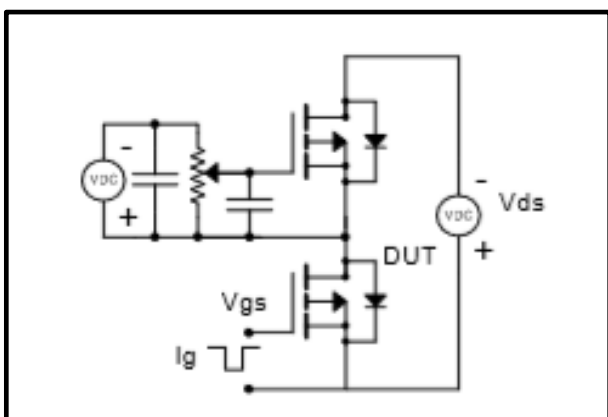

Fig.12 Gate Charge Waveform

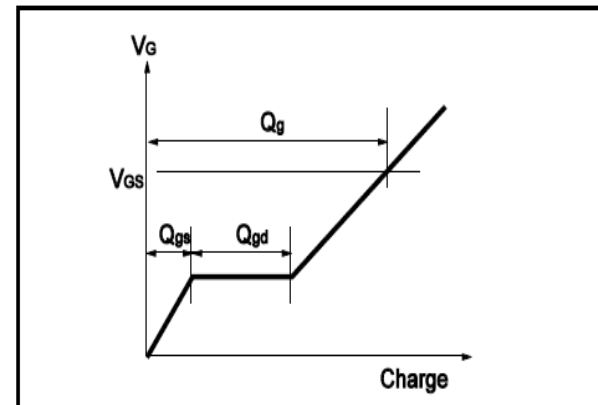

Fig.13 Switching Time Measurement Circuit

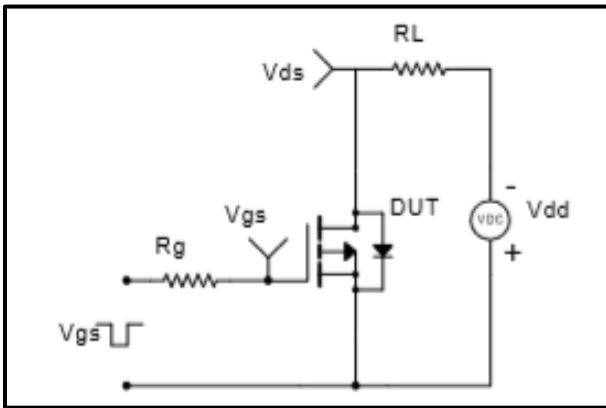
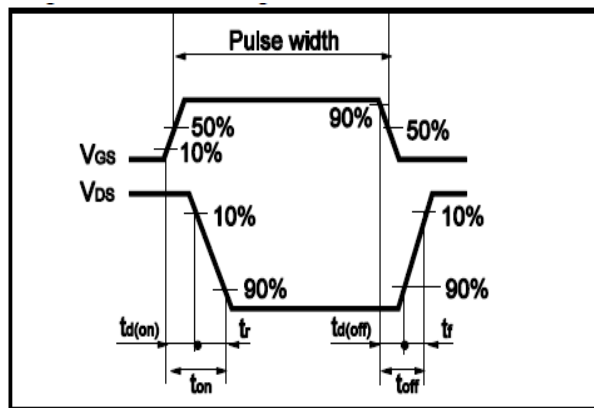

Fig.14 Gate Charge Waveform





• Dimensions (TO-263)

Unit: mm

SYMBOL	MIN	TYP	MAX	SYMBOL	MIN	TYP	MAX
A	4.42		4.72	E	8.99		9.29
B	1.22		1.32	e1	2.44		2.64
b	0.76		0.86	e2	4.98		5.18
b1	1.22		1.32	L1	15.19		15.79
b2	0.33		0.43	L2	2.29		2.79
C	1.22		1.32	L3	1.3		1.75
D	9.95		10.25				

