

**• General Description**

It combines advanced SGT MOSFET technology with a low resistance package to provide extremely low $R_{DS(ON)}$.

• Features

- Advance high cell density Trench technology
- Low $R_{DS(ON)}$ to minimize conductive loss
- Low Gate Charge for fast switching
- Low Thermal resistance

• Application

- MB/VGA Vcore
- SMPS 2nd Synchronous Rectifier
- POL application
- BLDC Motor driver

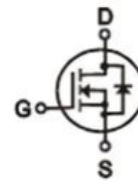
• Product Summary

$V_{DS} = 30V$

$R_{DS(ON)} = 5.1m\Omega$

$I_D = 45A$

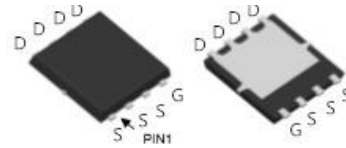

DFN5 x 6

• Ordering Information:

Part NO.	ZMS051N03N
Marking	ZMS051N03
Packing Information	REEL TAPE
Basic ordering unit (pcs)	3000

• Absolute Maximum Ratings (T_C=25°C)

Parameter	Symbol	Rating	Unit
Drain-Source Voltage	V_{DS}	30	V
Gate-Source Voltage	V_{GS}	±20	V
Continuous Drain Current	$I_D @TC=25^\circ C$	45	A
	$I_D @TC=75^\circ C$	34	A
	$I_D @TC=100^\circ C$	28	A
Pulsed Drain Current ①	I_{DM}	135	A
Total Power Dissipation	$P_D @TC=25^\circ C$	62.5	W
Total Power Dissipation	$P_D @TA=25^\circ C$	2.5	W
Operating Junction Temperature	T_J	-55 to 150	°C
Storage Temperature	T_{STG}	-55 to 150	°C
Single Pulse Avalanche Energy	E_{AS}	40	mJ



•Thermal resistance

Parameter	Symbol	Min.	Typ.	Max.	Unit
Thermal resistance, junction - case	R_{thJC}	-	-	2.0	$^{\circ}C/W$
Thermal resistance, junction - ambient	R_{thJA}	-	-	50	$^{\circ}C/W$
Soldering temperature, wave soldering for 10s	T_{sold}	-	-	265	$^{\circ}C$

•Electronic Characteristics

Parameter	Symbol	Condition	Min.	Typ	Max.	Unit
Drain-Source Breakdown Voltage	BV_{DSS}	$V_{GS} = 0V, I_D = 250\mu A$	30			V
Gate Threshold Voltage	$V_{GS(TH)}$	$V_{GS} = V_{DS}, I_D = 250\mu A$	1.5	1.8	2.5	V
Drain-Source Leakage Current	I_{DSS}	$V_{DS} = 30V, V_{GS} = 0V$			1.0	μA
Gate- Source Leakage Current	I_{GSS}	$V_{GS} = \pm 20V, V_{DS} = 0V$			± 100	nA
Static Drain-source On Resistance	$R_{DS(ON)}$	$V_{GS} = 10V, I_D = 20A$		5.1	7.2	m Ω
		$V_{GS} = 4.5V, I_D = 10A$		7.0	9.0	m Ω
Forward Transconductance	g_{FS}	$V_{DS} = 25V, I_D = 4A$		5		S
Source-drain voltage	V_{SD}	$I_S = 20A$			1.28	V

•Electronic Characteristics

Parameter	Symbol	Condition	Min.	Typ	Max.	Unit
Input capacitance	C_{iss}	$f = 1MHz$	-	675	-	pF
Output capacitance	C_{oss}		-	186	-	
Reverse transfer capacitance	C_{rss}		-	16	-	

•Gate Charge characteristics($T_a = 25^{\circ}C$)

Parameter	Symbol	Condition	Min.	Typ	Max.	Unit
Total gate charge	Q_g	$V_{DD} = 15V$	-	12	-	nC
Gate - Source charge	Q_{gs}	$I_D = 20A$	-	2.6	-	
Gate - Drain charge	Q_{gd}	$V_{GS} = 10V$	-	1.4	-	
Turn-ON Delay time	$t_{D(on)}$	$V_{DD} = 15V$		14		
Turn-ON Rise time	t_r	$I_D = 20A$		21		
Turn-Off Delay time	$t_{D(off)}$	$V_{GS} = 4.5V$		26		
Turn-Off Fall time	t_f	$R_{G,ext} = 2\Omega$		7.5		



Body Diode Reverse Recovery Time	trr	IF=20A, dI/dt=100A/μs	10	
Body Diode Reverse Recovery Charge	Qrr		18	

Note: ① Pulse Test : Pulse width ≤ 300μs, Duty cycle ≤ 2% ;

Fig.1 Power Dissipation

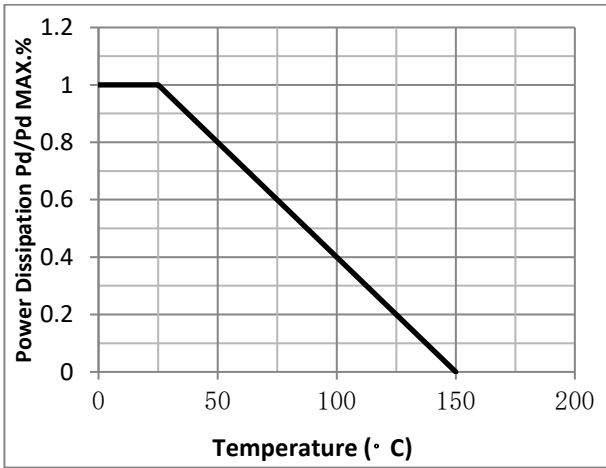

Fig.2 Typical output Characteristics

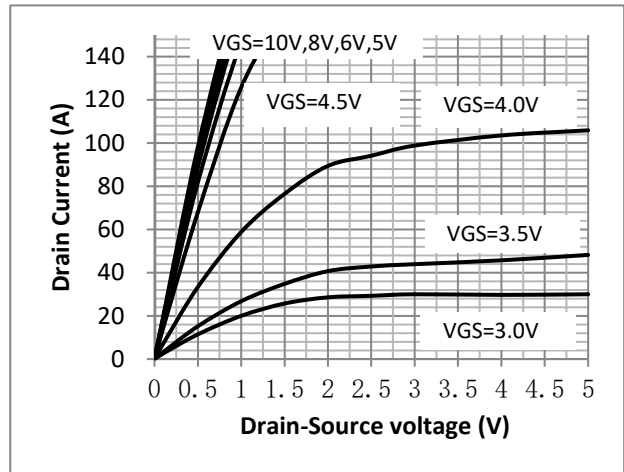

Fig.3 Threshold Voltage V.S Junction Temperature

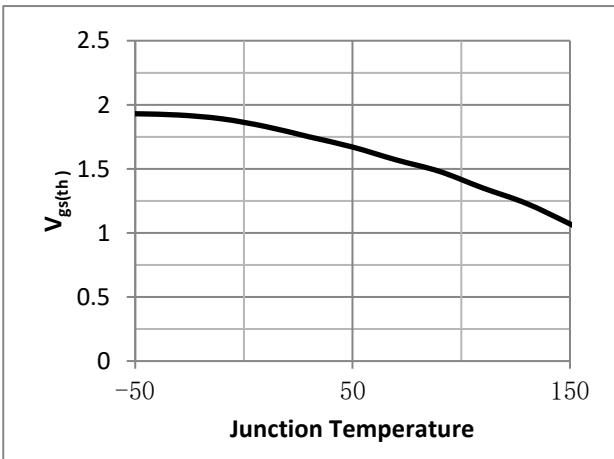

Fig.4 Resistance V.S Drain Current

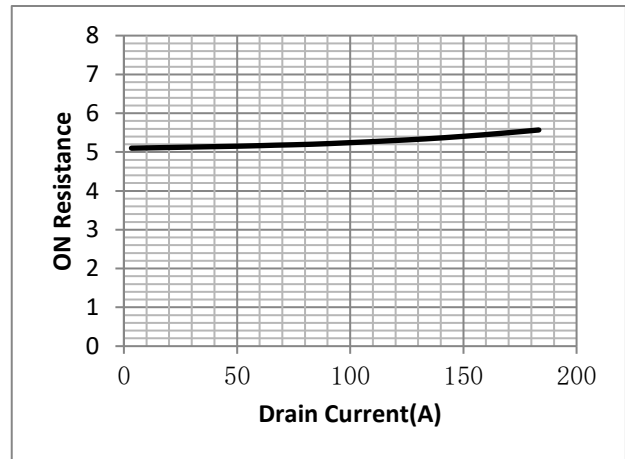



Fig.5 On-Resistance VS Gate Source Voltage

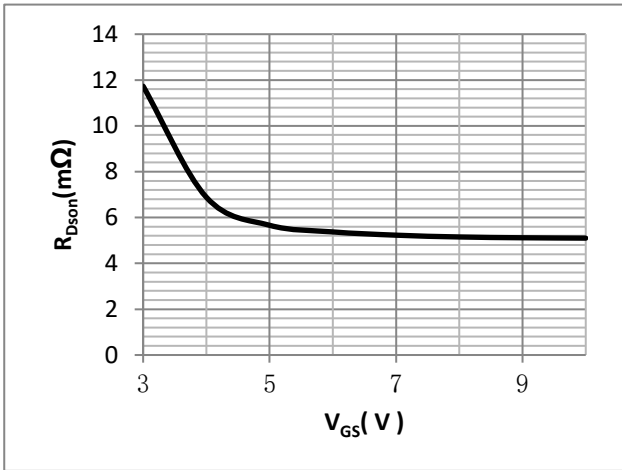

Fig.6 On-Resistance V.S Junction Temperature

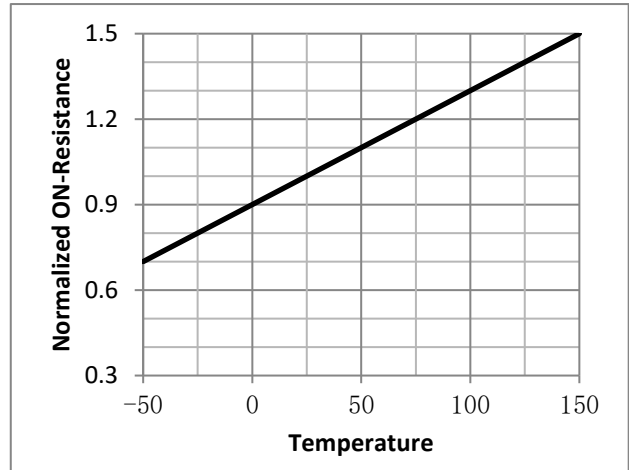

Fig.7 Gate Charge Characteristics

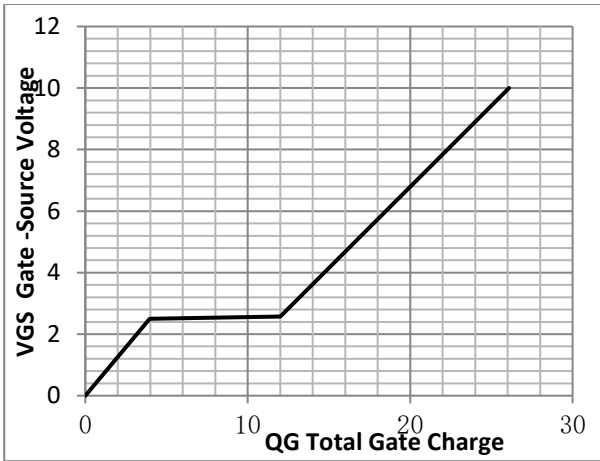

Fig.8 Capacitance vs Vds

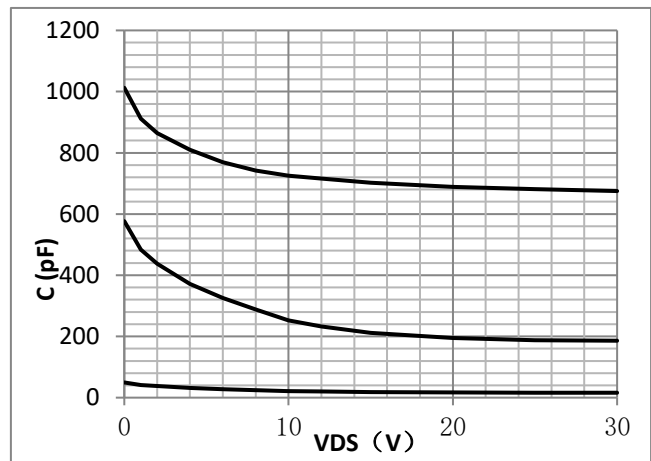

Fig.9 SOA Maximum Safe Operating Area

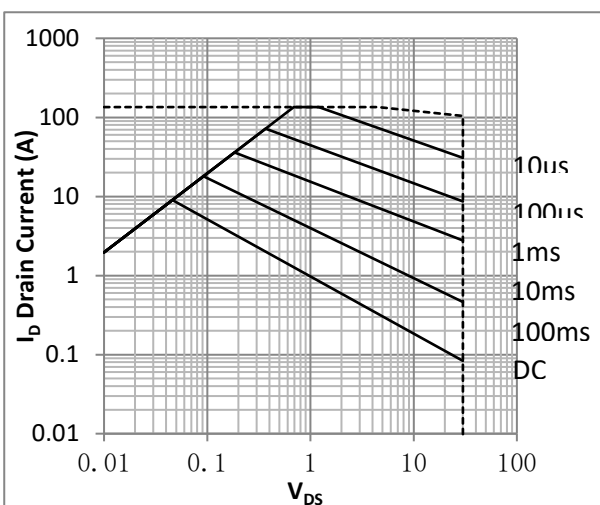

Fig.10 I_D-Junction Temperature

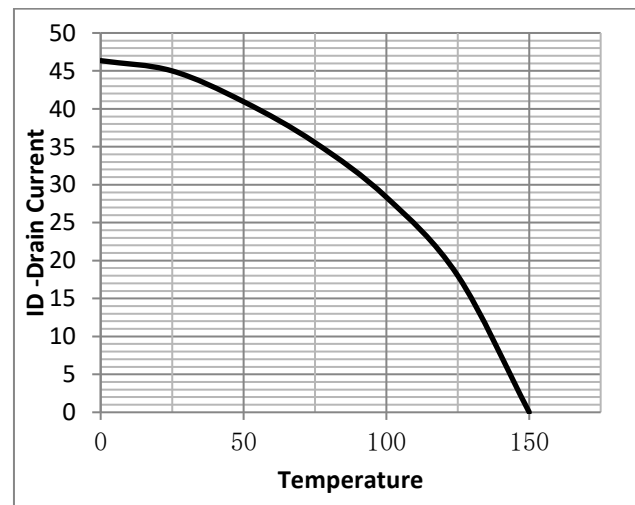

Figure.11 Diode Forward Voltage vs. Current

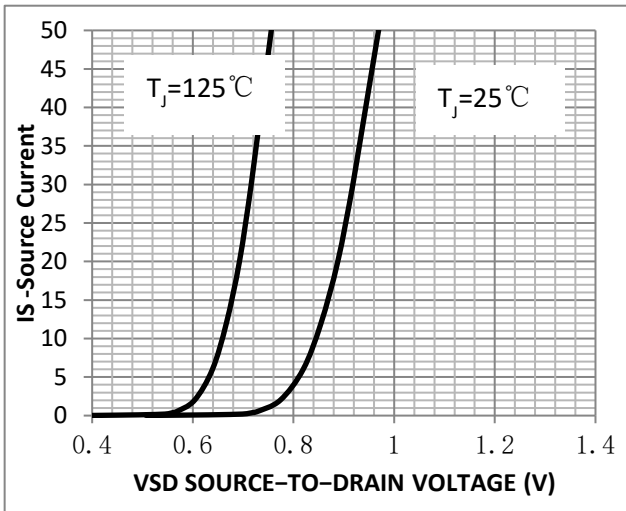

Figure.12 Transfer Characteristics

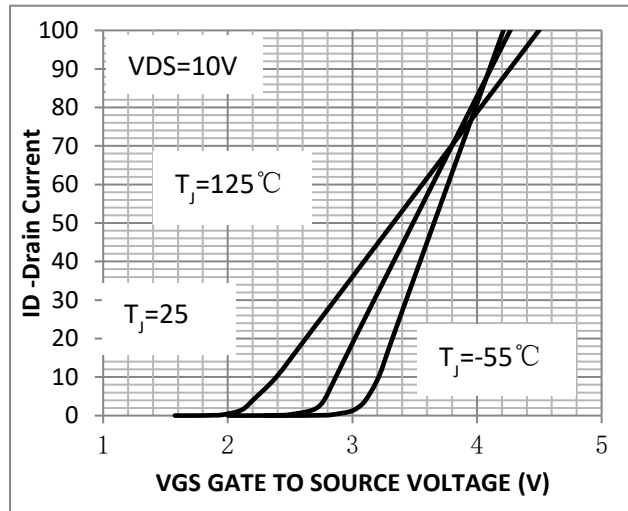

Fig.13 Switching Time Measurement Circuit

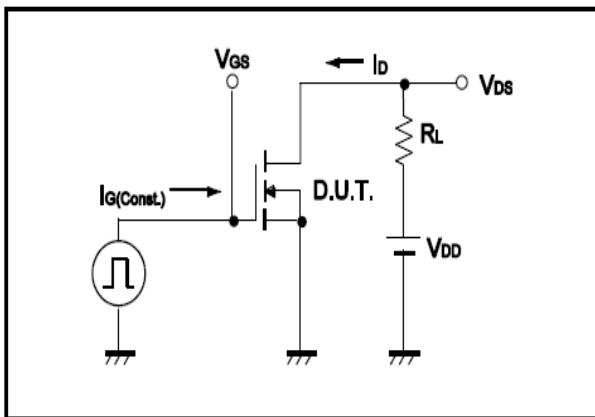

Fig.14 Gate Charge Waveform

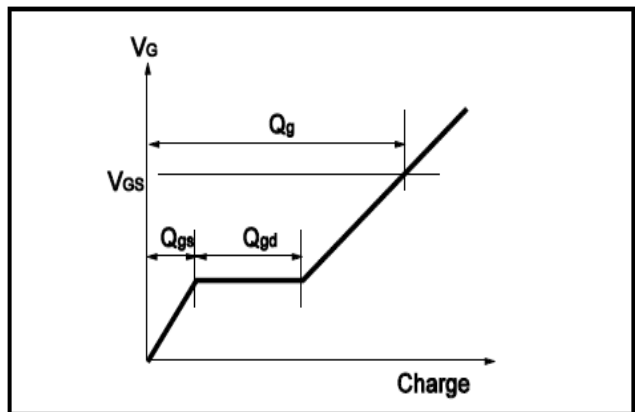

Fig.15 Resistive Switching Test Circuit

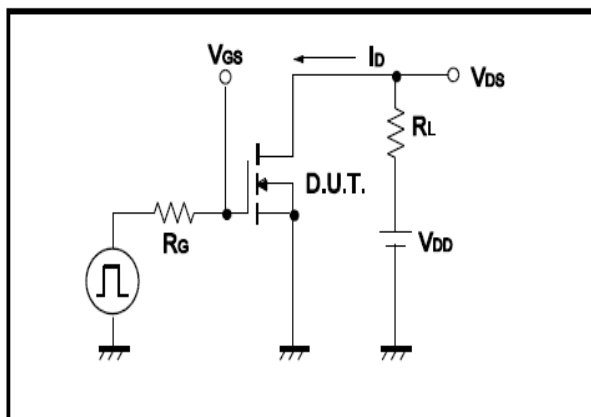

Fig.16 Resistive Switching Test Waveform

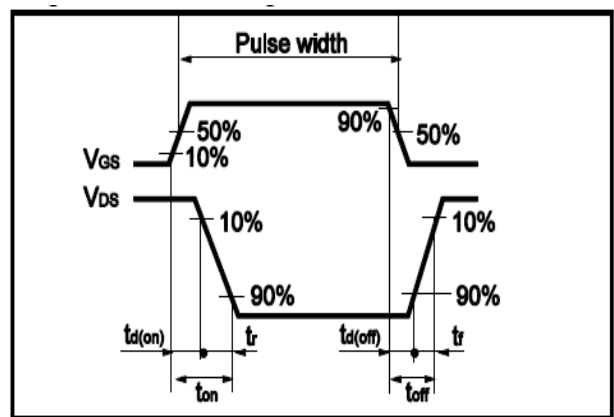



Fig.17 Avalanche Measurement Circuit

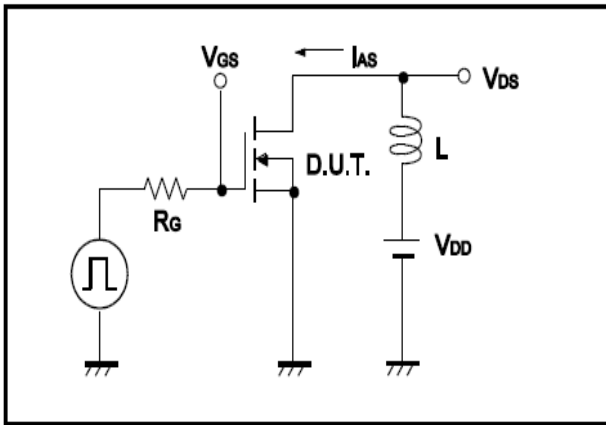
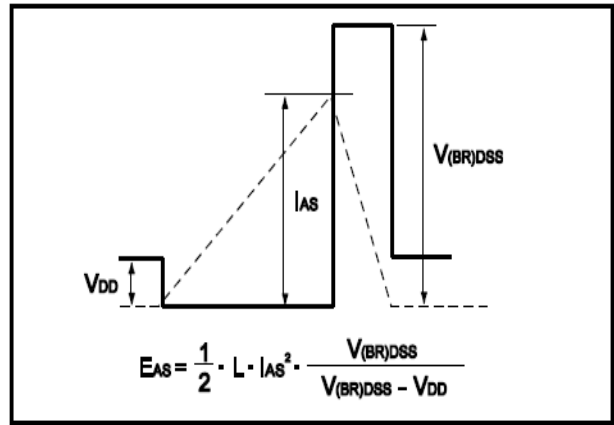

Fig.18 Avalanche Waveform





•Dimensions (DFN5x6)

Unit: mm

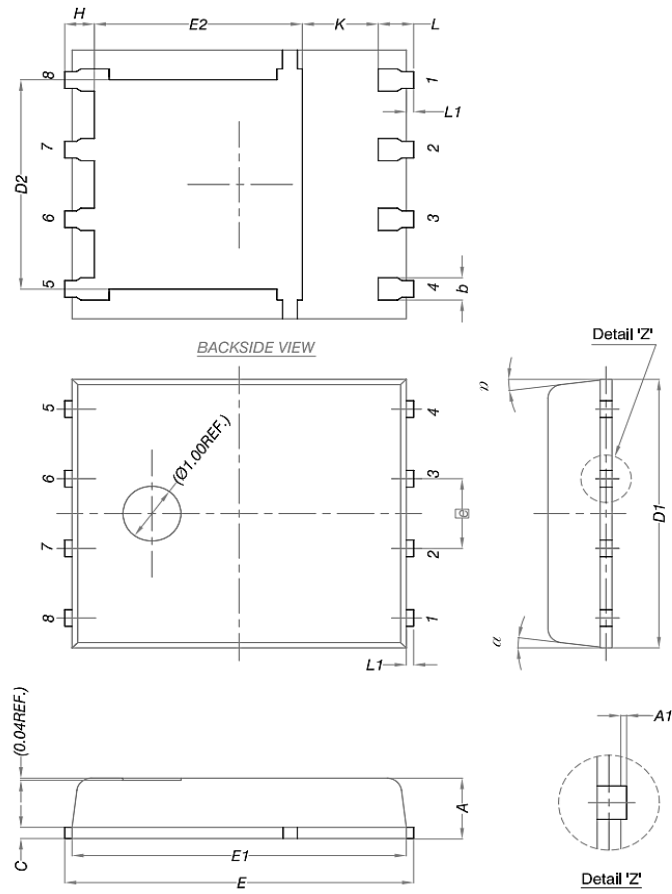

DIM.	MILLIMETERS		
	MIN.	NOM.	MAX.
A	0.90	1.00	1.10
A1	0	-	0.05
b	0.33	0.41	0.51
C	0.20	0.25	0.30
D1	4.80	4.90	5.00
D2	3.61	3.81	3.96
E	5.90	6.00	6.10
E1	5.70	5.75	5.80
E2	3.38	3.58	3.78
e	1.27 BSC		
H	0.41	0.51	0.61
K	1.10	-	-
L	0.51	0.61	0.71
L1	0.06	0.13	0.20
α	0°	-	12°