

• General Description

Advanced trench MOSFET technology with a low resistance package to provide extremely low $R_{DS(ON)}$. one N channel MOSFET and one P channel MOSFET in one package.

• Features

- Advance high cell density Trench technology
- Low $R_{DS(ON)}$ to minimize conductive loss
- Low Gate Charge for fast switching
- Dual DIE in one package

• Application

- Power Management in Notebook Computer
- BLDC Motor driver

• Ordering Information:

Part NO.	ZMC88405S
Marking	ZMC88405
Packing Information	REEL TAPE
Basic ordering unit (pcs)	4000

• Thermal resistance

Parameter	Symbol	Min.	Typ.	Max.	Unit
Thermal resistance, junction - case	R_{thJC}	-	-	34	° C/W
Thermal resistance, junction - ambient	R_{thJA}	-	-	180	° C/W
Soldering temperature, reflow soldering (max)	T_{sold}	-	-	260	° C

• N Channel Absolute Maximum Ratings ($T_C = 25^\circ C$)

Parameter	Symbol	Rating	Unit
Drain-Source Voltage	V_{DS}	40	V
Gate-Source Voltage	V_{GS}	±20	V
Continuous Drain Current	$I_D @ T_C = 25^\circ C$	6.3	A
	$I_D @ T_C = 75^\circ C$	4.8	A
	$I_D @ T_C = 100^\circ C$	4.0	A

• Product Summary

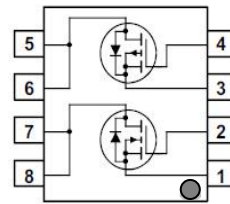

$V_{DS1} = 40V$
 $V_{DS2} = -40V$
 $R_{DS(ON)1} = 20m\Omega$
 $R_{DS(ON)2} = 45m\Omega$
 $I_{D1} = 6.3A$
 $I_{D2} = -4.0A$

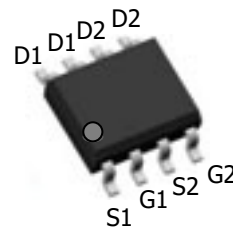

SOP8



Pulsed Drain Current ^①	I_{DM}	18.9	A
Total Power Dissipation	$P_D@T_C=25^\circ C$	3.6	W
Total Power Dissipation	$P_D@T_A=25^\circ C$	0.69	W
Operating Junction Temperature	T_J	-55 to 150	$^\circ C$
Storage Temperature	T_{STG}	-55 to 150	$^\circ C$
Single Pulse Avalanche Energy	E_{AS}	14	mJ

•N Channel Electronic Characteristics

Parameter	Symbol	Condition	Min.	Typ	Max.	Unit
Drain-Source Breakdown Voltage	BV_{DSS}	$V_{GS} = 0V, I_D = 250\mu A$	40			V
Gate Threshold Voltage	$V_{GS(TH)}$	$V_{GS} = V_{DS}, I_D = 250\mu A$	1.4	1.6	2.5	V
Drain-Source Leakage Current	I_{DSS}	$V_{DS} = 40V, V_{GS} = 0V$			1.0	μA
Gate- Source Leakage Current	I_{GSS}	$V_{GS} = \pm 20V, V_{DS} = 0V$			± 100	nA
Static Drain-source On Resistance	$R_{DS(ON)}$	$V_{GS} = 10V, I_D = 6A$		20	28	$m\Omega$
		$V_{GS} = 4.5V, I_D = 4A$		33	45	$m\Omega$
Forward Transconductance	g_{FS}	$V_{DS} = 25V, I_D = 5A$		1.8		S
Source-drain voltage	V_{SD}	$I_S = 6A$			1.28	V

•N Channel Dynamic Characteristics

Parameter	Symbol	Condition	Min.	Typ	Max.	Unit
Input capacitance	C_{iss}	$f = 1MHz,$ $V_{DS} = 25V$	-	805	-	pF
Output capacitance	C_{oss}		-	94	-	
Reverse transfer capacitance	C_{rss}		-	58	-	
Gate Resistance	R_g	$f = 1MHz$		1.2		Ω
Total gate charge	Q_g	$V_{DD} = 15V$ $I_D = 6A$ $V_{GS} = 10V$	-	12	-	nC
Gate - Source charge	Q_{gs}		-	3.1	-	
Gate - Drain charge	Q_{gd}		-	2.8	-	
Turn-ON Delay time	$t_{D(on)}$	$V_{GS} = 10V, V_{DS} = 15V$ $R_G = 6\Omega, I_D = 6A$		6		ns
Turn-ON Rise time	t_r			16		ns
Turn-Off Delay time	$t_{D(off)}$			28		ns
Turn-Off Fall time	t_f			8		ns
Reverse Recovery Time	t_{RR}	$V_{DD} = 20V,$ $dI_S/dt = 100A/\mu s,$ $I_S = 6A$		18		ns
Reverse Recovery Charge	Q_{RR}			11		nC

•P Channel Absolute Maximum Ratings (T_C =25°C)

Parameter	Symbol	Rating	Unit
Drain-Source Voltage	V _{DS}	-40	V
Gate-Source Voltage	V _{GS}	±20	V
Continuous Drain Current	I _D @T _C =25°C	-4	A
	I _D @T _C =75°C	-3.0	A
	I _D @T _C =100°C	-2.5	A
Pulsed Drain Current ^①	I _{DM}	-12	A
Total Power Dissipation	P _D @T _C =25°C	3.6	W
Total Power Dissipation	P _D @T _A =25°C	0.69	W
Operating Junction Temperature	T _J	-55 to 150	°C
Storage Temperature	T _{STG}	-55 to 150	°C
Single Pulse Avalanche Energy	E _{AS}	15	mJ

•P Channel Electronic Characteristics

Parameter	Symbol	Condition	Min.	Typ	Max.	Unit
Drain-Source Breakdown Voltage	BV _{DSS}	V _{GS} =0V, I _D =-250uA	-40			V
Gate Threshold Voltage	V _{GS(TH)}	V _{GS} =V _{DS} , I _D =-250uA	-1.4		-2.5	V
Drain-Source Leakage Current	I _{DSS}	V _{DS} =-40V, V _{GS} =0V			-1.0	uA
Gate- Source Leakage Current	I _{GSS}	V _{GS} =±20V, V _{DS} =0V			±100	nA
Static Drain-source On Resistance	R _{Ds(ON)}	V _{GS} =-10V, I _D =-5A		46	57	mΩ
		V _{GS} =-4.5V, I _D =-4A		70	90	mΩ
Forward Transconductance	g _{FS}	V _{DS} =-10V, I _D =-4A		1.2		s
Source-drain voltage	V _{SD}	I _S =-5A			1.28	V

•P Channel Dynamic Characteristics

Parameter	Symbol	Condition	Min.	Typ	Max.	Unit
Input capacitance	C _{iss}	f = 1MHz, V _{DS} =25V	-	838	-	pF
Output capacitance	C _{oss}		-	94	-	pF
Reverse transfer capacitance	C _{rss}		-	70	-	pF
Gate Resistance	R _g	f = 1MHz		9.3		Ω
Total gate charge	Q _g	V _{DD} = 15V I _D = 5A V _{GS} = 10V	-	15.3	-	nC
Gate - Source charge	Q _{gs}		-	3.6	-	nC
Gate - Drain charge	Q _{gd}		-	2.3	-	nC

Turn-ON Delay time	$t_{D(on)}$	$V_{GS}=10V,$ $V_{DS}=15V$ $R_G =6\Omega,$ $I_D =5A$	13.2	ns
Turn-ON Rise time	t_r		15	ns
Turn-Off Delay time	$t_{D(off)}$		46	ns
Turn-Off Fall time	t_f		19	ns
Reverse Recovery Time	t_{RR}	$V_{DD} = 20 V,$ $dI_S/dt=100A/us,$ $I_S = 5 A$	25	ns
Reverse Recovery Charge	Q_{RR}		20	nC

•N Channel characteristics curve

Fig.1 Power Dissipation Derating Curve

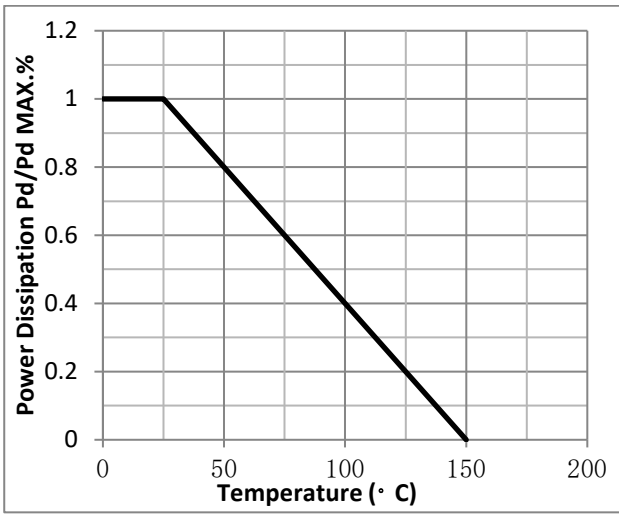

Fig.2 Typical output Characteristics

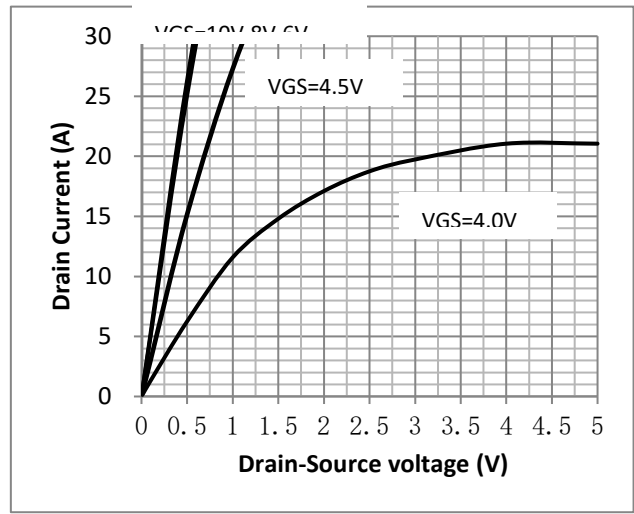

Fig.3 Threshold Voltage V_{gs(th)} V.S Junction Temperature

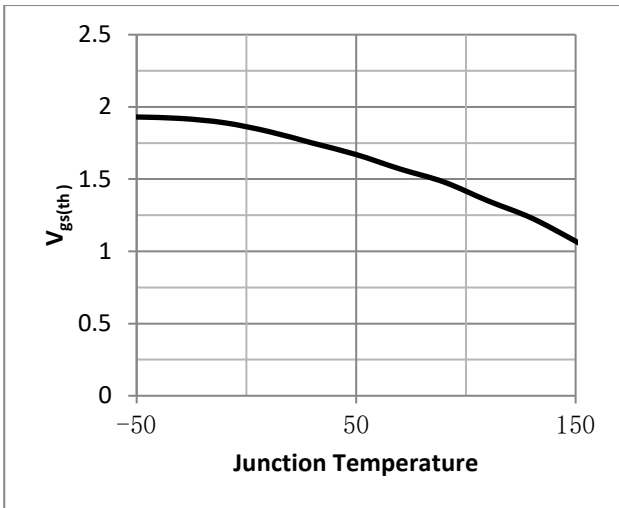

Fig.4 Resistance V.S Drain Current

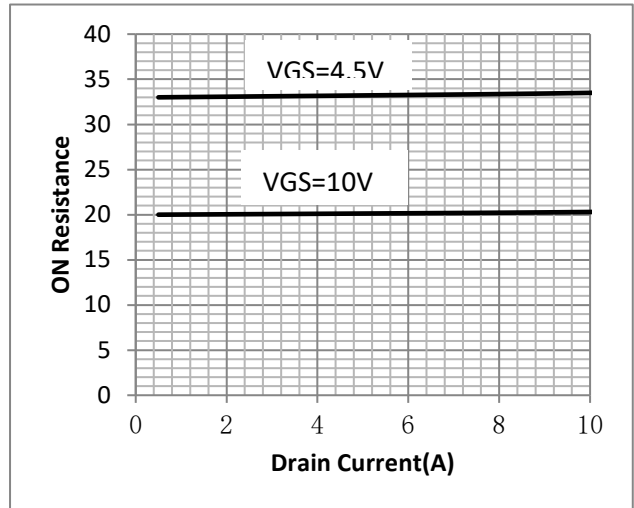

Fig.5 On-Resistance VS Gate Source Voltage

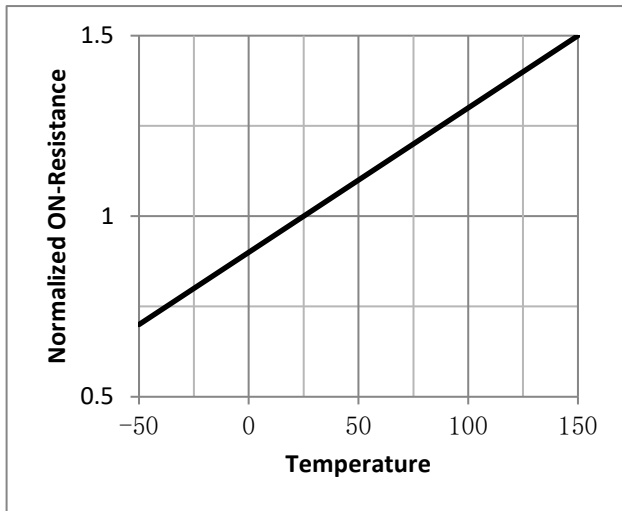

Fig.6 On-Resistance V.S Junction Temperature

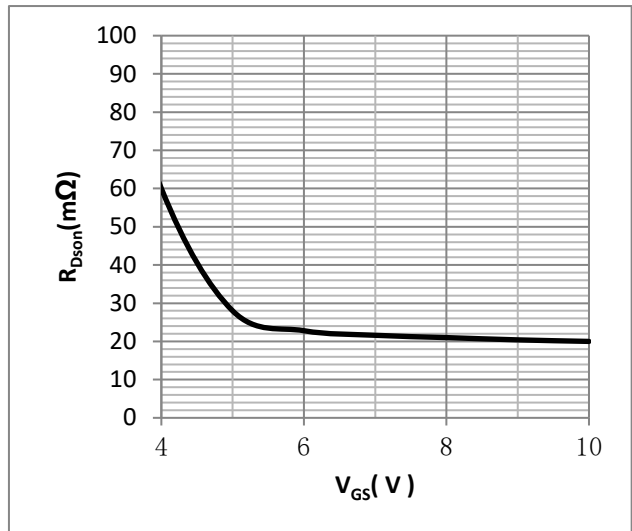

Fig.7 SOA Maximum Safe Operating Area

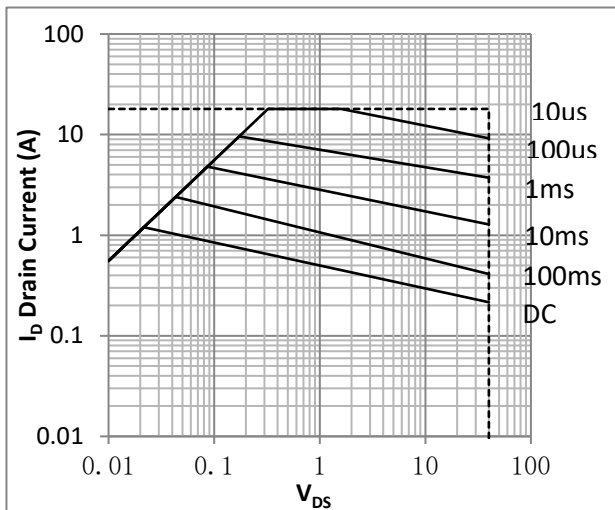

Fig.8 I_D -Junction Temperature

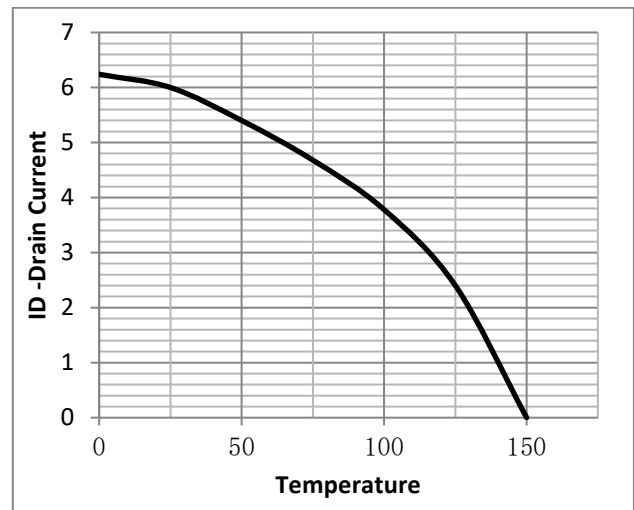

Figure 9. Diode Forward Voltage vs. Current

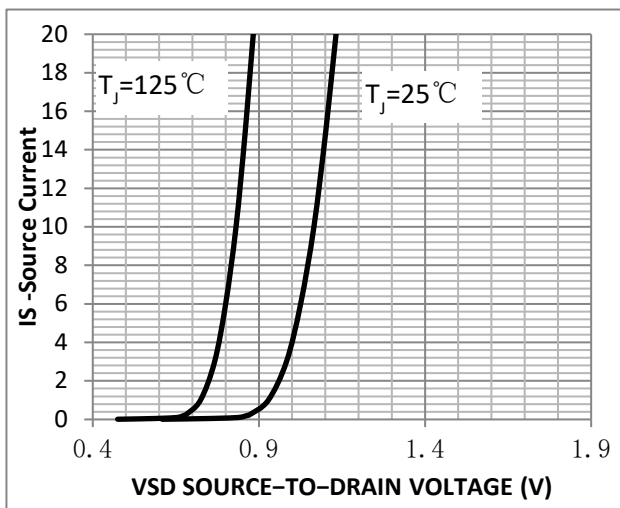

Figure 10. Transfer Characteristics

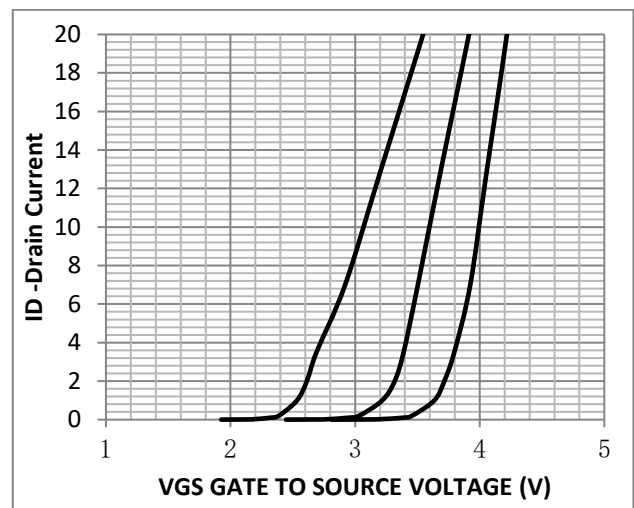

Figure 11. Gate-to-Source and Drain-to-Source Voltage vs. Total Charge

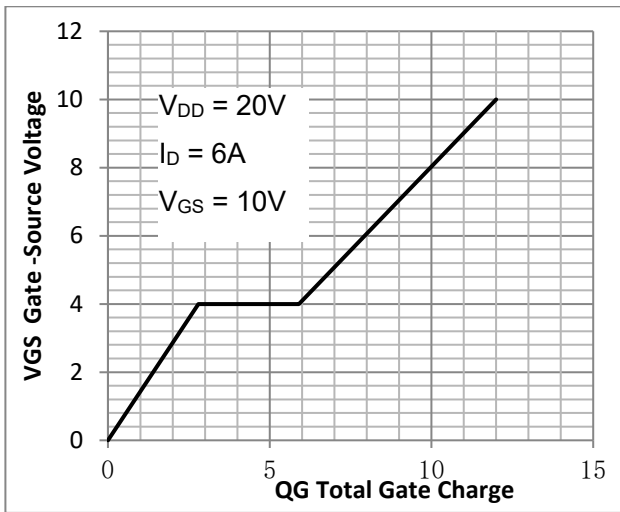
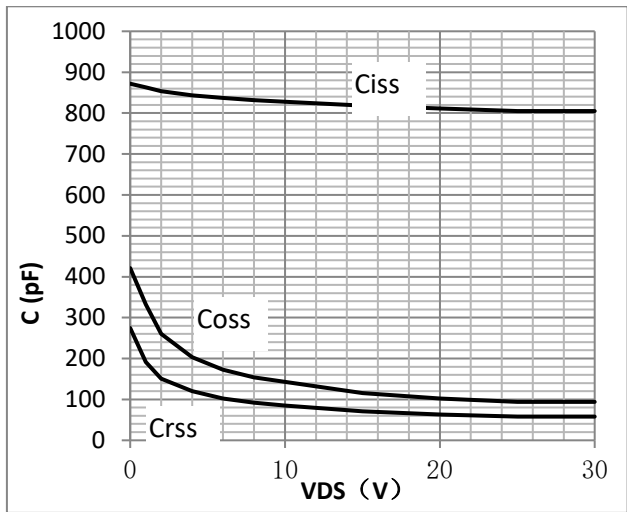

Fig.12 Capacitance Variation



•P Channel characteristics curve

Fig.1 Power Dissipation Derating Curve

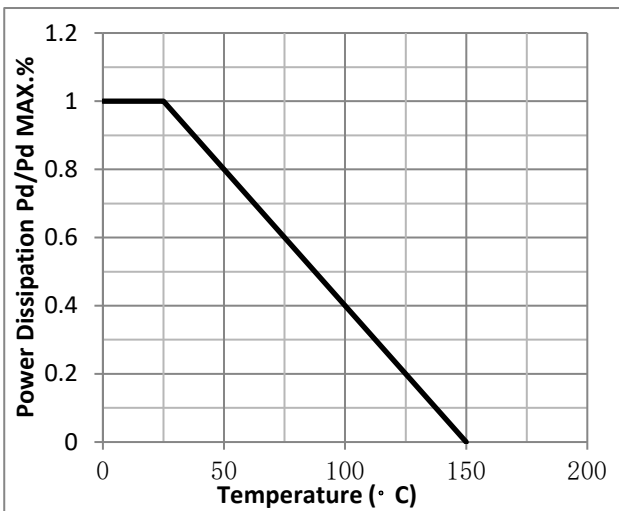

Fig.2 Typical output Characteristics

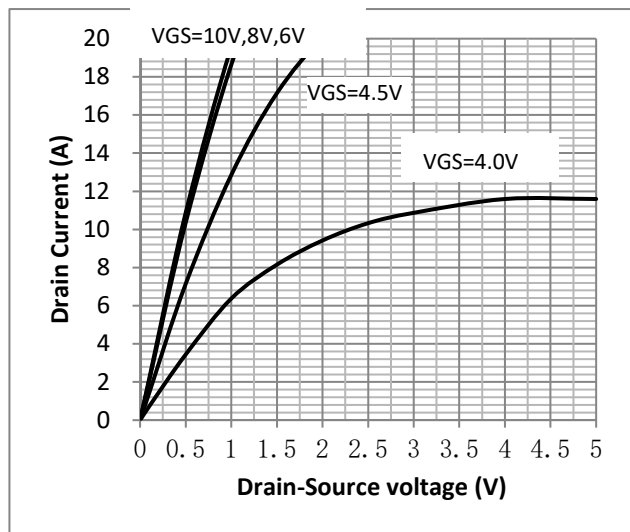

Fig.3 Threshold Voltage V.S Junction Temperature

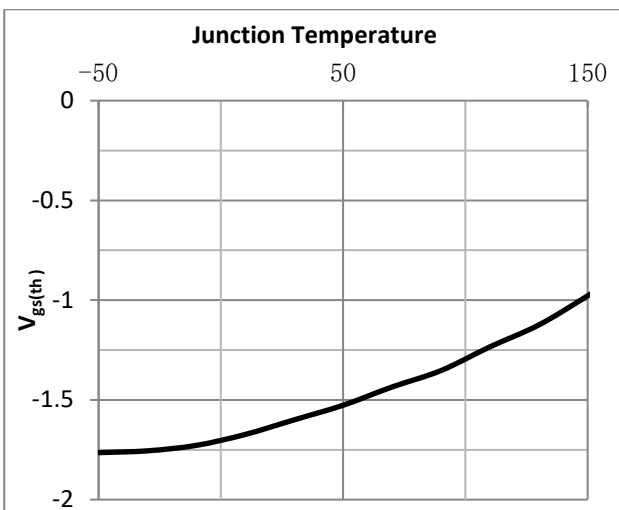

Fig.4 Resistance V.S Drain Current

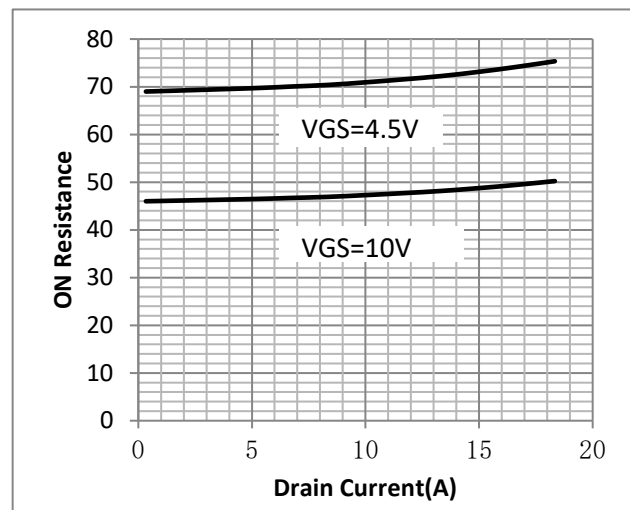

Fig.5 On-Resistance VS Gate Source Voltage

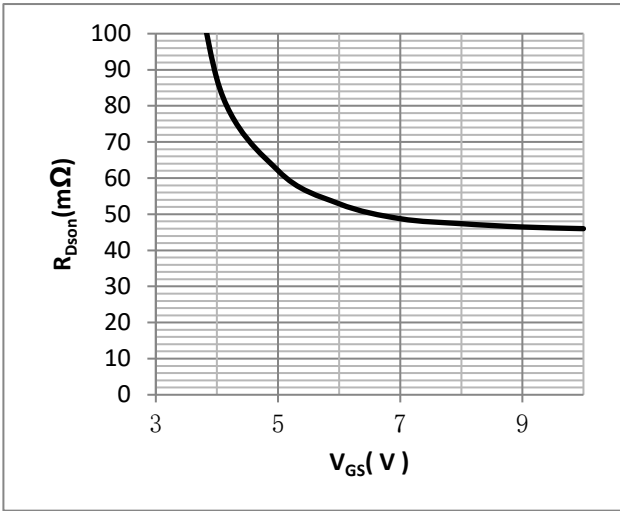

Fig.6 On-Resistance V.S Junction Temperature

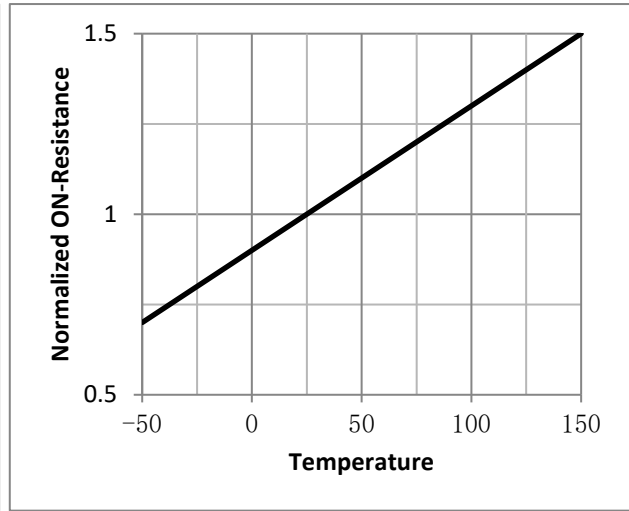

Fig.7 SOA Maximum Safe Operating Area

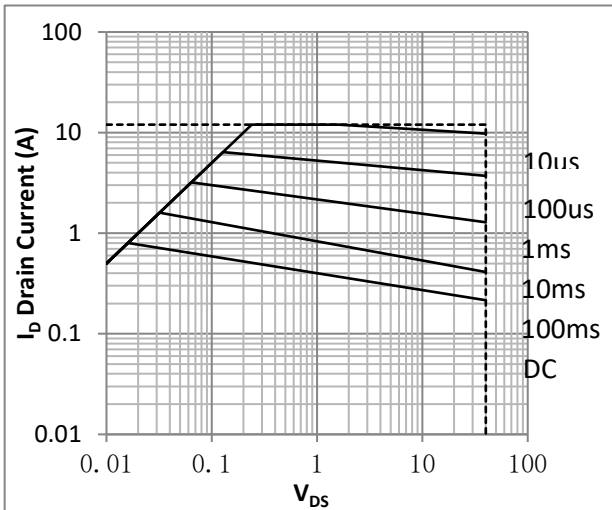

Fig.8 I_D-Junction Temperature

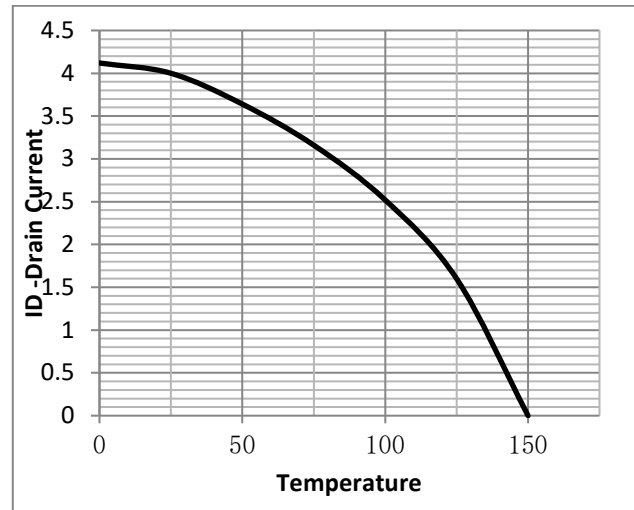

Figure 9. Diode Forward Voltage vs. Current

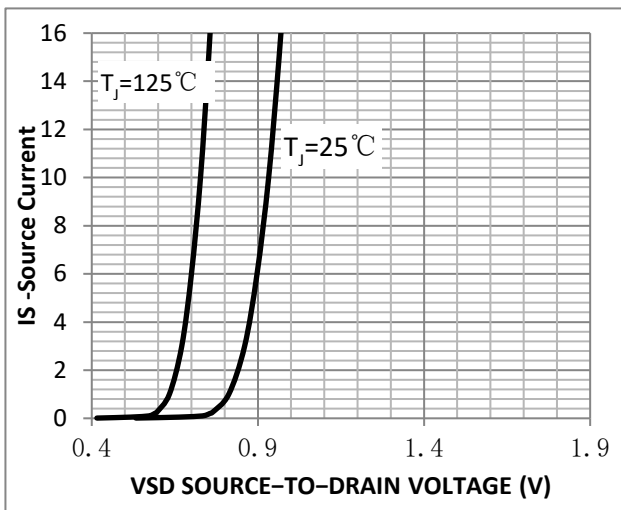

Figure 10. Transfer Characteristics

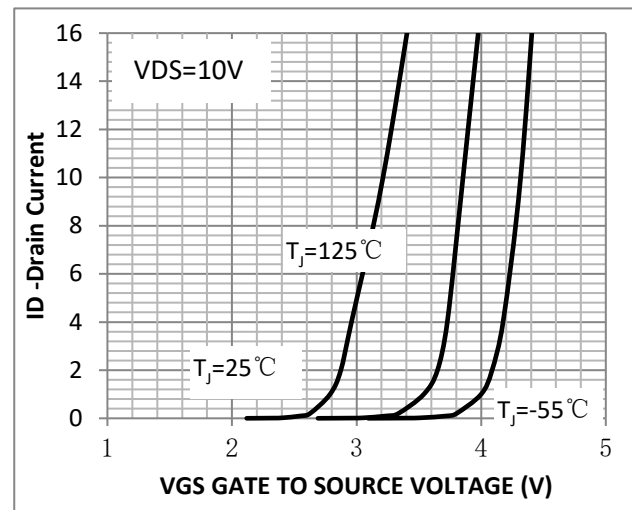

Figure 11. Gate-to-Source and Drain-to-Source Voltage vs. Total Charge

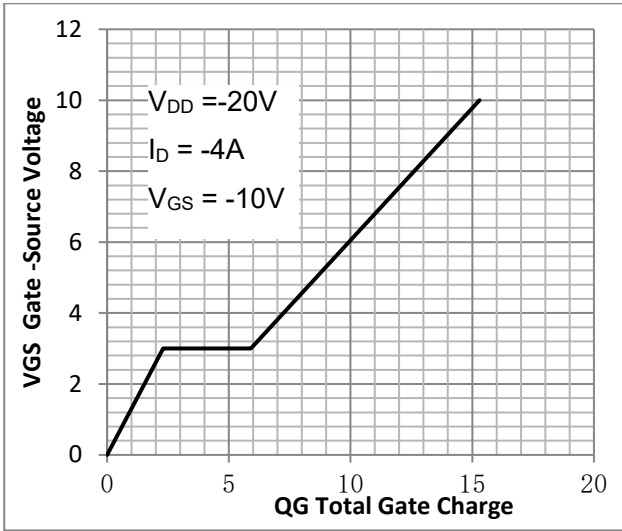
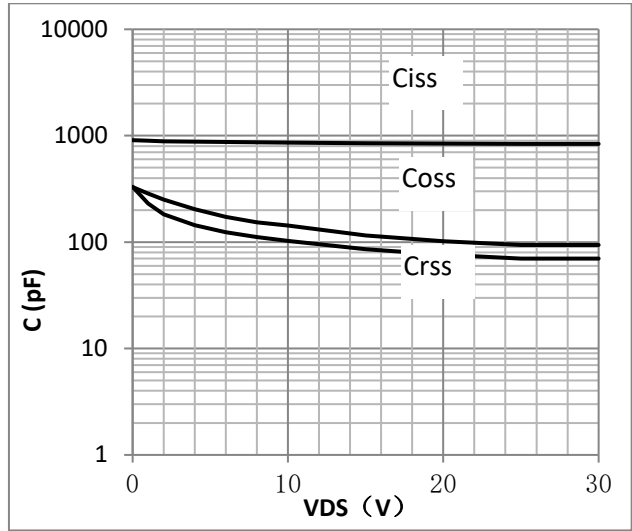

Fig.12 Capacitance Variation



•Test Circuit

Fig.1 Switching Time Measurement Circuit

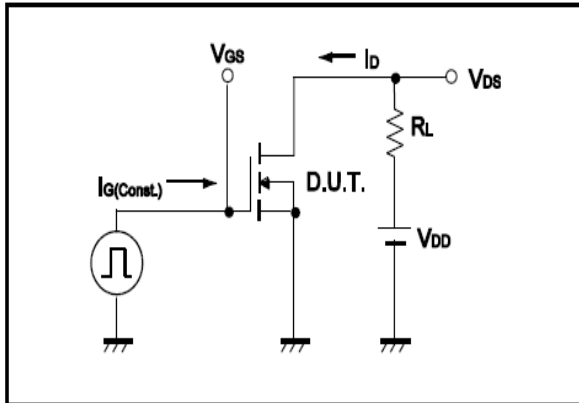

Fig.2 Gate Charge Waveform

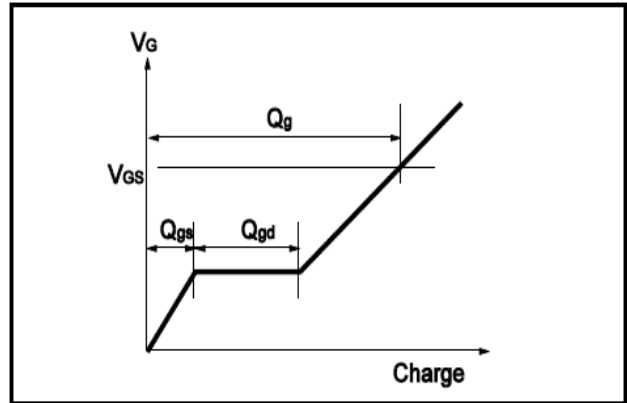

Fig.3 Switching Time Measurement Circuit

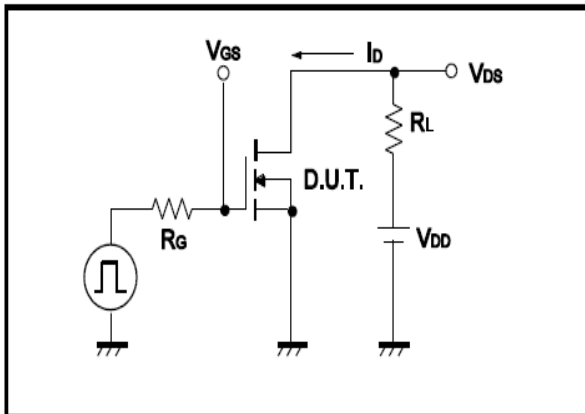

Fig.4 Gate Charge Waveform

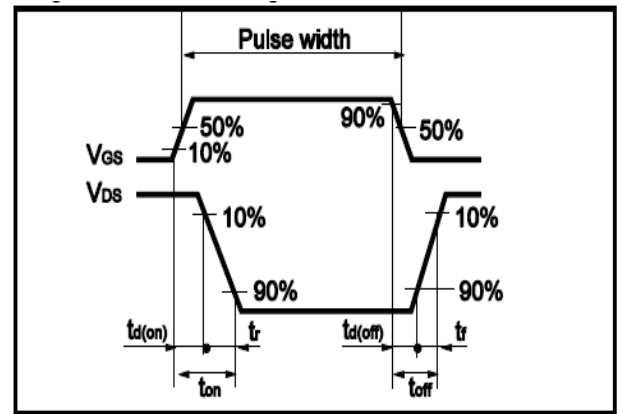

Fig.5 Avalanche Measurement Circuit

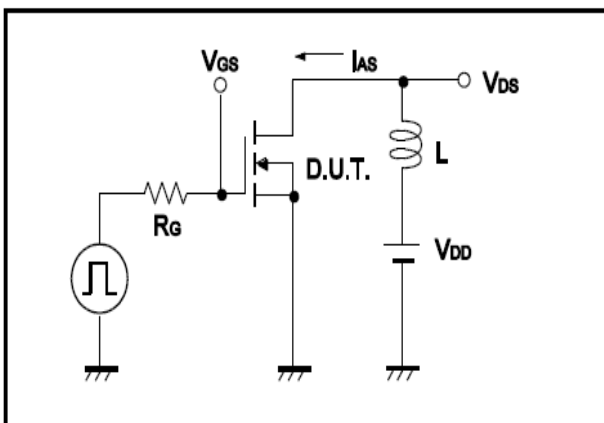
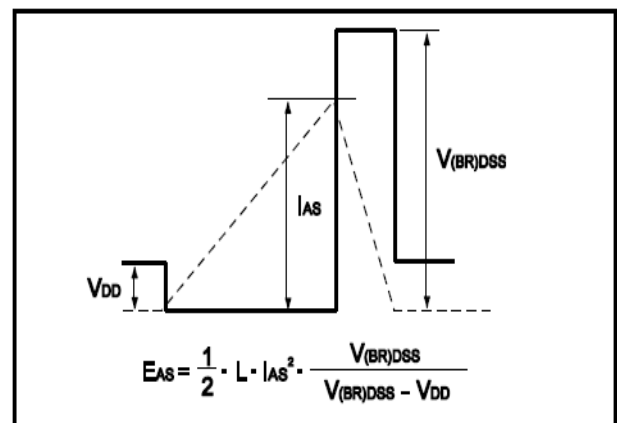

Fig.6 Avalanche Waveform





●Dimensions(SOP8)

Unit: mm

SYMBOL	min	TYP	max	SYMBOL	min		max
A	4.80		5.25	C	1.30		1.75
A1	0.37		0.49	C1	0.55		0.75
A2		1.27		C2	0.55		0.65
A3		0.41		C3	0.05		0.20
B	5.80		6.20	C4	0.10	0.20	0.23
B1	3.80		4.10	D		1.05	
B2		5.00		D1	0.40		0.62

