

• General Description

The ZM020N04HP combines advanced trench MOSFET technology with a low resistance package to provide extremely low $R_{DS(ON)}$.

• Features

- Advance high cell density Trench technology
- Low $R_{DS(ON)}$ to minimize conductive loss
- Low Gate Charge for fast switching
- Low Thermal resistance

• Application

- Synchronous Rectification
- Power Management in Inverter System
- POL application
- BLDC Motor driver

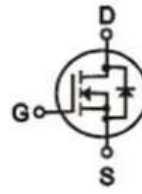
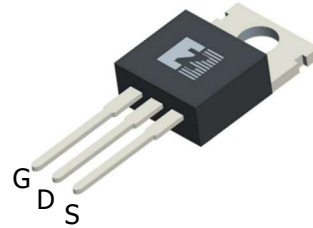
• Product Summary

 $V_{DS}=40V$
 $R_{DS(ON)} = 2.2m\Omega$
 $I_D=180A$

TO-220

• Ordering Information:

Part NO.	ZM020N04HP
Marking	ZM020N04H
Packing Information	Bulk Tube
Basic ordering unit (pcs)	1000

• Absolute Maximum Ratings ($T_C = 25^\circ C$)

Parameter	Symbol	Rating	Unit
Drain-Source Voltage	V_{DS}	40	V
Gate-Source Voltage	V_{GS}	± 20	V
Continuous Drain Current	$I_{D@TC=25^\circ C}$	180	A
	$I_{D@TC=75^\circ C}$	137	A
	$I_{D@TC=100^\circ C}$	113	A
Pulsed Drain Current ^①	I_{DM}	540	A
Total Power Dissipation($TC=25^\circ C$)	$P_D@TC=25^\circ C$	100	W
Total Power Dissipation($TA=25^\circ C$)	$P_D@TA=25^\circ C$	5	W
Operating Junction Temperature	T_J	150	$^\circ C$
Storage Temperature	T_{STG}	150	$^\circ C$
Single Pulse Avalanche Energy	E_{AS}	245	mJ
Avalanche Current	I_{AS}	70	A

•Thermal resistance

Parameter	Symbol	Min.	Typ.	Max.	Unit
Thermal resistance, junction - case	R_{thJC}	-	-	1.25	$^{\circ}C/W$
Thermal resistance, junction - ambient	R_{thJA}	-	-	32	$^{\circ}C/W$
Soldering temperature, wave soldering for 10s	T_{sold}	-	-	265	$^{\circ}C$

•Electronic Characteristics

Parameter	Symbol	Condition	Min.	Typ	Max.	Unit
Drain-Source Breakdown Voltage	BV_{DSS}	$V_{GS} = 0V, I_D = 250\mu A$	40			V
Gate Threshold Voltage	$V_{GS(TH)}$	$V_{GS} = V_{DS}, I_D = 250\mu A$	2.0		4.0	V
Drain-Source Leakage Current	I_{DSS}	$V_{DS} = 40V, V_{GS} = 0V$			1.0	μA
Gate- Source Leakage Current	I_{GSS}	$V_{GS} = \pm 20V, V_{DS} = 0V$			100	nA
Static Drain-source On Resistance	$R_{DS(ON)}$	$V_{GS} = 10V, I_D = 70A$		2.2	3	$m\Omega$
		$V_{GS} = 4.5V, I_D = 30A$		3	4	$m\Omega$
Diode Forward Voltage	V_{FSD}	$I_{SD} = 20A, V_{GS} = 0V$			1.3	V

•Electronic Characteristics

Parameter	Symbol	Condition	Min.	Typ	Max.	Unit
Input capacitance	C_{iss}	$V_{GS} = 0V$ $V_{DS} = 25V$ $f = 1MHz$	-	5580	-	pF
Output capacitance	C_{oss}		-	480	-	
Reverse transfer capacitance	C_{rss}		-	275	-	

•Gate Charge characteristics($T_a = 25^{\circ}C$)

Parameter	Symbol	Condition	Min.	Typ	Max.	Unit
Total gate charge	Q_g	$V_{DD} = 20V$ $I_D = 20A$ $V_{GS} = 10V$	-	70	-	nC
Gate - Source charge	Q_{gs}		-	17	-	
Gate - Drain charge	Q_{gd}		-	12	-	

Note: ① Pulse Test : Pulse width $\leq 300\mu s$, Duty cycle $\leq 2\%$;

Fig.1 Gate-Charge Characteristics

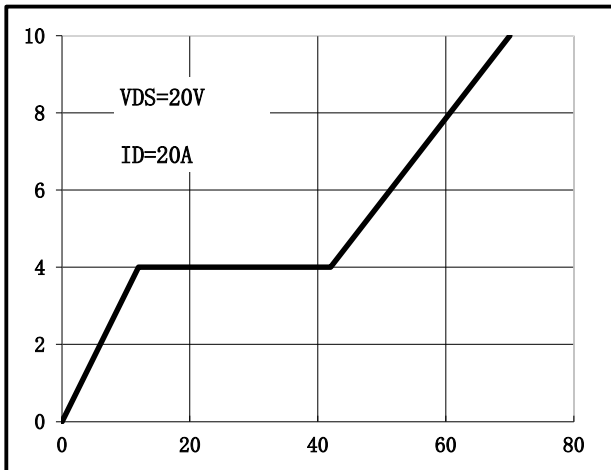

Fig.2 Capacitance Characteristics

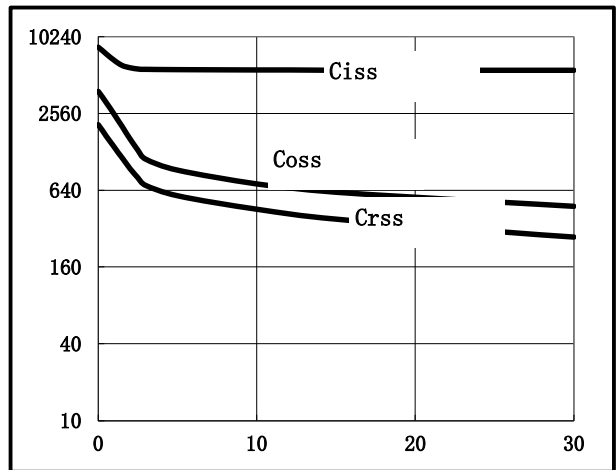

Fig.3 Power Dissipation

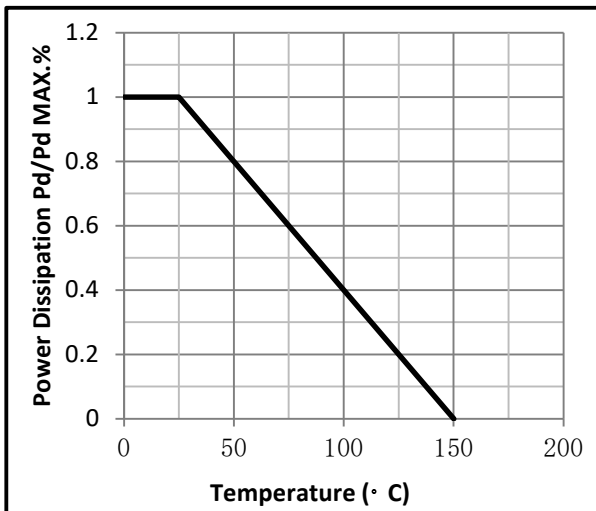

Fig.4 Typical output Characteristics

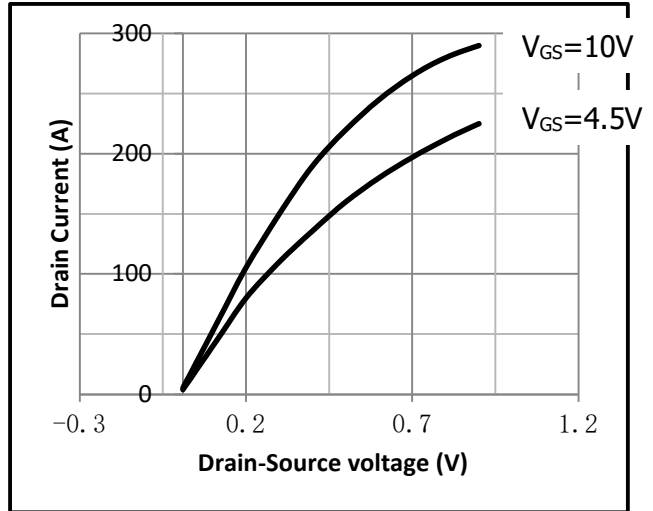

Fig.5 Threshold Voltage V.S Junction Temperature

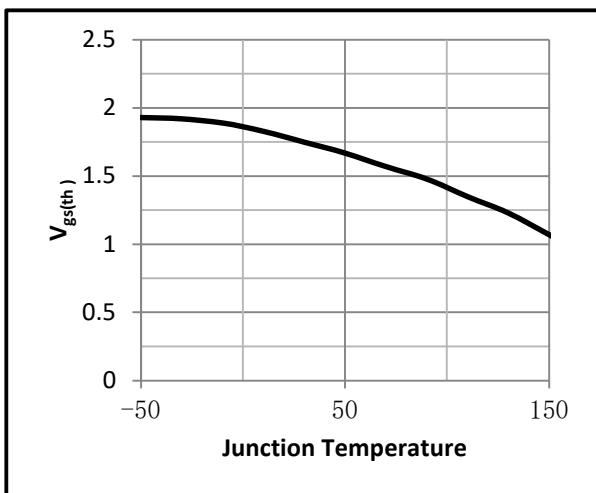

Fig.6 Resistance V.S Drain Current

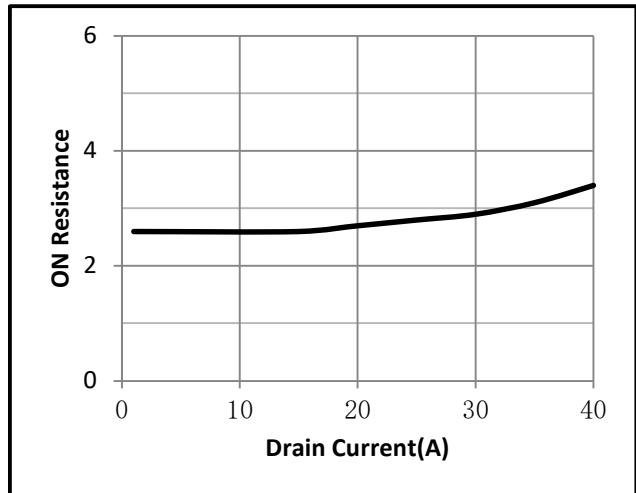

Fig.7 On-Resistance VS Gate Source Voltage

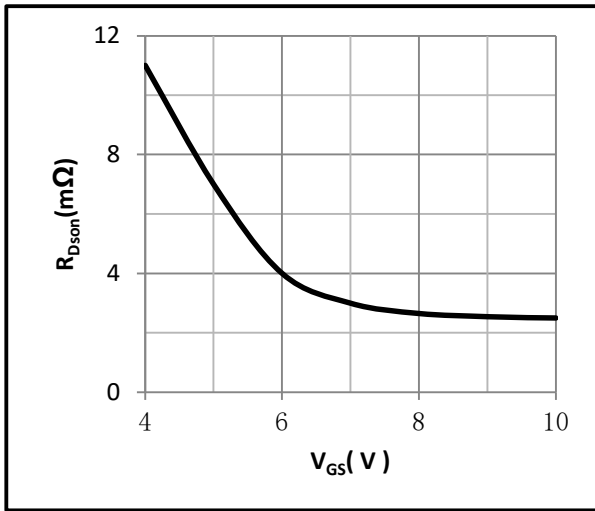

Fig.8 On-Resistance V.S Junction Temperature

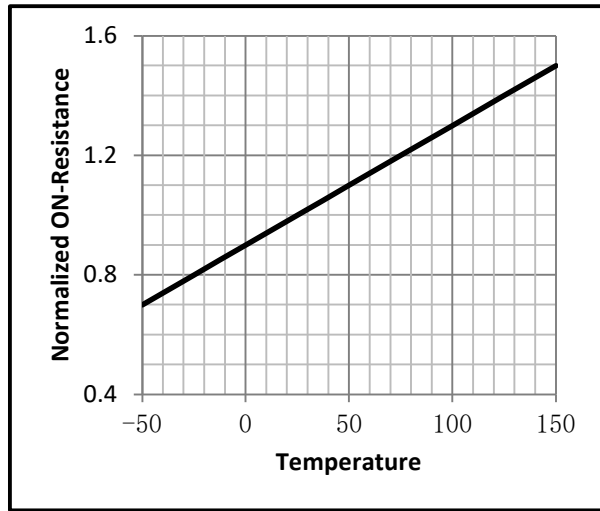

Fig.9 SOA Maximum Safe Operating Area

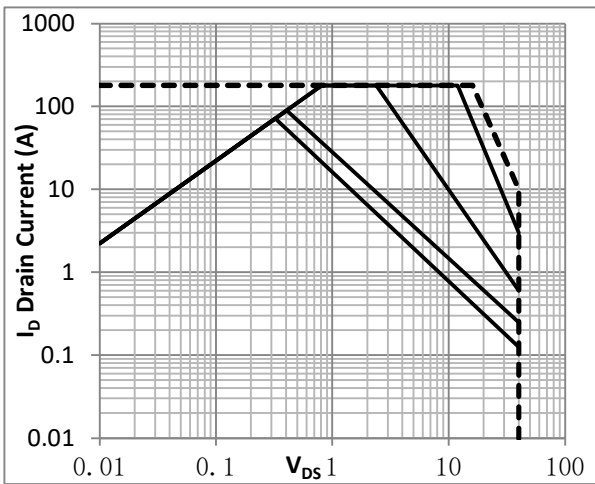

Fig.10 I_D -Junction Temperature

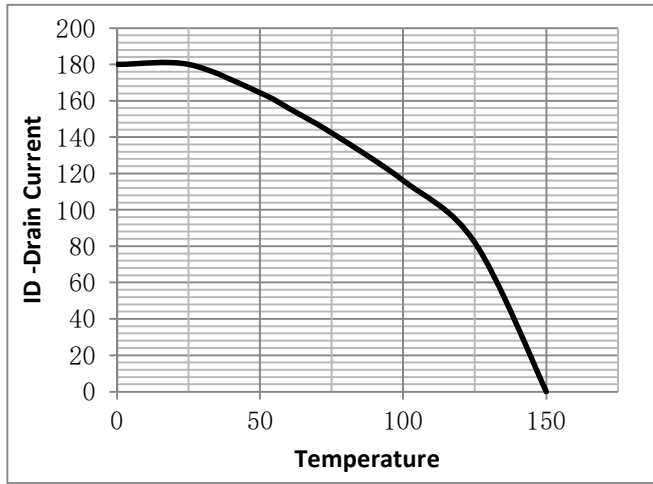

Fig.11 Gate Charge Measurement Circuit

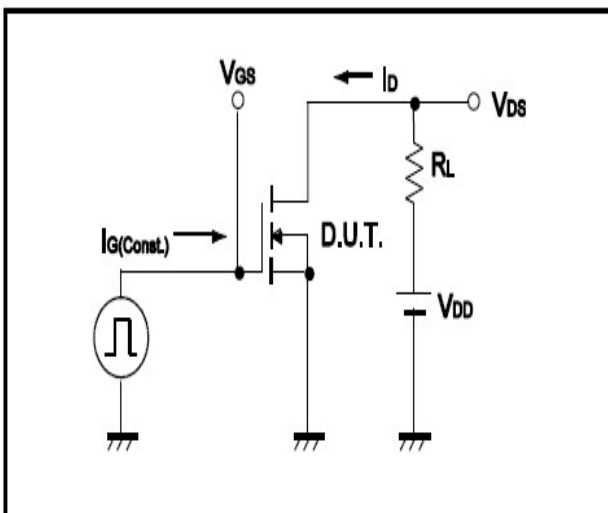

Fig.12 Gate Charge Waveform

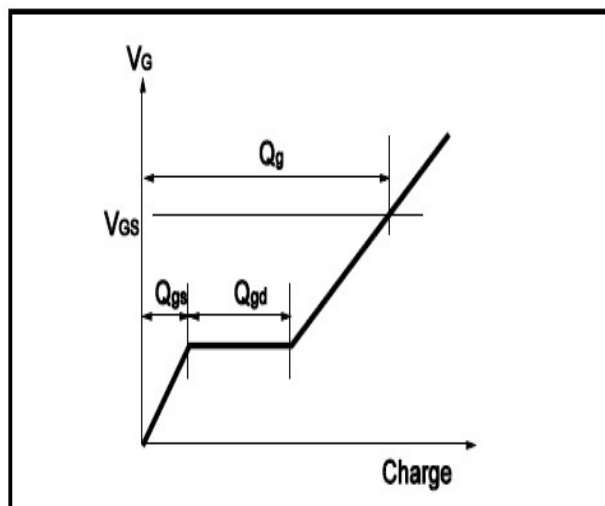

Fig.13 Resistive Switching Test Circuit

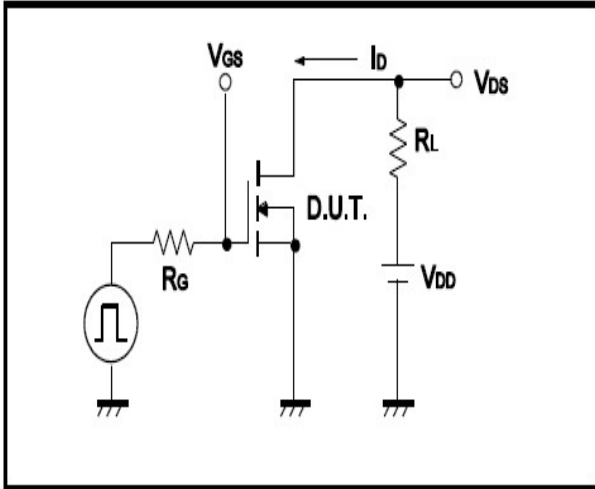
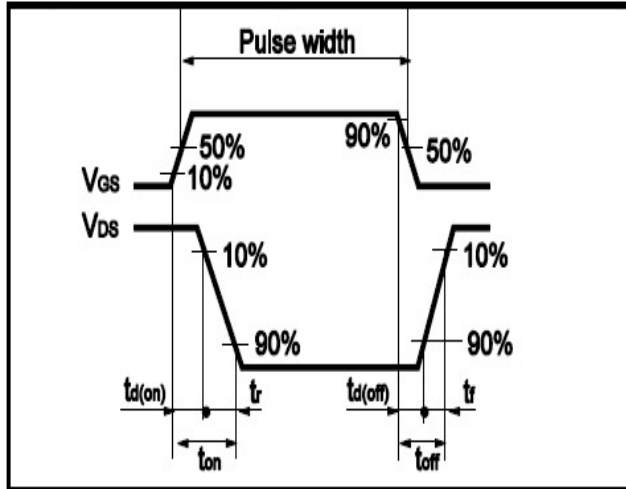

Fig.14 Resistive Switching Test Waveform



•Dimensions (TO-220)

Unit: mm

SYMBOL	min	nom	max	SYMBOL	min	nom	max
A	4.00		4.80	E	9.90		10.70
B	1.20		1.50	e		2.54	
B1	1.00		1.40	F	1.10		1.45
b1	0.65		1.00	L	12.50		14.50
c	0.35		0.75	L1	3.00	3.50	4.00
D	15.00		16.50	Q	2.50		3.00
D1	5.90		6.90	Q1	2.00		3.00
				ΦP	3.60		3.90

