

**• General Description**

The ZM098N06HD combines advanced trench MOSFET technology with a low resistance package to provide extremely low  $R_{DS(ON)}$ .

**• Features**

- Advance high cell density Trench technology
- Low  $R_{DS(ON)}$  to minimize conductive loss
- Low Gate Charge for fast switching
- Low Thermal resistance

**• Application**

- SMPS 2<sup>nd</sup> Synchronous Rectifier
- BLDC Motor driver

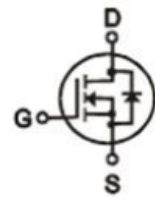
**• Product Summary**

$V_{DS} = 75V$

$R_{DS(ON)} = 13m\Omega$

$I_D = 60A$

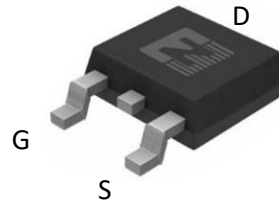
**TO-252**
**• Ordering Information:**

Part NO.	ZM098N06HD
Marking	ZM098N06
Packing Information	REEL TAPE
Basic ordering unit (pcs)	2500

**• Absolute Maximum Ratings (T<sub>C</sub> =25°C)**

Parameter	Symbol	Rating	Unit
Drain-Source Voltage	$V_{DS}$	75	V
Gate-Source Voltage	$V_{GS}$	±20	V
Continuous Drain Current	$I_D@TC=25^\circ C$	60	A
	$I_D@TC=75^\circ C$	45	A
	$I_D@TC=100^\circ C$	38	A
Pulsed Drain Current <sup>①</sup>	$I_{DM}$	140	A
Total Power Dissipation(TC=25°C)	$P_D@TC=25^\circ C$	70	W
Total Power Dissipation(TA=25°C)	$P_D@TA=25^\circ C$	2.8	W
Operating Junction Temperature	$T_J$	-55 to 150	°C
Storage Temperature	$T_{STG}$	-55 to 150	°C
Avalanche Current	$I_{AS} I_{AR}$	40	A

**•Thermal resistance**

Parameter	Symbol	Min.	Typ.	Max.	Unit
Thermal resistance, junction - case	$R_{thJC}$	-	-	1.8	$^{\circ}C/W$
Thermal resistance, junction - ambient	$R_{thJA}$	-	-	45	$^{\circ}C/W$
Soldering temperature, wavesoldering for 10s	$T_{sold}$	-	-	265	$^{\circ}C$

**•Electronic Characteristics**

Parameter	Symbol	Condition	Min.	Typ	Max.	Unit
Drain-Source Breakdown Voltage	$BV_{DSS}$	$V_{GS}=0V, I_D=250\mu A$	75			V
Gate Threshold Voltage	$V_{GS(TH)}$	$V_{GS}=V_{DS}, I_D=250\mu A$	2		4	V
Drain-Source Leakage Current	$I_{DSS}$	$V_{DS}=75V, V_{GS}=0V$			1.0	$\mu A$
Gate- Source Leakage Current	$I_{GSS}$	$V_{GS}=\pm 20V, V_{DS}=0V$			$\pm 100$	nA
Static Drain-source On Resistance	$R_{DS(ON)}$	$V_{GS}=10V, I_D=24A$		13	16	m $\Omega$
Forward Transconductance	$g_{FS}$	$V_{DS}=25V, I_D=10A$		25		S
Source-drain voltage	VSD	$I_S=24A$			1.28	V

**•Electronic Characteristics**

Parameter	Symbol	Condition	Min.	Typ	Max.	Unit
Input capacitance	$C_{iss}$	$V_{GS}=0V, V_{DS}=25V$ $f = 1MHz$	-	2750	-	pF
Output capacitance	$C_{oss}$		-	185	-	
Reverse transfer capacitance	$C_{rss}$		-	135	-	

**Gate Charge characteristics(Ta= 25°C)**

Parameter	Symbol	Condition	Min.	Typ	Max.	Unit
Total gate charge	$Q_g$	$V_{DD}=25V$ $I_D=8A$ $V_{GS}=10V$	-	30	-	nC
Gate - Source charge	$Q_{gs}$		-	9	-	
Gate - Drain charge	$Q_{gd}$		-	15	-	

Note: ① Pulse Test : Pulse width  $\leq 300\mu s$ , Duty cycle  $\leq 2\%$  ;

Fig.1 Gate-Charge Characteristics

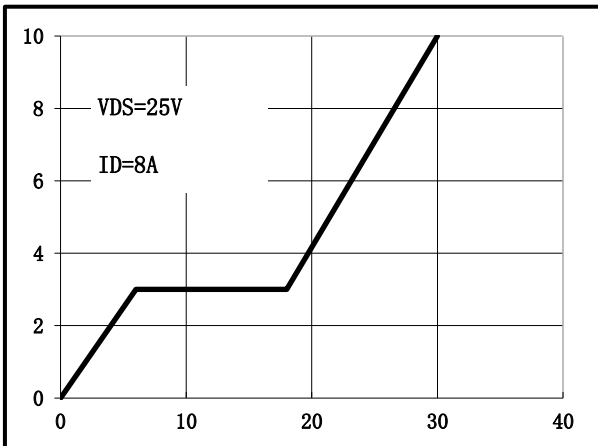

Fig.2 Capacitance Characteristics

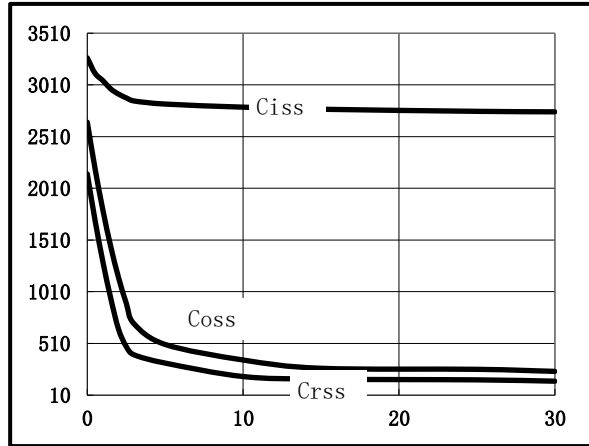

Fig.3 Power Dissipation

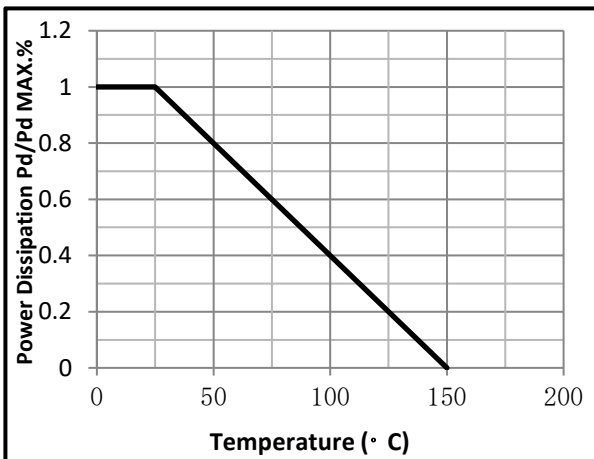

Fig.4 Typical output Characteristics

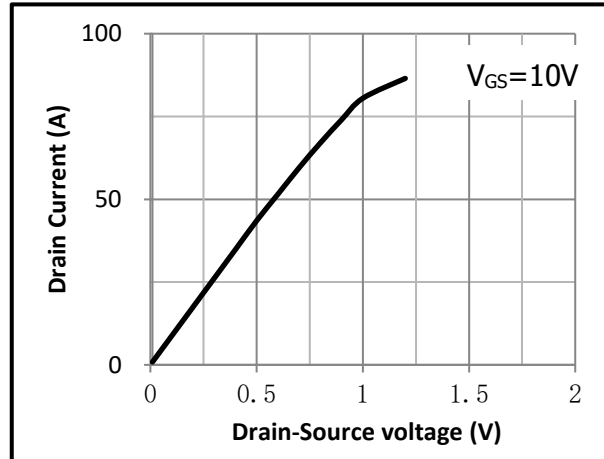

Fig.5 Threshold Voltage V.S Junction Temperature

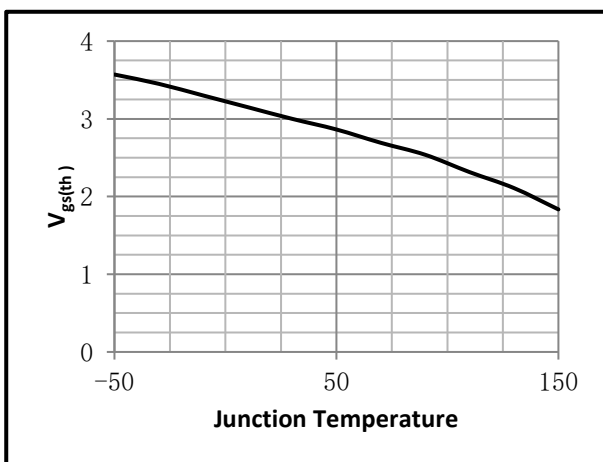

Fig.6 Resistance V.S Drain Current

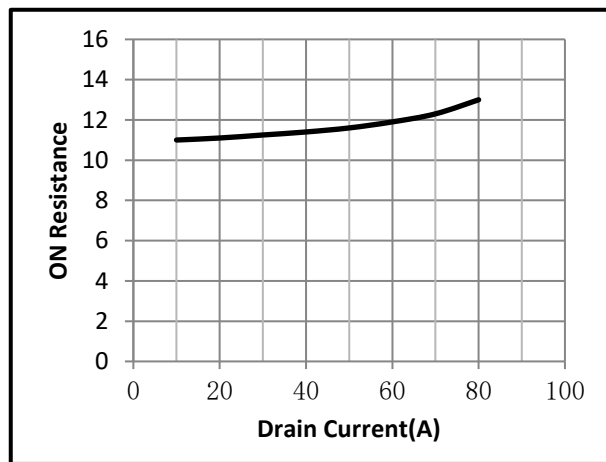

Fig.7 On-Resistance VS Gate Source Voltage

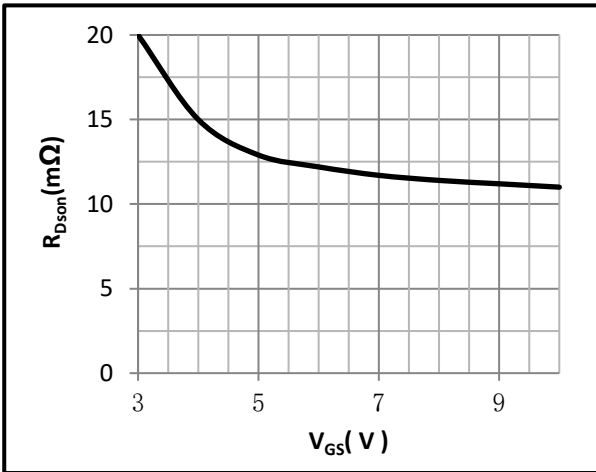

Fig.8 On-Resistance V.S Junction Temperature

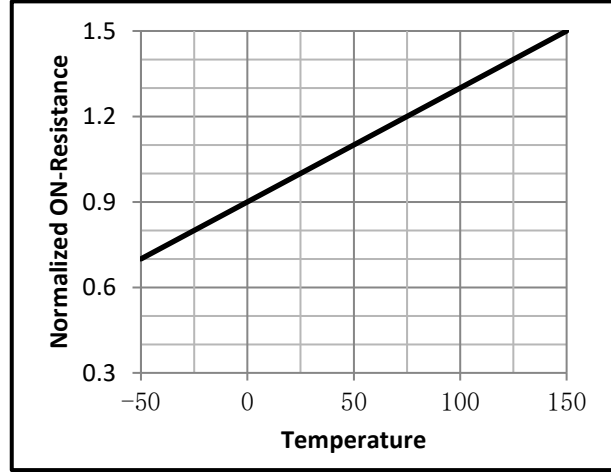

Fig.9 Switching Time Measurement Circuit

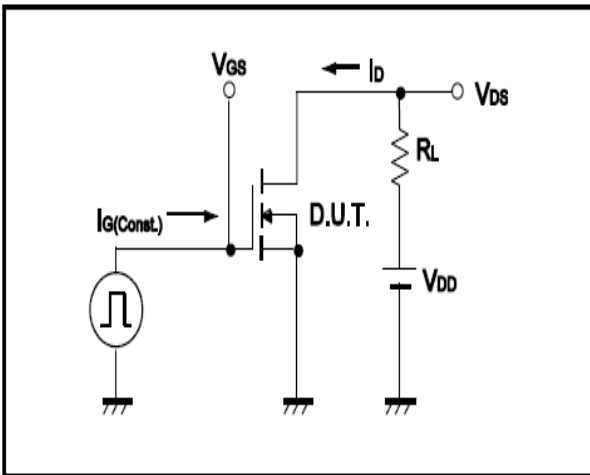

Fig.10 Gate Charge Waveform

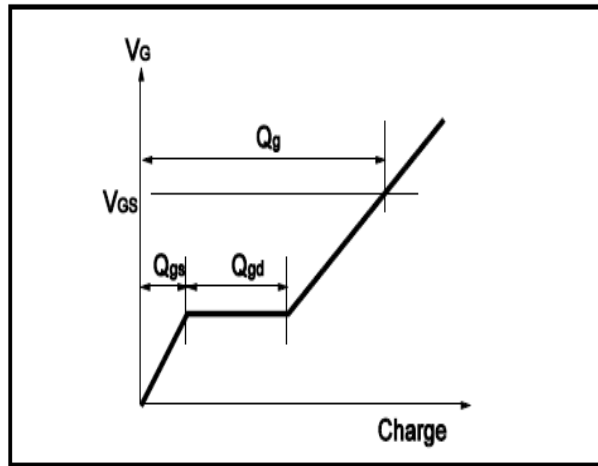

Fig.11 Switching Time Measurement Circuit

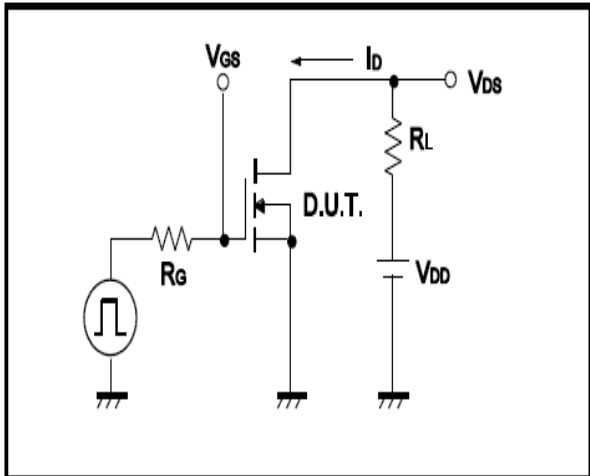
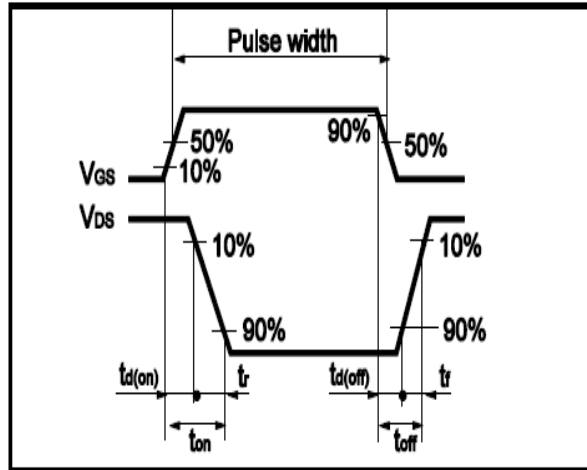

Fig.12 Gate Charge Waveform





•Dimensions(TO-252)

Unit: mm

SYMBOL	min	max	SYMBOL	min	max
A	2.10	2.50	B	0.85	1.25
b	0.50	0.80	b1	0.50	0.90
b2	0.45	0.70	C	0.45	0.70
D	6.30	6.75	D1	5.10	5.50
E	5.30	6.30	e1	2.25	2.35
L1	9.20	10.60	e2	4.45	4.75
L2	0.90	1.75	L3	0.60	1.10
K	0.00	0.23			

